

*Spectroscopic Vision  
System  
Epson SV Tools*

Rev.4

ENM22XS5494F

Original instructions

Spectroscopic Vision System Epson SV Tools Rev.4

# *Spectroscopic Vision System Epson SV Tools*

Rev.4

## FOREWORD

Thank you for purchasing our Epson Spectroscopic Vision Tools (hereinafter “Epson SV Tools”).

This manual contains the information necessary for the correct use of Epson SV Tools.

Please carefully read this manual and other related manuals when using this software.

Keep this manual handy for easy access at all times and reread it if there is anything unclear.

Epson SV Tools is shipped to our customers only after being subjected to the strictest quality controls, tests, and inspections to certify its compliance with our high performance standards. Please note that the basic performance of the product will not be exhibited if our Epson SV Tools is used outside of the usage conditions and product specifications described in the manuals.

This manual describes possible dangers and consequences that we can foresee. Be sure to comply with safety precautions on this manual to use our Epson SV Tools safety and correctly.

## TRADEMARKS

Microsoft, Windows, Windows logo, Visual Basic, and Visual C++ are either registered trademarks or trademarks of Microsoft Corporation in the United States and/or other countries.

Other brand and product names are trademarks or registered trademarks of the respective holders.

## TRADEMARK NOTIFICATION IN THIS MANUAL

Microsoft® Windows® 10 IoT Enterprise

Throughout this manual, Windows 10 and Windows refer to above respective operating systems.

## NOTICE

No part of this manual may be copied or reproduced without authorization.

The contents of this manual are subject to change without notice.

Please notify us if you should find any errors in this manual or if you have any comments regarding its contents.

## MANUFACTURER

**SEIKO EPSON CORPORATION**

## CONTACT INFORMATION

If you have any questions, please contact your supplier.



# BEFORE READING THIS MANUAL

This section describes what you should know before using the manual.

## SAFETY PRECAUTIONS

Please carefully read this manual and other related manuals before using this software.  
Keep this manual handy for easy access at all times and reread it if there is anything unclear.

## CONVENTIONS

|  |  |
|--|--|
| <br>WARNING | A warning indicates a potential for death or serious injury if mishandled without this indication.                                 |
| <br>CAUTION | If you ignore this indication and use it incorrectly, it is intended to cause injury to persons and to cause property damage only. |

## Regarding battery disposal

For European Union customers only



The crossed out wheeled bin label that can be found on your product indicates that this product and incorporated batteries should not be disposed of via the normal household waste stream. To prevent possible harm to the environment or human health please separate this product and its batteries from other waste streams to ensure that it can be recycled in an environmentally sound manner. For more details on available collection facilities please contact your local government office or the retailer where you purchased this product. Use of the chemical symbols Pb, Cd or Hg indicates if these metals are used in the battery.

This information only applies to customers in the European Union, according to DIRECTIVE 2006/66/EC OF THE EUROPEAN PARLIAMENT AND OF THE COUNCIL OF 6 September 2006 on batteries and accumulators and waste batteries and accumulators and repealing Directive 91/157/EEC and legislation transposing and implementing it into the various national legal systems.

For other countries, please contact your local government to investigate the possibility of recycling your product.

For Taiwanese customers only



Please separate used batteries from other waste streams to ensure that it can be recycled in an environmentally sound manner. For more details on available collection facilities please contact your local government office or the retailer where you purchased this product.

## Installation

|  |           |
|--|-----------|
| <b>1. Foreword</b>   | <b>3</b>  |
| 1.1 Overview of Epson Spectroscopic Vision Tools.....                              | 3         |
| 1.2 To Users of EPSON RC+ 7.0 Vision Guide .....                                   | 4         |
| Precautions When Using Spectroscopic Camera.....                                   | 4         |
| For Migrating to EPSON RC+ 7.0 Vision Guide .....                                  | 4         |
| Differences in Function between Epson SV Tools and EPSON RC+<br>Vision Guide ..... | 6         |
| <b>2. Manual and On-line Help</b>  | <b>7</b>  |
| <b>3. Safety</b>   | <b>8</b>  |
| 3.1 Conventions.....   | 8         |
| 3.2 Safety Precautions .....   | 8         |
| <b>4. Included Items and Optional Products</b>                                     | <b>9</b>  |
| <b>5. System Configuration</b>   | <b>10</b> |

## Hardware

|  |           |
|--|-----------|
| <b>1. Spectroscopic Vision Controller CV2-SV</b>                 | <b>13</b> |
| 1.1 Installation Precautions .....                               | 13        |
| 1.1.1 Part Names and Functions .....                             | 13        |
| 1.1.2 Spectroscopic Vision Controller LED Display.....           | 16        |
| 1.1.3 Spectroscopic Vision Controller Specifications .....       | 17        |
| 1.2 Wiring of Spectroscopic Vision Controller.....               | 19        |
| 1.2.1 Power Supply .....   | 19        |
| 1.2.2 24 VDC wiring .....  | 19        |
| 1.3 Maintenance .....  | 20        |
| 1.3.1 Internal Structure of Spectroscopic Vision Controller..... | 20        |
| 1.3.2 Fan Filter .....   | 21        |
| 1.3.3 LED/SW Board.....  | 21        |
| 1.3.4 PoE Board .....  | 22        |
| 1.3.5 CPU Board .....  | 23        |
| 1.3.6 Backup Battery.....  | 24        |
| 1.3.7 CFast.....   | 25        |
| 1.3.8 Memory .....   | 26        |

|   |           |
|---|-----------|
| 1.3.9 Chassis Fan .....   | 26        |
| <b>2. Spectroscopic Camera</b>  | <b>27</b> |
| 2.1 Spectroscopic Camera Cable Wiring .....   | 27        |
| 2.2 Part Names and Functions.....   | 28        |
| 2.3 Camera Installation and Storage .....   | 28        |
| 2.4 Spectroscopic Camera Specifications .....   | 30        |
| 2.5 Characteristics of Spectroscopic Camera.....  | 31        |
| 2.6 Individual Variability in Measurement Systems Including Spectroscopic<br>Camera ..... | 31        |
| <b>3. Camera Lens</b>   | <b>32</b> |
| 3.1 Megapixel Camera Lens .....   | 32        |
| 3.1.1 Lens Specification.....   | 32        |
| 3.1.2 Outline Drawing .....   | 32        |
| 3.2 Megapixel Camera Lens (HF).....   | 34        |
| 3.2.1 Lens Specification.....   | 34        |
| 3.2.2 Outline Drawing .....   | 34        |
| <b>4. Option Product Specifications</b>   | <b>36</b> |
| 4.1 A/C adaptor .....   | 36        |
| 4.1.1 Specifications.....   | 36        |
| 4.1.2 External dimensions .....   | 36        |
| 4.2 Camera Tripod Mount .....   | 37        |
| 4.2.1 Specifications.....   | 37        |
| 4.2.2 Dimensions .....  | 37        |
| 4.3 Software Adding Option .....  | 37        |
| <b>5. Maintenance Parts List</b>  | <b>38</b> |
| <b>6. Option</b>  | <b>38</b> |
| <b>1. Foreword</b>  | <b>41</b> |
| <b>2. OS Setup</b>  | <b>42</b> |
| 2.1 About OS.....   | 42        |

## Setup



|  |           |
|--|-----------|
| 2.2 OS Setup .....                                 | 43        |
| 2.3 Setting Time Zone .....                        | 47        |
| <b>3. Backup (Creating and Restoring an Image)</b> | <b>48</b> |
| 3.1 Creating an Image .....                        | 48        |
| 3.2 Restoring an Image .....                       | 52        |
| <b>4. Epson SV Tools Setup</b>                     | <b>57</b> |
| 4.1 Installation.....                              | 57        |
| 4.2 Uninstallation .....                           | 60        |
| <b>5. Software Option Key</b>                      | <b>61</b> |
| 5.1 Preparing for Epson SV Tools Option Key.....   | 61        |
| 5.2 Registering Epson SV Tools Option Key .....    | 63        |
| <b>6. Setting the Unified Write Filter</b>         | <b>65</b> |

## Software

|  |           |
|--|-----------|
| <b>1. Starting the Software and Spectroscopic Camera Setup Procedure</b> | <b>69</b> |
| 1.1 Turn the Power On .....  | 69        |
| 1.2 Starting Epson SV Tools .....  | 69        |
| 1.3 Spectroscopic Camera Setup Procedure.....                            | 70        |
| <b>2. Epson SV Tools GUI</b>   | <b>71</b> |
| 2.1 Summary .....  | 71        |
| 2.2 Configuration .....  | 72        |
| 2.3 Preview .....  | 73        |
| 2.4 Measurement.....   | 74        |
| 2.5 Status Bar .....   | 75        |
| 2.6 Help Button .....  | 75        |
| 2.7 Data Browser .....   | 76        |
| 2.8 Data Analysis_Color / Spectrum Information .....                     | 77        |
| 2.9 Data Analysis_Color Inspection .....                                 | 78        |
| 2.10 Data Analysis_Color Difference Distribution .....                   | 79        |
| 2.11 Data Analysis_Color Unevenness Inspection .....                     | 80        |
| 2.12 Data Analysis_Spectrum Distinction .....                            | 81        |

|   |           |
|---|-----------|
| 2.13 Data Analysis_Fabric Inspection.....                     | 82        |
| <b>3. Preview Image Settings</b>                              | <b>84</b> |
| 3.1 Color Display .....                                       | 84        |
| 3.2 Displaying a Spectral Image and Selecting Wavelength..... | 85        |
| 3.3 Exposure Time Settings .....                              | 86        |
| 3.4 Gain Settings.....  | 87        |
| 3.5 Capturing Preview Images .....                            | 88        |
| <b>4. Measurement</b>   | <b>89</b> |
| 4.1 Project Settings .....                                    | 89        |
| 4.2 Measurement .....   | 89        |
| 4.2.1 Measurement for White Balance .....                     | 90        |
| 4.2.2 Measurement for Spectrum .....                          | 92        |
| <b>5. Data Browser</b>  | <b>94</b> |
| 5.1 Loading Data .....  | 94        |
| 5.2 Renaming Data .....                                       | 95        |
| 5.3 Deleting Data.....  | 95        |
| 5.4 Deleting Projects .....                                   | 96        |
| <b>6. Search Window</b>                                       | <b>97</b> |
| <b>7. Data Analysis Functions</b>                             | <b>98</b> |
| 7.1 Color / Spectrum Information .....                        | 98        |
| 7.1.1 Usage.....  | 98        |
| 7.1.2 Chromaticity Graph .....                                | 99        |
| 7.1.3 Save Analytical Data.....                               | 99        |
| 7.2 Color Inspection .....                                    | 100       |
| 7.2.1 Data Registration .....                                 | 100       |
| 7.2.2 Delete Registered Data .....                            | 102       |
| 7.2.3 Color Inspection .....                                  | 102       |
| 7.2.4 Save Analytical Data.....                               | 104       |
| 7.3 Color Difference Distribution .....                       | 104       |
| 7.3.1 Reference Lab Configuration.....                        | 104       |
| 7.3.2 Color Difference Heatmap Configuration .....            | 105       |
| 7.3.3 Binarized Image Configuration .....                     | 106       |

|  |     |
|--|-----|
| 7.3.4 Save Analytical Data.....                          | 107 |
| 7.4 Color Unevenness Inspection .....                    | 107 |
| 7.4.1 Usage.....   | 107 |
| 7.4.2 Color Unevenness Waveform Graph.....               | 109 |
| 7.4.3 Saving Data.....                                   | 110 |
| 7.5 Spectrum Distinction.....                            | 110 |
| 7.5.1 Data Registration (New).....                       | 110 |
| 7.5.2 Data Registration (Loading Data) .....             | 112 |
| 7.5.3 Hiding Registered Data.....                        | 113 |
| 7.5.4 Delete Registered Data.....                        | 114 |
| 7.5.5 Spectrum Distinction Image Threshold Settings..... | 114 |
| 7.5.6 Saving Configuration Data .....                    | 115 |
| 7.6 Fabric Inspection .....                              | 115 |
| 7.6.1 Data Registration .....                            | 116 |
| 7.6.2 Delete Registered Data.....                        | 117 |
| 7.6.3 Color Inspection .....                             | 118 |
| 7.6.4 Save Analytical Data.....                          | 119 |

## **8. Backing Up Measurement and Registered Data 120**

## **9. Tutorial 121**

|  |     |
|--|-----|
| 9.1 Before Starting This Tutorial.....                               | 121 |
| 9.2 Color Patch Color/Spectrum Information and Color Inspection..... | 122 |
| 9.2.1 Purpose and Measurement Configuration.....                     | 122 |
| 9.2.2 Start Epson SV Tools and Create a New Project.....             | 126 |
| 9.2.3 Measurement for White Balance .....                            | 126 |
| 9.2.4 Measurement for Spectrum of Color Patches .....                | 128 |
| 9.2.5 Color / Spectrum Information .....                             | 130 |
| 9.2.6 Color Inspection of Color Patches .....                        | 131 |
| 9.2.7 Per Pixel Color Inspection of Color Patches.....               | 135 |
| 9.3 Color Unevenness Inspection .....                                | 139 |
| 9.3.1 Purpose and Measurement Configuration.....                     | 139 |
| 9.3.2 Start Epson SV Tools and Create a New Project.....             | 141 |
| 9.3.3 Measurement for White Balance .....                            | 141 |
| 9.3.4 Measurement for Spectrum .....                                 | 141 |
| 9.3.5 Color Unevenness Inspection.....                               | 142 |
| 9.4 Spectrum Distinction of Lace Fabric .....                        | 144 |
| 9.4.1 Purpose and Measurement Configuration.....                     | 144 |

|  |     |
|--|-----|
| 9.4.2 Start Epson SV Tools and Create a New Project..... | 146 |
| 9.4.3 Measurement for White Balance .....                | 146 |
| 9.4.4 Measurement for Spectrum .....                     | 146 |
| 9.4.5 Spectrum Distinction .....                         | 146 |
| 9.5 Fabric Color Inspection .....                        | 150 |
| 9.5.1 Purpose and Measurement Configuration.....         | 150 |
| 9.5.2 Start Epson SV Tools and Create a New Project..... | 152 |
| 9.5.3 Measurement for White Balance .....                | 152 |
| 9.5.4 Measurement for Spectrum .....                     | 152 |
| 9.5.5 Fabric Color Inspection.....                       | 152 |

|                            |            |
|----------------------------|------------|
| <b>10. Troubleshooting</b> | <b>156</b> |
|----------------------------|------------|

|  |     |
|--|-----|
| 10.1 Error Messages .....  | 156 |
| 10.2 The Spectroscopic Vision Controller Does Not Recognize the Spectroscopic Camera ..... | 158 |

|                       |            |
|-----------------------|------------|
| <b>11. Trial Mode</b> | <b>160</b> |
|-----------------------|------------|

|  |     |
|--|-----|
| 11.1 Overview .....                        | 160 |
| 11.2 Connecting Spectroscopic Camera ..... | 160 |
| 11.3 Discarding Registered Data .....      | 160 |

## Appendix

|  |            |
|--|------------|
| <b>Appendix A: Various Approximate Formulas for Lens</b> | <b>163</b> |
|--|------------|

|                                    |            |
|------------------------------------|------------|
| <b>Appendix B: Sample Projects</b> | <b>165</b> |
|------------------------------------|------------|

|   |            |
|---|------------|
| <b>Appendix C: Open Source Software License Agreement</b> | <b>166</b> |
|---|------------|

|                          |            |
|--------------------------|------------|
| <b>Appendix D: Other</b> | <b>167</b> |
|--------------------------|------------|

# Installation

The following chapters contain information to be known before using Spectroscopic Vision System. Please be sure to read these chapters.



# 1. Foreword

## 1.1 Overview of Epson Spectroscopic Vision Tools

Epson Spectroscopic Vision Tools (hereinafter “Epson SV Tools”) is programming-less software specialized in spectroscopic functions that enables from spectroscopic measurement to color analysis and inspection.

It is easy to judge whether color inspection is possible, quantify a reference color, and set a judgment threshold with Spectroscopic Camera.

The features of Epson SVTools are as follows:

- Previewing a spectroscopic or color image
- Spectroscopic measurement function (acquisition of 16 spectroscopic images at intervals of 20 nm from 400 nm to 700 nm)
- Acquisition and application of white balance data
- Data analysis: Color and spectrum information  
(A function to compare color information with two specified spectrum)
- Data analysis: Color inspection  
(A function to register the master of the color to be inspected, calculate the color difference for the registered color, and judge PASS or FAIL from threshold value)
- Data analysis: Distribution of color difference  
(A function to calculate color difference by pixel for the specified reference color, check color unevenness by micro, and inspect by pixel using the threshold value of the color difference)
- Data analysis: Color unevenness inspection  
(A function to divide a specified area into matrix and inspect color unevenness by macro from the average color information of each divided block)
- Data analysis: Spectrum discrimination  
(A function to register a spectrum shape to be detected, pick up an object similar to the spectrum shape of each pixel of the measurement data for the registered data, fill it with a color, and inspect whether there is the registered data)
- Data analysis: Fabrics inspection  
(A function to remove unnecessary background such as shadow due to weaving of fiber and perform color inspection)

## 1.2 To Users of EPSON RC+ 7.0 Vision Guide

### Precautions When Using Spectroscopic Camera

- EPSON RC+ 7.0 Vision Guide and Epson SV Tools cannot be connected to Spectroscopic Camera at the same time
- Pre-measured data can be analyzed regardless of whether Spectroscopic Camera is being used.
- When Spectroscopic Camera is being used on Epson SV Tools, you cannot do camera setting on EPSON RC+ When the camera is being used with EPSON RC+, you cannot use Spectroscopic Camera even after starting Epson SV Tools.

### For Migrating to EPSON RC+ 7.0 Vision Guide

In order to use EPSON RC+ 7.0 Vision Guide, customers need to learn robot language, robot vision, spectroscopic parameters, etc. and create inspection software. For customers who have no programming experience and only need the spectroscopic measurement function, or who require to do the proof of concept by spectroscopic inspection in a timely manner, the settings can be complexed.

Epson SV Tools is programming-less software that enables spectroscopic measurement and color analysis. Furthermore, it is easy to judge whether color inspection is possible, quantify a reference color, and set a judgment threshold on Spectroscopic Camera.

The reference colors and judgment thresholds set in Epson SV Tools can be used in EPSON RC+ 7.0 Vision Guide.



## Inspection

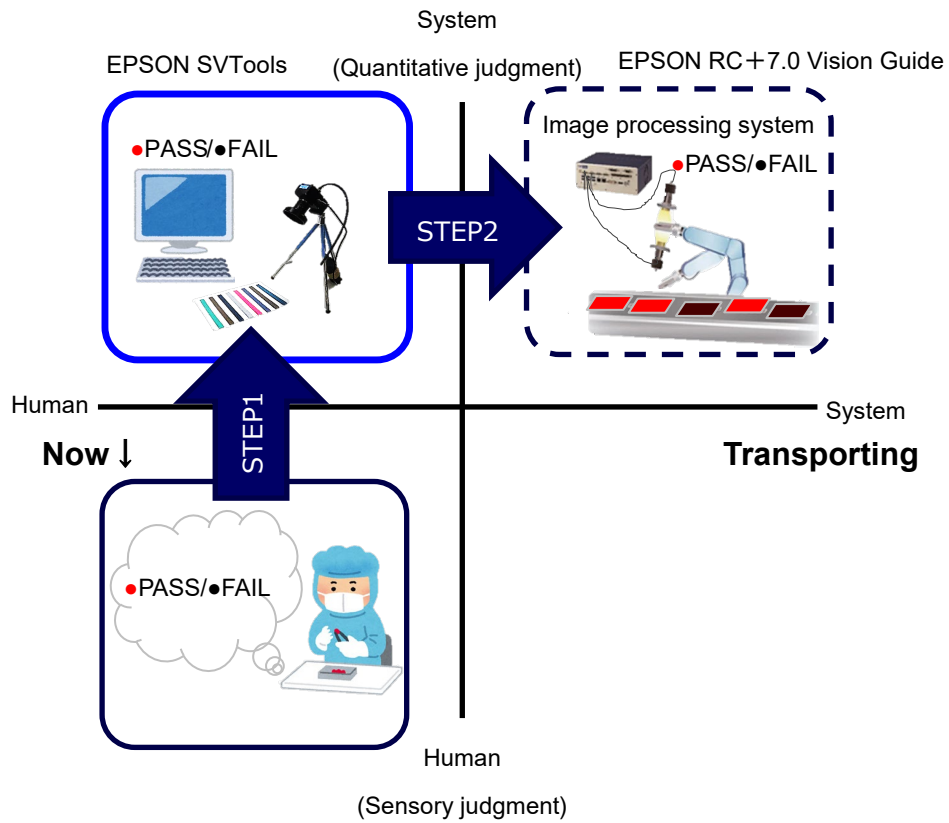

## Programming

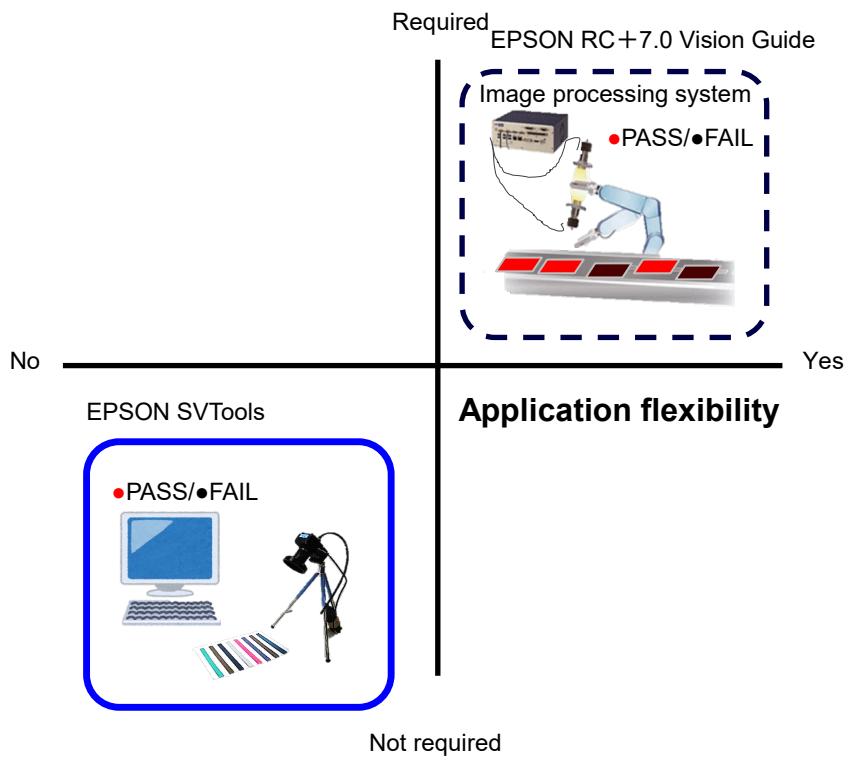

## Differences in Function between Epson SV Tools and EPSON RC+ Vision Guide

Epson SV Tools is programming-less software specialized in color inspection by spectroscopic function. The color inspections by the average color information in the search window or by pixel are enabled.

On the other hand, EPSON RC+ 7.0 Vision Guide is software that assumes in-line automatic inspection which enables color inspection, image processing, and communication with external devices by the average color information in the search window.

Functions for each software are as the table below.

| Function                       |   | EPSON RC+ 7.0 Vision Guide | Epson SVTools |
|--------------------------------|---|----------------------------|---------------|
| Spectroscopic function         | Spectroscopic measurement   | ✓                          | ✓             |
|                                | Chart representation  | ✓                          | ✓             |
|                                | Color inspection (area-average)                                     | ✓                          | ✓             |
|                                | Representation and output of color difference distribution by pixel | ✓                          | ✓             |
|                                | Color unevenness inspection   | ✓                          | ✓             |
|                                | Judgment by spectrum (area-average)                                 |                            | ✓             |
|                                | Discrimination by spectrum (by pixel)                               |                            | ✓             |
|                                | Fabrics inspection  |                            | ✓             |
| Image processing               | Filtering   | ✓                          |               |
|                                | Recognition of position and shape                                   | ✓                          |               |
|                                | Measurement   | ✓                          |               |
| Interface                      | Socket communication  | ✓                          |               |
| Data output                    | Area-average  | ✓                          | ✓             |
|                                | By pixel  |                            | ✓             |
|                                | Image   |                            | ✓             |
| Detection area                 | Specified area  | ✓                          | ✓             |
|                                | Entire (by 1-pixel)   |                            | ✓             |
| Interlocking with other camera | Monochrome camera   | ✓                          |               |
|                                | Color camera  | ✓                          |               |

## 2. Manual and On-line Help

This section provides general information on this manual.

### Installation

This section describes online help, safety, included items and optional products, and system configuration.

### Hardware

#### Spectroscopic Vision Controller

This section describes installation, electrical specification, and maintenance.

#### Spectroscopic Camera

This section describes the spectroscopic camera and camera lens.

#### Optional product specification, Maintenance parts

This section describes various optional products and maintenance parts.

### Setup

This section describes setting up the operating system and application software.

This section describes software configuration and integrated write filters.

### Software

This section describes usage of Spectroscopic Camera and function and operation of Epson SV Tools.

#### Tutorial

This section describes how to perform a color test by using Spectroscopic Camera.



This section describes other topics include troubleshooting, lenses, and samples.

## 3. Safety



Please read this manual before using the Spectroscopic Vision System.  
 Keep this manual handy for easy access at all times and reread it when you find anything unclear.

### 3.1 Conventions

Important safety considerations are indicated throughout the manual by the following symbols. Be sure to read the descriptions shown with each symbol.

|   |  |
|---|--|
| <br>WARNING  | This symbol indicates that a danger of possible serious injury or death exists if the associated instructions are not followed properly.                                       |
| <br>WARNING  | This symbol indicates that a danger of possible harm to people caused by electric shock exists if the associated instructions are not followed properly.                       |
| <br>CAUTION | This symbol indicates that a danger of possible harm to people or physical damage to equipment and facilities exists if the associated instructions are not followed properly. |

### 3.2 Safety Precautions

|  |  |
|--|--|
| <br>WARNING | <ul style="list-style-type: none"> <li>■ The product must be used within the conditions described in this manual.<br/>                     Using the product in an environment that exceeds the specified environmental conditions may not only shorten the life cycle of the product but may also cause serious safety problems.</li> </ul> |
| <br>CAUTION | <ul style="list-style-type: none"> <li>■ Purchase cameras and camera cables from our suppliers.<br/>                     Note that cameras and camera cables of other manufacturers are not included in the warranty.</li> </ul>   |
| <br>CAUTION | <ul style="list-style-type: none"> <li>■ This product is designed for industrial environments. Do not use the product except in industrial environments.</li> </ul>  |

## 4. Included Items and Optional Products

### Included Items

- Spectroscopic Vision Controller (1 controller)
- Power source connector (1 connector)
- Rubber foot (4 pcs)
- Mounting bracket (1 set)
- Connector covers (2 pcs)
- Spectroscopic Camera (1 camera)
- Camera protective cap (1 cap)
- USB 3.0 Spectroscopic Camera Cable (3m)
- USB 2.0 Spectroscopic Camera Cable (3m)

### Main optional products

- A/C adaptor
- Camera tripod mount
- Megapixel camera lens (8mm, 12mm, 16mm, 25mm, 50mm)
- Megapixel lens (HF) (8mm, 12mm, 16mm, 25mm, 35mm)

## 5. System Configuration

The illustration below shows the system configuration using the Spectroscopic Vision System.

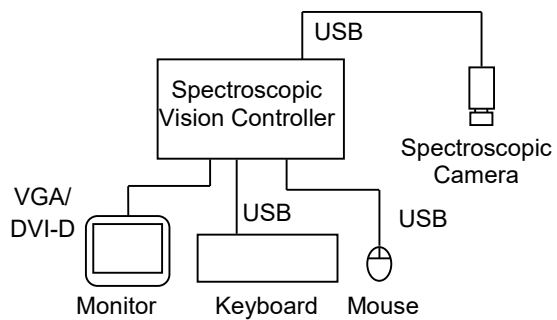

# Hardware





# 1. Spectroscopic Vision Controller CV2-SV

## 1.1 Installation Precautions

### 1.1.1 Part Names and Functions

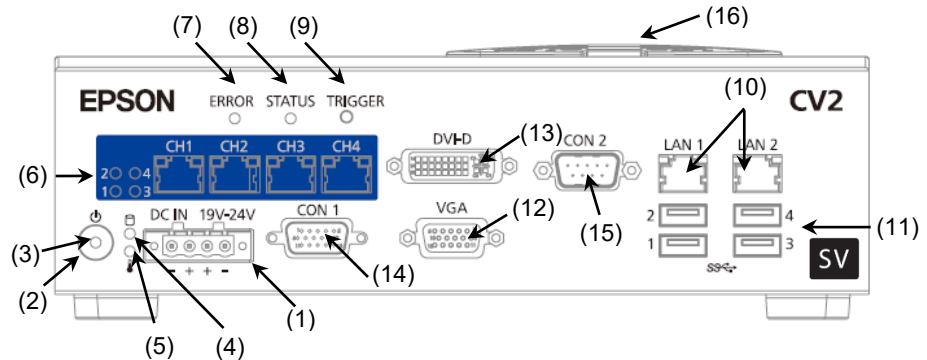

| No | Name                    | Function   |
|----|-------------------------|--|
| 1  | 24V Input Connector     | This connector is to supply 24V from 24V power source.   |
| 2  | Power Switch            | Spectroscopic Vision Controller automatically starts up when 24V power source is applied. However, it does not turn ON automatically when the battery voltage is low. In this case, you can turn ON the Spectroscopic Vision Controller by pressing this button.<br>When the power is on, press to turn the power off. |
| 3  | Power LED               | Refer to <i>Hardware "1.1.2 Spectroscopic Vision Controller LED Display"</i> .   |
| 4  | CFast Access LED        |  |
| 5  | Temperature Warning LED |  |
| 6  | PoE LED (1 to 4)        |  |
|    | PoE Connector (4 ports) |  |
| 7  | ERROR LED               | Refer to <i>Hardware "1.1.2 Spectroscopic Vision Controller LED Display"</i> .   |
| 8  | STATUS LED              |  |
| 9  | TRIGGER Switch          | Not available.   |
| 10 | LAN Connector (2 ports) | Connectors for network hub and Robot Controllers   |
| 11 | USB Connector (4 ports) | Connectors for camera, keyboard, and mouse.  |
| 12 | VGA Connector           | A connector for the analog monitor.<br>Use a monitor which resolution is 1280 × 1024 or higher.  |

| No | Name            | Function  |
|----|-----------------|---|
| 13 | DVI-D Connector | A connector for the monitor which is compatible with DVI-D<br>Use a monitor which resolution is 1280 × 1024 or higher.<br>The monitors which only supports DVI-I cannot be connected to this connector. |
| 14 | CON1            | Not available.<br>Install the attached connector cover.   |
| 15 | CON2            | Serial Port<br>Install the attached connector cover when not in use.  |
| 16 | Fan Filter      | A filter for the intake air fan.  |

**Installation environment (Spectroscopic Vision Controller/Camera)**

In order to optimize the product’s performance for safety, Spectroscopic Vision Controller and the camera(s) must be placed in an environment that satisfies the following conditions. Place the Spectroscopic Vision Controller and camera in a location that meet the following conditions:

- Install indoors only and place in a well-ventilated area.
- Keep away from direct sunlight.
- Keep away from radiation heat.
- Keep away from dust, oily mist, oil, salinity, metal powder or other contaminants.
- Keep away from water.
- Keep away from shocks or vibrations.
- Keep away from sources of electronic noise.
- Prevent the occurrence of strong electric or magnetic field.

**Mounting Direction (Spectroscopic Vision Controller)**

The Spectroscopic Vision Controller can be installed both horizontally and vertically (using the fixing brackets).

|   |   |
|---|---|
| <br><b>CAUTION</b> | <ul style="list-style-type: none"> <li>■ For fixing the Spectroscopic Vision Controller, use the attached fixing brackets and screws. Internal board may get damages if fixing the Spectroscopic Vision Controller with the screws other than the attached ones.</li> </ul> |
|---|---|

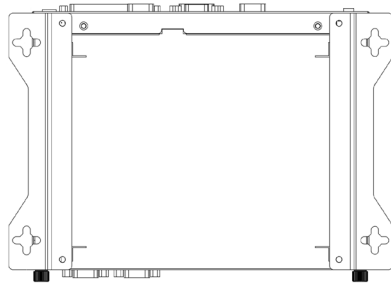

Brackets installed on the bottom

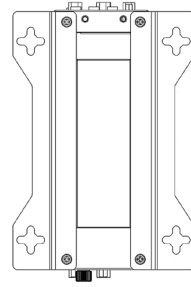

Brackets installed on the side

NOTE



Allow at least 50 mm from the wall to prevent blocking the fan filter and the air holes.  
When installing the Spectroscopic Vision Controller vertically, install it so as not to block ventilation of the air holes on the side where the fixing brackets are mounted.  
Do not install the product near instruments with huge heating value.

### 1.1.2 Spectroscopic Vision Controller LED Display

Each LED of Spectroscopic Vision Controller indicates conditions as follows.

#### Power LED

|                                 |        |
|---------------------------------|--------|
| Power On                        | Green  |
| Power off (current applied)     | Orange |
| Power off (current not applied) | OFF    |

#### CFast access LED

|           |        |
|-----------|--------|
| Access    | Orange |
| No Access | OFF    |

#### Temperature warning LED

|  |     |
|--|-----|
| Warning (CPU temp.: exceeding 105 °C)    | Red |
| No warning (CPU temp.: less than 105 °C) | OFF |

#### PoE LED

|                    |     |
|--------------------|-----|
| Power supplied     | Red |
| Power not supplied | OFF |

#### ERROR/STATUS LED

| State                      | ERROR LED (Red) | STATUS LED (Green) |
|----------------------------|-----------------|--------------------|
| Power ON                   | ON              | ON                 |
| After normal startup of OS | OFF             | ON                 |
| Power OFF                  | OFF             | OFF                |

1.1.3 Spectroscopic Vision Controller Specifications

| Item                      | Specification  |
|---------------------------|--|
| Number of Cameras         | 1 Spectroscopic Vision Camera (Only our cameras and cables can be used.) |
| Power Source Voltage      | 19 to 24 VDC   |
| Rated Electric Current    | 11.57 A (at 19 VDC) to 9.16 A. (at 24VDC)                                |
| Rated Ambient Temperature | 5 to 40 °C   |
| Rated Relative Humidity   | 20 to 80% (with no condensation)   |
| Weight                    | 2.1 kg   |

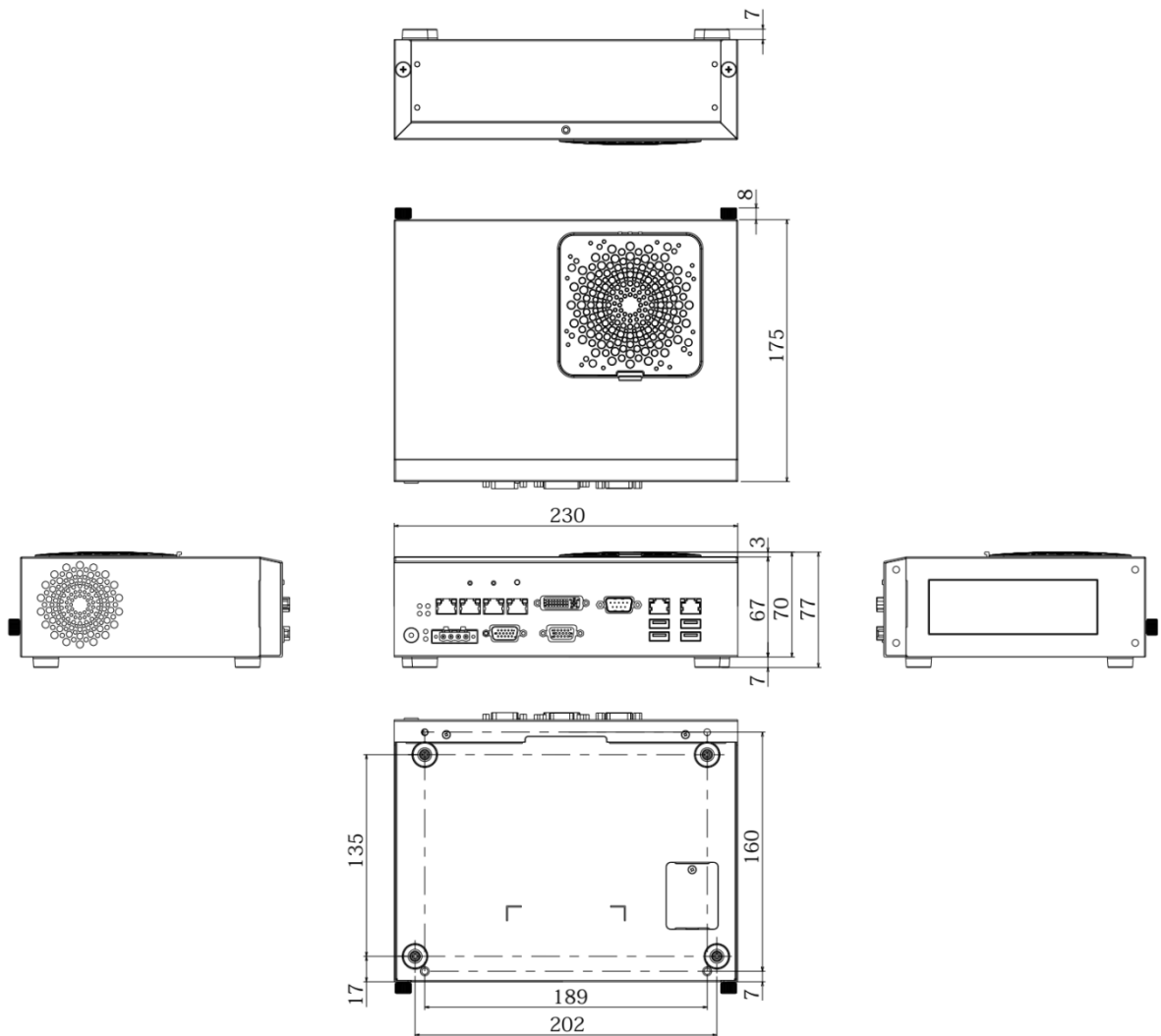

Brackets installed on the bottom

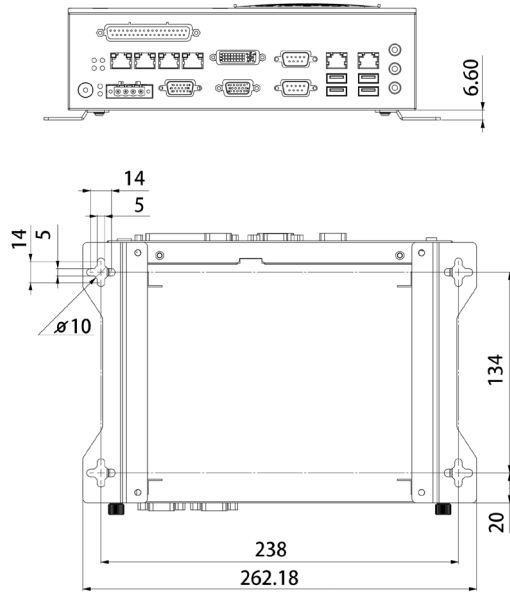
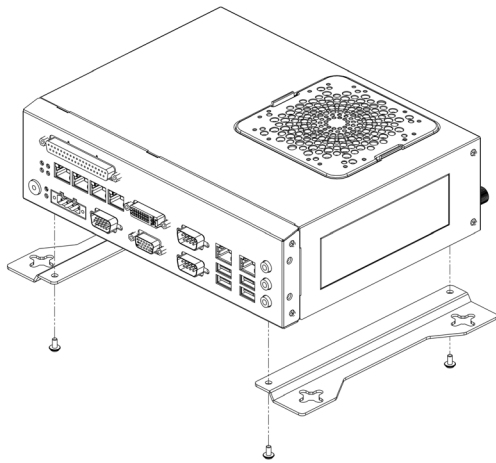

Brackets installed on the side

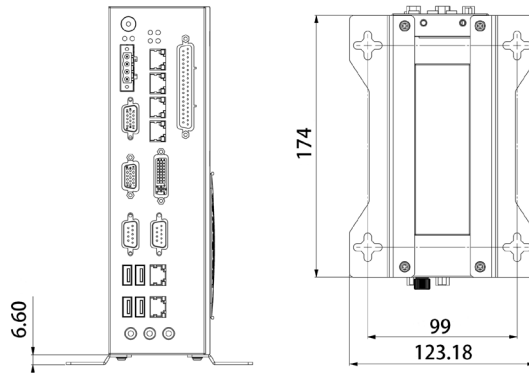
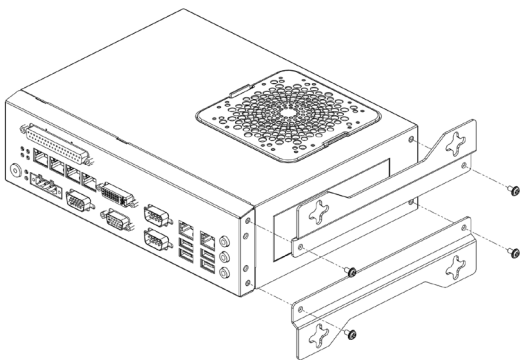

## 1.2 Wiring of Spectroscopic Vision Controller

For details for wiring camera, refer to *Hardware 2. Camera*.

### 1.2.1 Power Supply

Ensure that the power source for Spectroscopic Vision Controller satisfies the following specifications.

- Voltage: 19 VDC (11.57 A or less) to 24VDC (9.16 A or less)
- Satisfies the EMC standards in an industrial setting
- Have a reinforced insulation against the AC power source
- Have an overcurrent protection circuit build-in

It is recommended to use the specialized power source for Spectroscopic Vision Controller. When power source is shared with other equipment, ensure not to use the power source connected to the equipments generating electronic noise or take adequate measures against electronic noise.

### 1.2.2 24 VDC wiring

When using an adapter other than the optional A/C adapter, refer to the following and wire the 24VDC power source to the connector.

| Indication on Spectroscopic Vision Controller | Description of signal    |
|---|--------------------------|
| -   | 24 V power source ground |
| +   | 24 V power source input  |
| +   | 24 V power source input  |
| -   | 24 V power source ground |

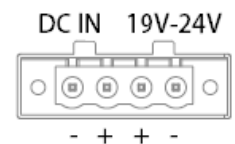

Appropriate Wire Diameter :AWG14 to AWG24

|   |   |
|---|---|
| <br><b>CAUTION</b> | <ul style="list-style-type: none"> <li>■ Be sure to turn OFF the product when wiring the power source. Make sure that wiring and voltage are correct before turning ON the product.</li> <li>■ Use as thick and short a wire as possible for wiring 24VDC power source.</li> <li>■ Keep the 24VDC power source cable away from peripheral noise sources as possible.</li> <li>■ Do not insert and remove the connector while applying current to the 24VDC connector.<br/>ON/OFF switch must be installed at AC side of the 24VDC power source. Inserting and removing the connector while applying current to the 24V connector or turning ON/OFF at DC 24V side may cause fusing inside Spectroscopic Vision Controller.</li> </ul> |
|---|---|

When using optional A/C adapter, insert the connector into the DC in and secure it with the screw.

|   |  |
|---|--|
| <br><b>CAUTION</b> | <ul style="list-style-type: none"> <li>■ Do not insert and remove the connector while applying current to the 24VDC connector.<br/>Always unplug the AC side before turning the power ON/OFF.</li> </ul> |
|---|--|

### 1.3 Maintenance

|  |  |
|--|--|
| <br>CAUTION | <ul style="list-style-type: none"><li>■ Always unplug the power plug while the cover of the Spectroscopic Vision Controller is open.</li><li>■ There is a sharp edge in the Spectroscopic Vision Controller. Be careful of injury and protect your hands with gloves.</li><li>■ Be aware of the following point.<ul style="list-style-type: none"><li>Destroying the part</li><li>Leaving screws in the Spectroscopic Vision Controller</li><li>Static electricity</li><li>Connector direction</li></ul></li></ul> |
|--|--|

#### 1.3.1 Internal Structure of Spectroscopic Vision Controller

How to remove the top cover

- (1) Remove the screw 1 on the Spectroscopic Vision Controller rear face.
- (2) Loosen the screw 2 on the Spectroscopic Vision Controller rear face.
- (3) Slide the top cover toward the rear side while slightly lifting it up.

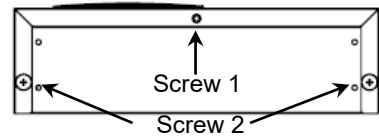

Internal Structure of Spectroscopic Vision Controller

Spectroscopic Vision Controller Top side

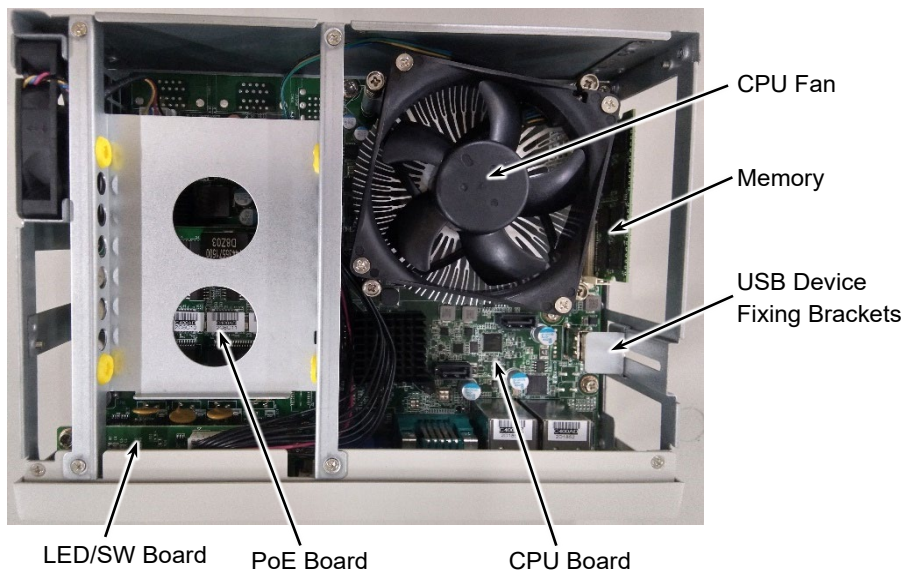



Left side when facing the front side of Spectroscopic Vision Controller

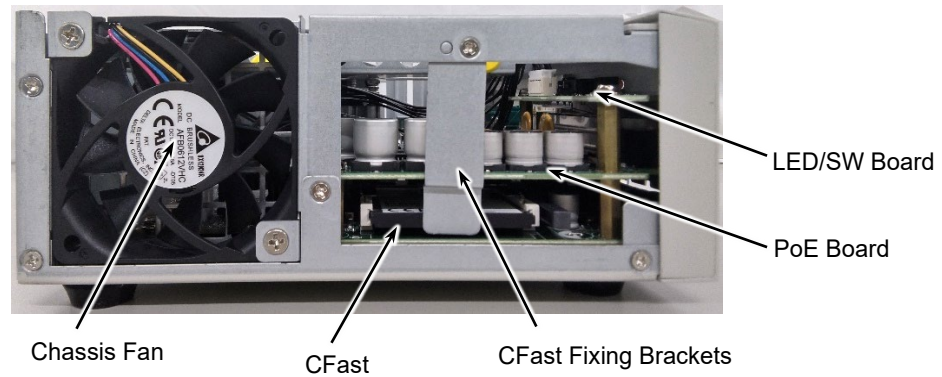

### 1.3.2 Fan Filter

Inspect the fan filter periodically and clean it when needed. The temperature inside the Spectroscopic Vision Controller may get too high and it may not operate properly if the filter is not kept clean.

- (1) Turn OFF the power supply for Spectroscopic Vision Controller.  
Be sure to turn OFF at the AC side of the 24VDC power source.
- (2) Remove the filter on the top face of Spectroscopic Vision Controller.
- (3) Clean the filter using a vacuum cleaner.
- (4) Install the filter.

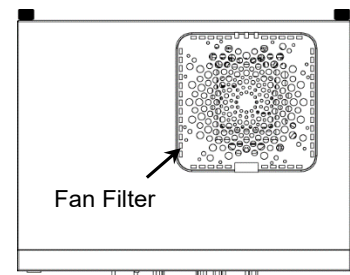

### 1.3.3 LED/SW Board

To replace the LED/SW board, follow the steps below.

- (1) Remove the top cover.  
(Refer to *Hardware 1.3.1 Internal Structure of Spectroscopic Vision Controller*)
- (2) Remove four screws fixing the internal brackets.
- (3) Remove four screws fixing the front cover. (2 screws on the top face, 2 screws on the bottom face.)



- (4) Remove the fitting screws on the both ends of following connectors using a nut driver.  
VGA / DVI-D / CON1 / CON2
- (5) Remove the front cover.

- (6) Remove the cables connected to the LED/SW board.
- (7) Remove two screws fixing the LED/SW board and remove the board.
- (8) Set the new LED/SW board and fix it in the reverse order to removal.

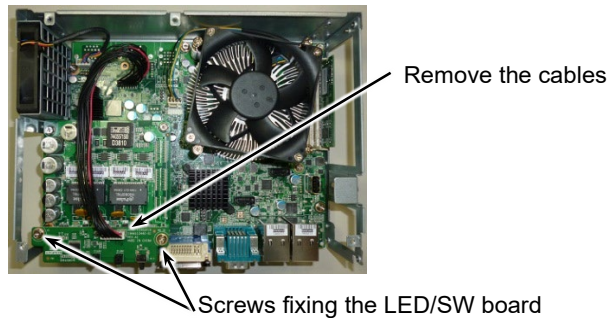

### 1.3.4 PoE Board

To replace the PoE board, follow the steps below.

- (1) Follow the steps (1) through (7) in 1.3.3 LED/SW Board.
- (2) Remove two spacers and two screws fixing the PoE board.

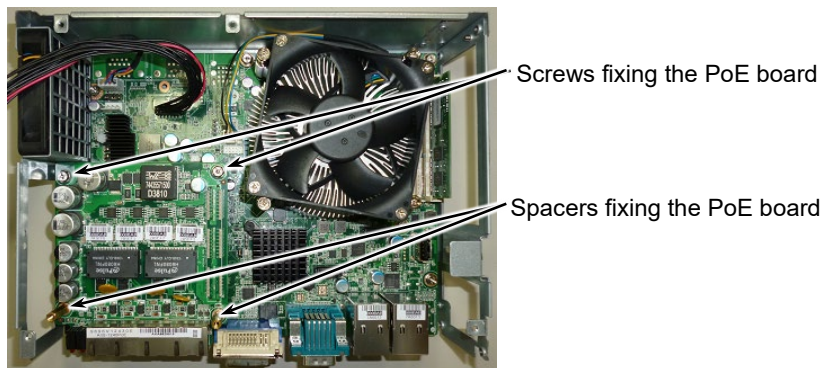

- (3) Slide the PoE board up straight and slowly.  
The back side of the PoE board is connected to the CPU board by connectors. When removing the PoE board, be careful not to apply excessive force.
- (4) When removing the PoE board, the spacers on the CPU board may get loose. In this case, tighten the spacers again.
- (5) Install the new PoE board.  
Be careful not to apply excessive force to the connectors for the CPU board.
- (6) Fix the board in the reverse order to removal.

### 1.3.5 CPU Board

To replace the CPU board, refer to the steps below.

- (1) Follow the steps (1) through (3) in 1.3.4 PoE Board.
- (2) Remove the chassis fan cable and the LED/SW board connection cable on the CPU board.
- (3) Remove the Cfast fixing bracket and USB device fixing bracket.
- (4) Remove four spacers and five screws fixing the CPU board.

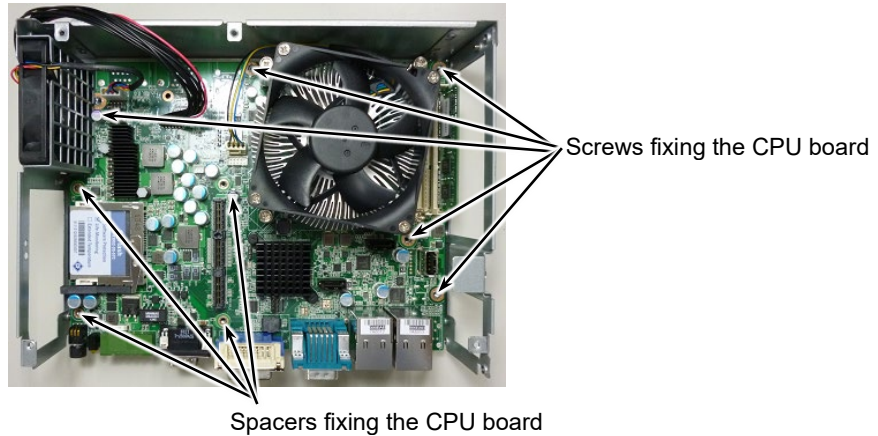

- (5) Remove the CPU board.  
Lift the board carefully not to hitch to the chassis plate.
- (6) Remove the CFast, memory and USB dongle on the removed CPU board.
- (7) Install the CFast, memory and USB dongle to the new CPU board.
- (8) Install the new CPU board to the bottom of the chassis while aligning to the screw holes.
- (9) Fix the board in the reverse order to removal.

Be careful of the direction of the LED/SW cables.

(The red cable of the LED/SW cables must be on the right side when facing the front face of the Spectroscopic Vision Controller.)

### 1.3.6 Backup Battery



- Handle lithium batteries with care. If handled as described below, it can cause heat generation, leakage, explosion, fire, etc., and is extremely dangerous. It can also cause a safety hazard.
  - Charging
  - Disassembly
  - Reverse loading
  - Putting in fire
  - Forced discharge
  - Pressure deformation
  - Short (+pole, -pole)
  - Heating (85 °C or higher)
  - Soldering (direct battery terminal soldering)
- Use the maintenance parts provided by the manufacturer for the battery. (Refer to *Maintenance "5. Maintenance Parts List"*)
- When disposing of the battery, consult with the professional disposal services or comply with the local regulation. Spent battery or not, make sure the battery terminal is insulated. If the terminal contacts with the other metals, it may short and result in heat generation, leakage, explosion, or inflammation.

To replace the battery, follow the steps below.

- (1) Remove a screw of the battery replacement cover on the bottom and remove the cover.
- (2) Insert a small flat-head screwdriver to the groove on the battery holder and lift up the battery slowly.

The battery may jump by the spring of the battery holder. Be careful.

- (3) Set the new battery while the + side facing the front.
- (4) Fix the cover.

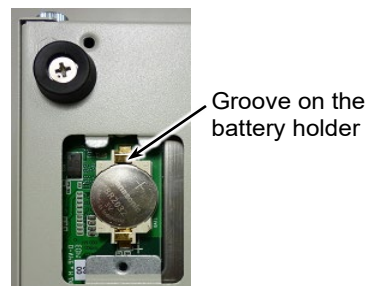
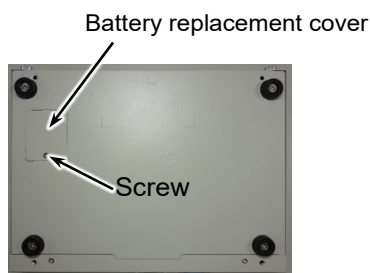

### 1.3.7 CFast

To replace the CFast, follow the steps below.

- (1) Remove the top cover.  
Refer to *Hardware 1.3.1 Internal Structure of Spectroscopic Vision Controller*
- (2) Remove the Cfast retainer.
- (3) Press the eject button to remove the CFast.
- (4) Attach a new CFast.



- (5) Install the CFast retaining bracket.
- (6) Install the top cover.

### 1.3.8 Memory

To replace the memory, follow the steps below.

- (1) Remove the top cover.  
Refer to *Hardware 1.3.1 Internal Structure of Spectroscopic Vision Controller*
- (2) Remove the memory while gently opening the clips on each of the memory socket outside.
- (3) Remove the memory from the memory socket.
- (4) Insert the new memory to the memory slot obliquely. Fix it with the tabs on the memory socket by pushing the memory lightly toward the CPU.
- (5) Install the top cover.



### 1.3.9 Chassis Fan

To replace the chassis fan, follow the steps below.

- (1) Remove the top cover.  
Refer to *Hardware 1.3.1 Internal Structure of Spectroscopic Vision Controller*
- (2) Remove four screws of the internal brackets and remove the brackets.
- (3) Remove the chassis fan cables connected to the CPU board.
- (4) Remove two screws fixing the chassis fan.
- (5) Slide up the chassis fan and remove it.
- (6) Install the new fan and fix it in the reverse order to removal.

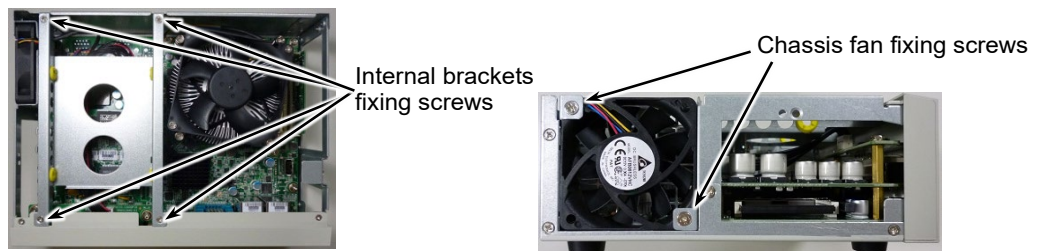

## 2. Spectroscopic Camera

### 2.1 Spectroscopic Camera Cable Wiring

When wiring the Spectroscopic Camera cables, be sure to satisfy the following:

- Do not bend the cable within 100 mm from the camera connector.
- Bend radius must be 60 mm or longer.
- Install the cable so as not to apply load on the connector.
- Put the Spectroscopic Camera as far from the surrounding noise as possible.

Bend radius:

60 mm or longer

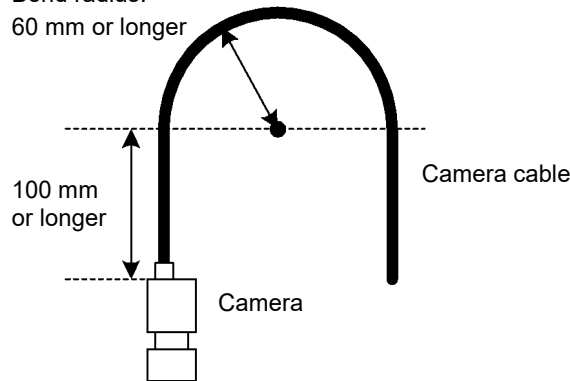

The Spectroscopic Camera is connected to the front panel of the Spectroscopic Vision Controller with the included Spectroscopic Camera cable.

Connect the Spectroscopic Camera Cable to one of the two USB receptacles on the front panel. Connect the Spectroscopic Camera Cable to one of the two connectors USB1 through 4 on the Spectroscopic Vision Controller.

- Only one Spectroscopic Camera can be connected.
- Do not use USB hubs or USB repeaters.
- Install the cable not to apply load on the USB connector.
- Keep the Spectroscopic Camera Cable. as far away from surrounding noise source as possible.

Note





- Ensure that the following cables are not bound together when installing the camera. Distortion of an image may occur due to the noise.
  - Cable for connecting the camera head and the body
  - Cable that could be noise sources such as the power cable
- Winding or bundling excess cables can be susceptible to noise.

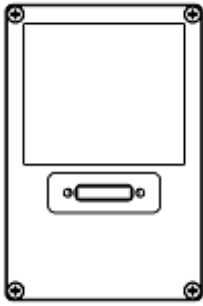

- Do not use the USB hub, USB repeater or USB extender cable. It may causes problem on your system.

## 2.2 Part Names and Functions

| Image   | Name              | Function  |
|---|-------------------|---|
|  | USB 3.0 connector | Connect the Spectroscopic Camera to the Spectroscopic Vision Controller |
|  | USB 2.0 connector | Connect the Spectroscopic Camera to the Spectroscopic Vision Controller |

## 2.3 Camera Installation and Storage

When you install the Spectroscopic Camera on the instrument, use three M3 screws to secure it to the instrument on either side of the two sides of the Spectroscopic Camera. The length of the screws and the tightening torque should be as follows:

Effective length of camera body: 3mm

Recommended tightening torque: 1N·m.

See the outline drawing of camera below for the possible surfaces and screw mounting patterns.

### *Hardware 2.1.4 Spectroscopic Camera Specifications*

An optional camera tripod mount can be used to mount the Spectroscopic Camera on a commercial optical base table. Make sure that the 1/4-20 UNC screws are not pierced to the camera tripod mount before using them.

If the camera is installed on a vibrating device or on a moving part, such as a robot arm, the connector must be secured to prevent the camera from disconnecting the cable.

The USB 3.0 cable can be secured with a screw lock on the connector.

Secure the USB2.0 cable with a commercially available cable lock.

The following products have been verified to be able to be fixed to the Spectroscopic Camera:

Manufacturer: AVANTEC

Order number: AUK-01-01-Y



Due to Spectroscopic Camera is the nature of precision optical electronics, be sure to satisfy following:

1. Storage and operating environment

- Do not apply any shock or bending stress to the product.
- Do not use or store the product in an environment where condensation may form.
- Do not use or store the product in an environment where water droplets can get on the product.
- Do not use or store in an environment exposed to salt water or corrosive gases.
- If you remove the lens from the camera and store it, replace the cap that came with the camera or lens and store it.
- Do not place it on moving parts with repeated rapid braking or use it in repeated impacts. (Approximate: 8G)

2. Handling Precautions

- Do not contaminate the window on the lens mounting of the product with any dirt or dust.  
If dirt or dust attached, remove it with air blowing or a dry soft cloth.
- The product is not waterproof. Do not wash with liquid.  
Do not use chemicals.
- Do not disassemble the product.
- Do not touch the window on the lens mounting of the product with your fingers.

3. Transport precautions

- Keep away from shocks or vibrations to Spectroscopic Camera.

## 2.4 Spectroscopic Camera Specifications

| Item                   | Specification                |
|------------------------|------------------------------|
| Model Name             | SV-700S                      |
| Resolution             | 1024 × 768                   |
| Pixel Size [mm]        | 1.67 × 1.67                  |
| Valid pixel range [mm] | 1.71 × 1.28                  |
| Shutters               | Rolling                      |
| Ambient Temperature    | 5 ~ 40 °C                    |
| Relative Humidity      | 20% to 80% (non-condensing)  |
| Size                   | Refer to the diagram         |
| Weight                 | Approx. 175 g (without lens) |
| Lens mount             | C-mount                      |
| Wavelength region      | 400nm ~ 700nm                |
| Wavelength step        | 20nm                         |

There is no external trigger or strobe interaction.

### Outline Drawing of Spectroscopic Camera

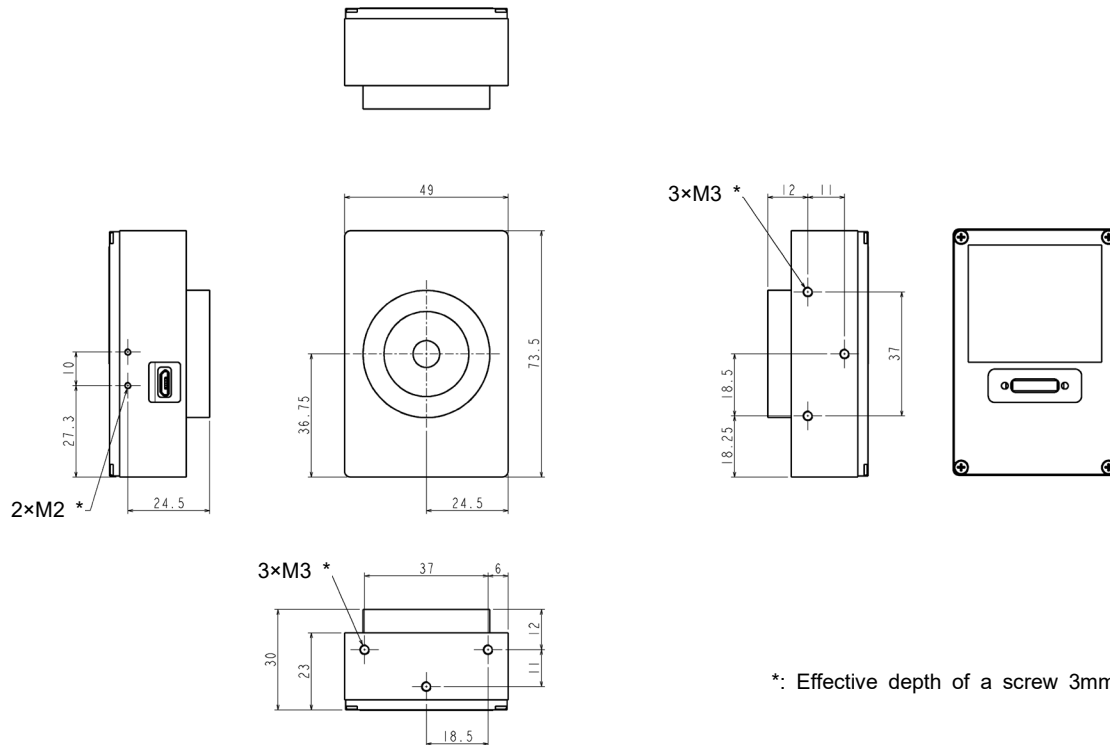

## 2.5 Characteristics of Spectroscopic Camera

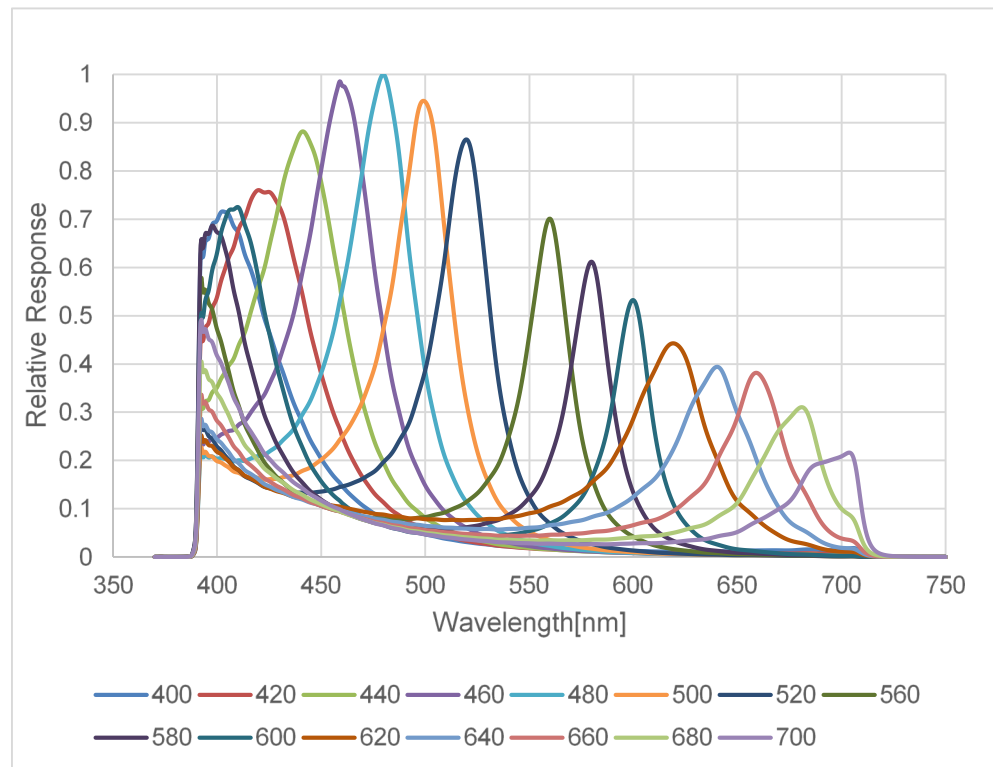

## 2.6 Individual Variability in Measurement Systems Including Spectroscopic Camera

There are individual variabilities in Spectroscopic Camera due to variations in camera parts dimensions, assembly, lens, spectroscopic filters, image sensor, etc. In addition, as a measurement system, it is necessary to consider individual variabilities in lighting and differences in the installation position of lighting, Spectroscopic Camera, and workpieces.

It is recommended to perform relative inspection. The inspection registers PASS or FAIL products and inspects (per measurement system basis).

# 3. Camera Lens

It is recommended to use Spectroscopic Camera in combination with “3.2 megapixel lens (HF)”.

## 3.1 Megapixel Camera Lens

### 3.1.1 Lens Specification

| Item                      | Unit | Specification |               |               |               |               |
|---------------------------|------|---------------|---------------|---------------|---------------|---------------|
| Focal length              | mm   | 8             | 12            | 16            | 25            | 50            |
| Closest approach distance | m    | 0.1           | 0.15          | 0.3           | 0.3           | 0.5           |
| Filter screw diameter     | mm   | M30.5 × P0.5  | M30.5 × P0.5  | M30.5 × P0.5  | M30.5 × P0.5  | M30.5 × P0.5  |
| External dimensions       | mm   | ø 33.5 × 28.2 | ø 33.5 × 28.2 | ø 33.5 × 28.2 | ø 33.5 × 36.0 | ø 33.5 × 38.2 |
| Weight                    | g    | 62.6          | 61.9          | 60            | 71.2          | 85            |

P0.5: Screw Pitch 0.5 mm

### 3.1.2 Outline Drawing

M814-MP2

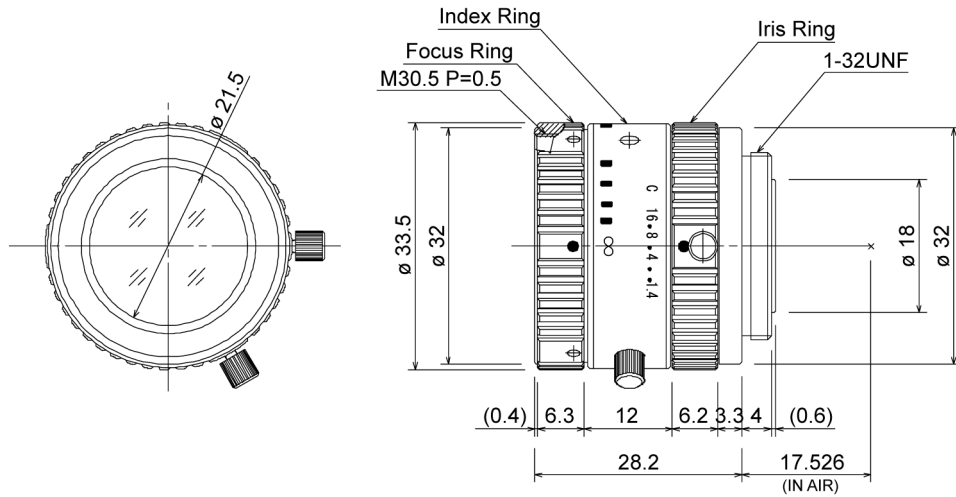

M1214-MP2

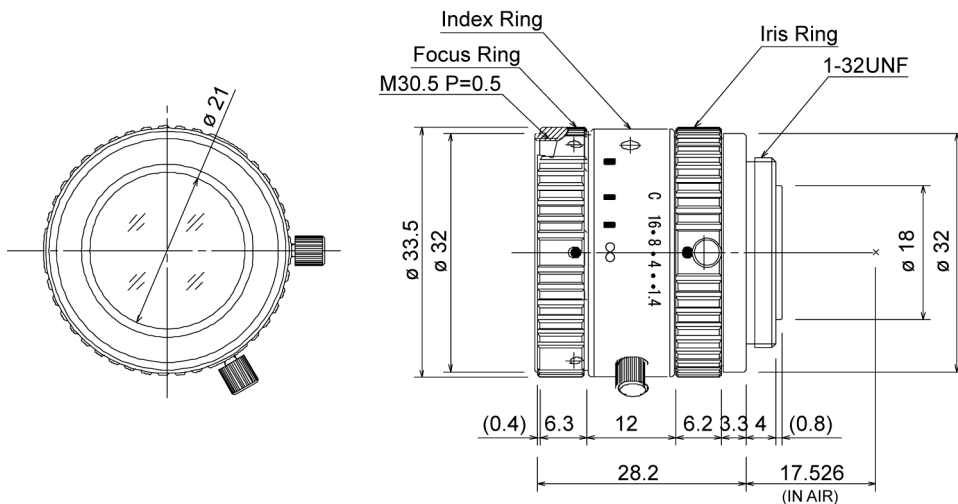

M1614-MP2

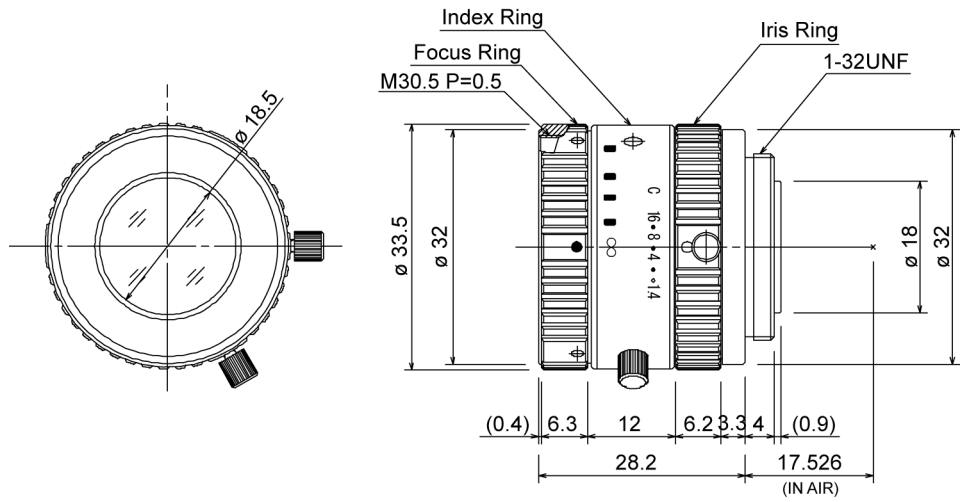

M2514-MP2

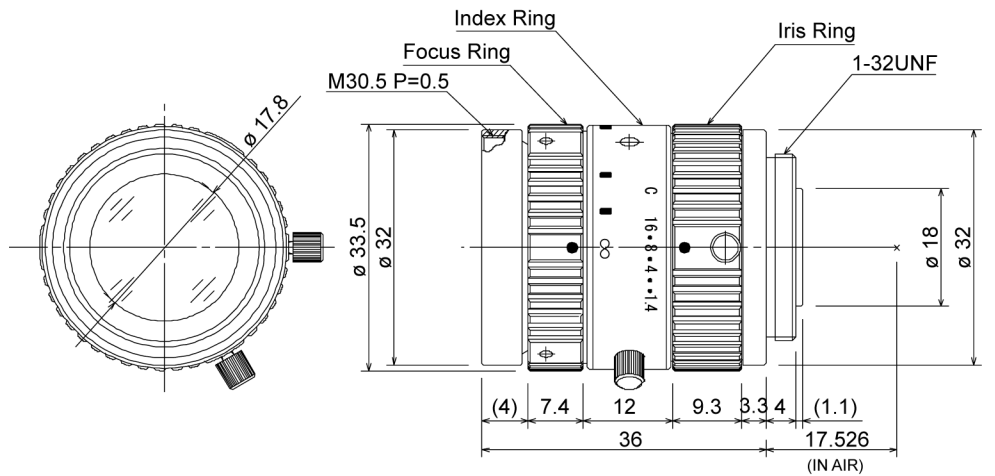

M5018-MP2

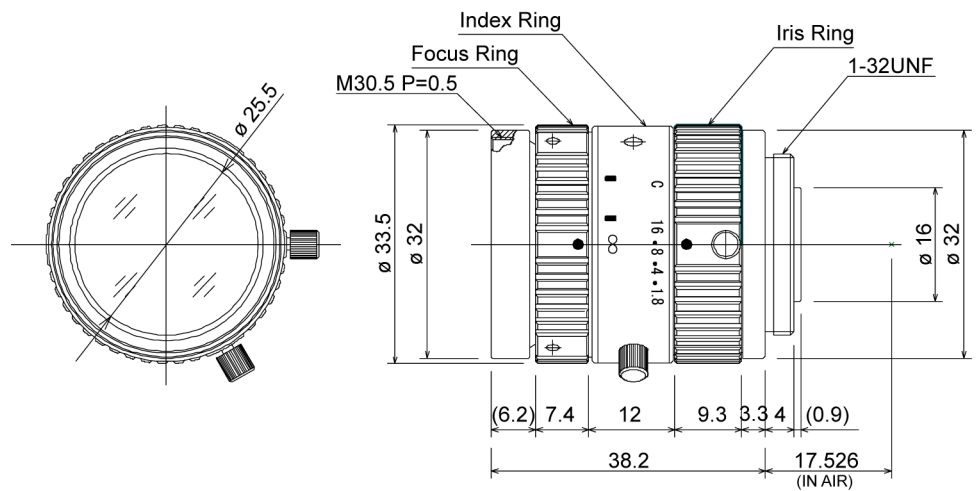

### 3.2 Megapixel Camera Lens (HF)

#### 3.2.1 Lens Specification

| Item                      | Unit | Specification |              |              |              |              |
|---------------------------|------|---------------|--------------|--------------|--------------|--------------|
| Focal length              | mm   | 8             | 12           | 16           | 25           | 35           |
| Closest approach distance | m    | 0.1           | 0.1          | 0.1          | 0.1          | 0.2          |
| Filter screw diameter     | mm   | M30.5 × P0.5  | M30.5 × P0.5 | M30.5 × P0.5 | M30.5 × P0.5 | M30.5 × P0.5 |
| External dimensions       | mm   | ø 33 × 48.5   | ø 33 × 52.5  | ø 33 × 52.5  | ø 33 × 53.1  | ø 33 × 53.1  |
| Weight                    | g    | 95            | 85           | 90           | 85           | 85           |

P0.5: Screw Pitch 0.5 mm

Extension tubes larger than 5 mm thick cannot be fitted.

#### 3.2.2 Outline Drawing

HF818-12M

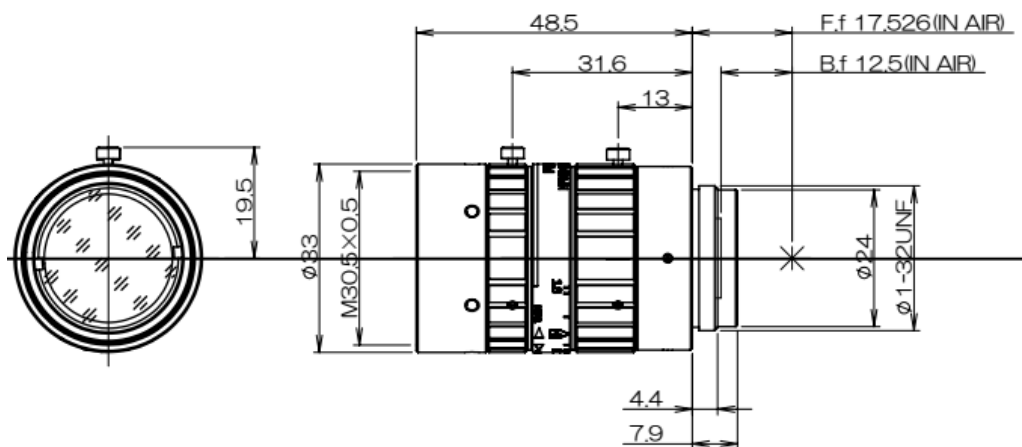

HF1218-12M

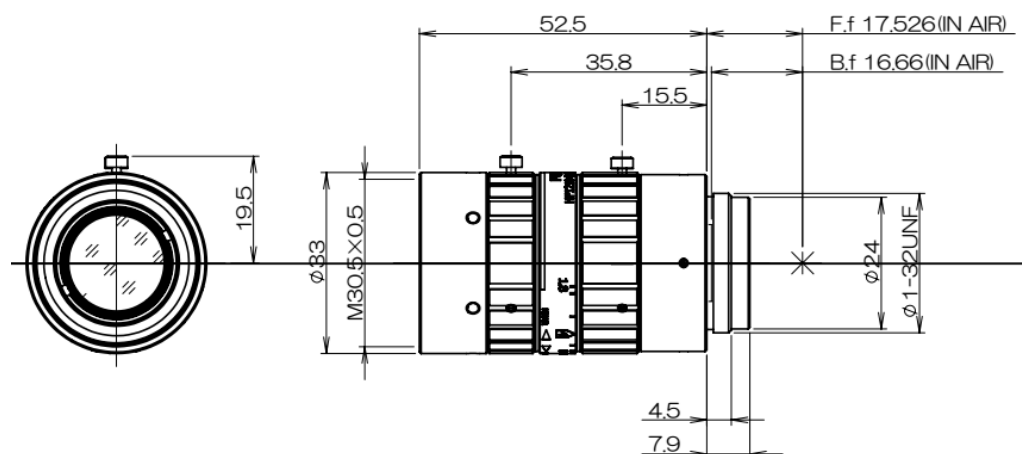

HF1618-12M

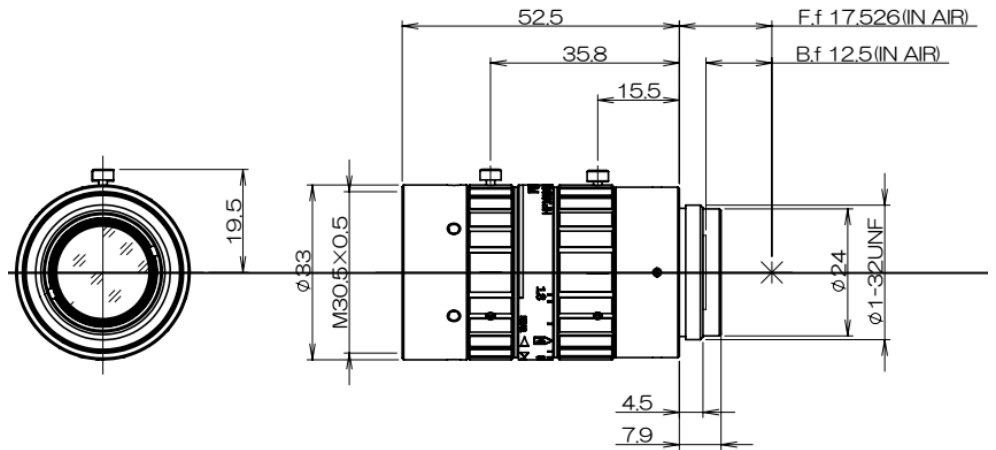

HF2518-12M

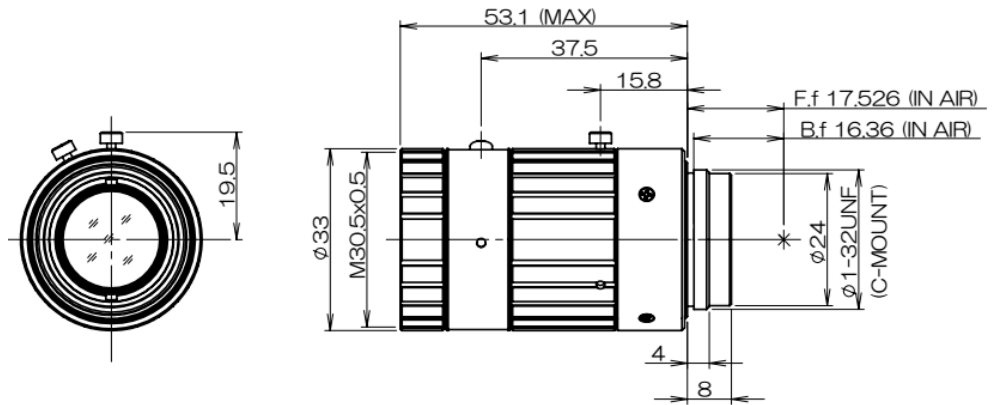

HF3520-12M

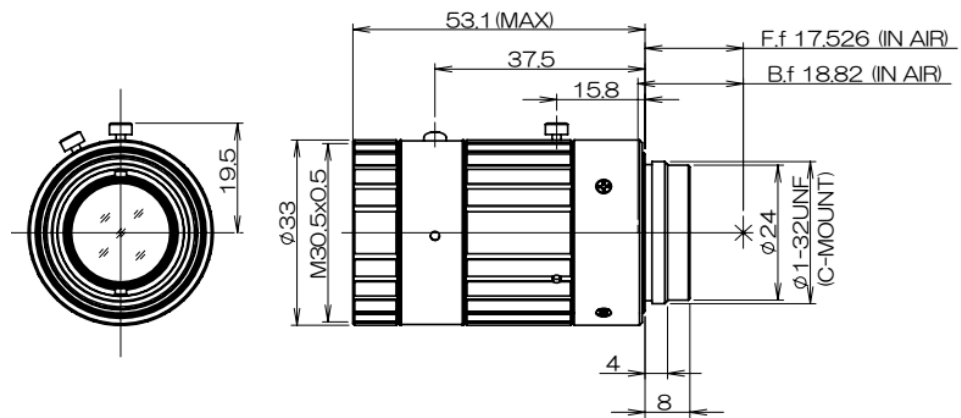

## 4. Option Product Specifications

### 4.1 A/C adaptor

#### 4.1.1 Specifications

|                         |                                   |
|-------------------------|-----------------------------------|
| External dimensions     | W 177 mm × D 86 mm × H 32.3       |
| AC input                | 100 – 240V, 3A, 50 ~ 60Hz         |
| DC output               | 24V, 9.58A                        |
| Cable length            | 1500mm                            |
| Socket type             | C14                               |
| Operating temperature   | 0 to 40 °C.                       |
| Rated Relative Humidity | 20% to 80% (with no condensation) |

#### 4.1.2 External dimensions

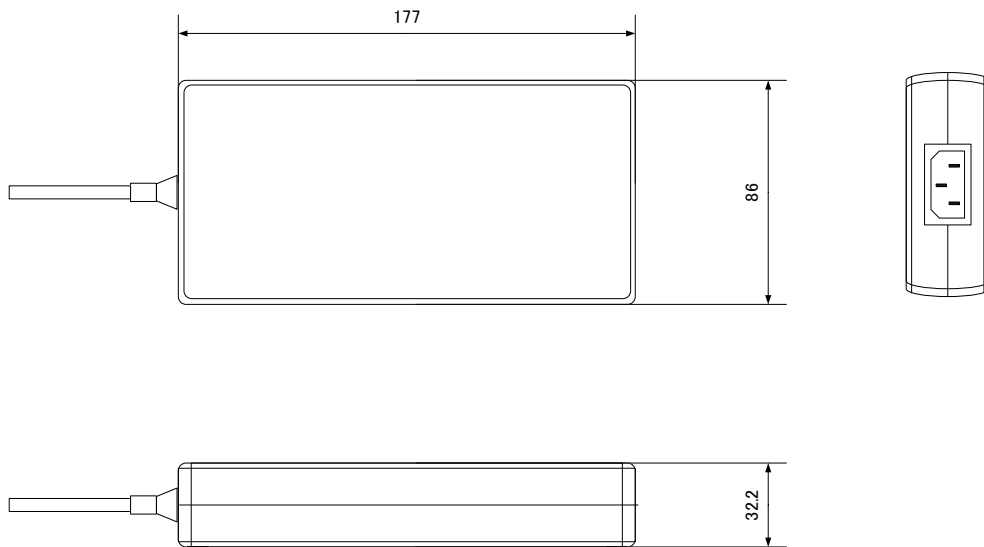



## 4.2 Camera Tripod Mount

### 4.2.1 Specifications

|                     |                               |
|---------------------|-------------------------------|
| External dimensions | W 49 mm × H 7 mm × D 20 mm    |
| Applicable screws * | 1/4-20 UNC (do not penetrate) |

\* three mounting screws (M3) on the Spectroscopic Camera side are included in the box.

### 4.2.2 Dimensions

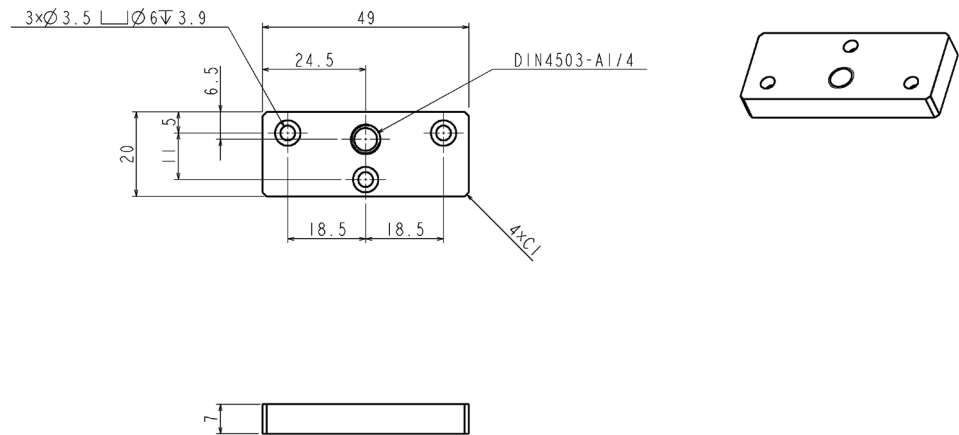

## 4.3 Software Adding Option

### SV-Software\_I:

This is the option including the installer to add EPSON RC+ VisionGuide.

The customers who selected only Epson SV Tools when purchasing Spectroscopic Vision System, use this option to add the software.

### SV-Software-O:

This is the option including the installer to add Epson SV Tools.

The customers who selected only EPSON RC+ VisionGuide when purchasing Spectroscopic Vision System, use this option to add the software.

For the differences between EPSON RC+ Vision Guide and Epson SV Tools, refer to *Installation "1.2 To Users of EPSON RC+ 7.0 Vision Guide" - "Differences in Function between Epson SV Tools and EPSON RC+ Vision Guide"*.

The software can only be used with specified spectroscopic vision controllers. When purchasing, inform supplier of the serial number starting with "KSA" and the option key starting with "USB" shown on the bottom of Spectroscopic Vision Controller CV2-SV. For details of the option key, refer to *Setup "5. Software Option Key"*.

## 5. Maintenance Parts List

| Part Name                               | Code    | Note             |
|---|---------|------------------|
| CV2-SV (IOP) ASP                        | 2218304 | For SV-700S-CVIO |
| CV2-SV(O) ASP                           | 2218303 | For SV-700S-CVO  |
| CPU Board                               | 2175328 |                  |
| PoE Board-A.                            | 2204519 |                  |
| LED/SW Board                            | 2168504 |                  |
| Memory                                  | 2168500 | 8GB              |
| CFast                                   | 2218306 | For CV2-SV (IOP) |
|   | 2218305 | For CV2-SV(O)    |
| CFast for CV2-SV (IOP)                  | 2213263 |                  |
| Battery                                 | 2168507 |                  |
| Chassis Fan                             | 2168505 |                  |
| Fan Filter                              | 1653513 |                  |
| Power Supply Connector                  | 2168506 |                  |
| Mounting Bracket                        | 1653498 |                  |
| Spectroscopic Camera USB3.0 cable (3 m) | 2218307 |                  |
| Spectroscopic Camera USB2.0 cable (3 m) | 2218308 |                  |

## 6. Option

| Part Name                           | Code       |            |
|-------------------------------------|------------|------------|
| CV2 A/C Adapter                     | R12NZ901A1 |            |
| Spectroscopic Camera Tripod Adapter | R12NZ9019Z |            |
| SV-Software I                       | R12NZ901BU |            |
| SV-Software O                       | R12NZ901BV |            |
| Megapixel Camera Lens               | 8 mm       | R12NZ900AU |
|                                     | 12 mm      | R12NZ900AV |
|                                     | 16 mm      | R12NZ900AW |
|                                     | 25 mm      | R12NZ900AX |
|                                     | 50 mm      | R12NZ900AY |
| Megapixel Lens (HF)                 | 8 mm       | R12NZ9010F |
|                                     | 12 mm      | R12NZ9010G |
|                                     | 16 mm      | R12NZ9010H |
|                                     | 25 mm      | R12NZ9010J |
|                                     | 35 mm      | R12NZ9010K |
| Camera Extension Tube Kit           | R12NZ900BG |            |

# Setup



# 1. Foreword

This chapter describes the following topics.

- OS setup and backup
- Application software setup
- Software option key
- Unified write filter

Work in the following order according to your purchasing case of Spectroscopic Camera and Spectroscopic Vision Controller. If necessary, do the OS backup and unified write filter.

When you bought Spectroscopic Camera and Spectroscopic Vision Controller at the same time:

1. OS setup
2. Application software setup

When you already had an OS setup Spectroscopic Camera and Spectroscopic Vision Controller, and then bought Epson SV Tools:

1. Application software setup
2. Software option key

## 2. OS Setup

Customers who are setting up the OS should prepare a monitor, mouse, and keyboard.

### 2.1 About OS

The system's OS is customized to run Microsoft Windows 10 IoT Enterprise for the system's embedded application software to work optimally.

Use the network connection with a local network that cannot connect to the external Internet.

Connecting to a network that can connect to the external Internet presents a risk of security breaches, changes in the environment due to software updates, and a loss of safe and stable operation.

Always press the <Power SW> button on the Spectroscopic Vision Controller or shut down Windows to turn off the power.

When turning the power OFF by using a breaker, install UPS (uninterruptible power source) and be sure to have UPS perform automatic shutdown.

#### Windows Customization Overview

Firewall: Disabled

Windows Update Automatic Updates: Disabled

Setting of Unified Write Filter (default: Disabled)

#### PoE IP address

| Port | IP Address   | Subnet Mask   |
|------|--------------|---------------|
| CH1  | 192.168.11.1 | 255.255.255.0 |
| CH2  | 192.168.12.1 | 255.255.255.0 |
| CH3  | 192.168.13.1 | 255.255.255.0 |
| CH4  | 192.168.14.1 | 255.255.255.0 |

#### IP address of the LAN

| Port | IP Address |
|------|------------|
| LAN1 | Automatic  |
| LAN2 | Automatic  |

## 2.2 OS Setup

The first time you turn on the Spectroscopic Vision Controller CV2-SV, the OS setup screen appears.

Follow steps below to set up OS:

|   |   |
|---|---|
| <br><b>CAUTION</b> | <ul style="list-style-type: none"> <li>■ Throughout the OS setup, do not connect the external drive (USB flash drive, SSD, HDD, optical drive). If you connect the drive, the OS setup may not be performed.</li> <li>■ Throughout the OS setup, do not connect the Spectroscopic Camera. If you connect the drive, the camera may not recognize it correctly.</li> </ul> |
|---|---|

- (1) Connect a monitor, keyboard, and mouse to the Spectroscopic Vision Controller.
- (2) Turn on the Spectroscopic Vision Controller CV2-SV.
- (3) The language selection is displayed.  
Select a language from the menu and click the <Yes> button.

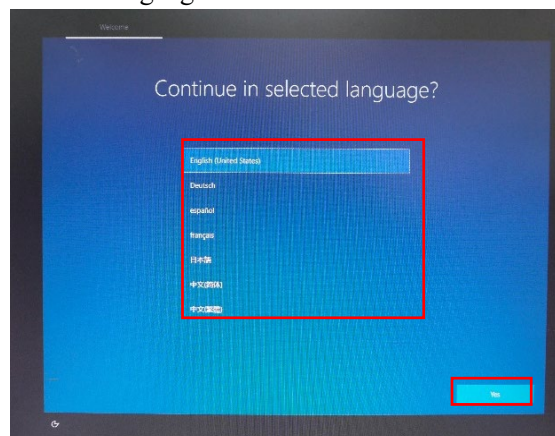

- (4) The region selection appears.  
Select your region from the menu and click the <Yes> button.

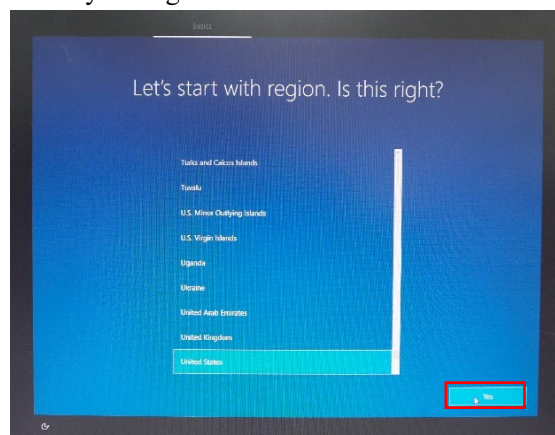

- (5) The keyboard layout selection appears.  
Select a keyboard layout from the menu and click the <Yes> button.

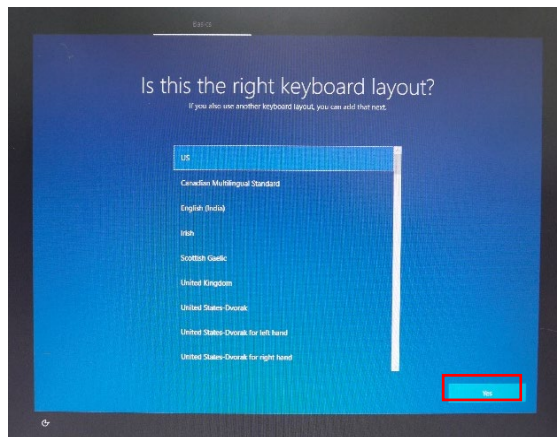

- (6) A second keyboard layout appears.  
Click the <Skip> button.

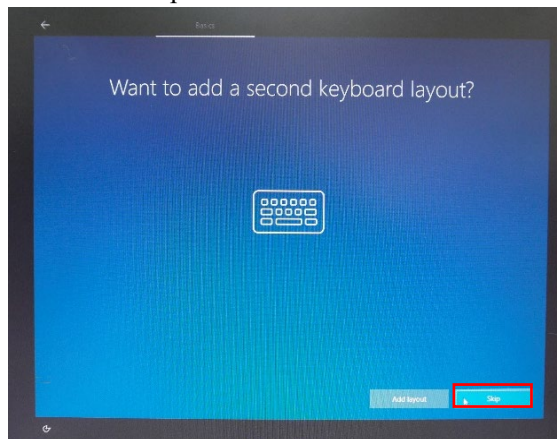



- (7) Entering the user name screen appears.  
Enter your user name and click the <Next> button.

The user name must be in ASCII printable characters.

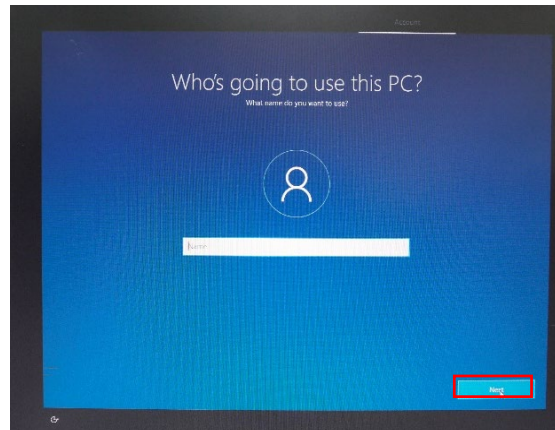

- (8) Entering the password screen appears.  
Enter your password and click the <Next> button.

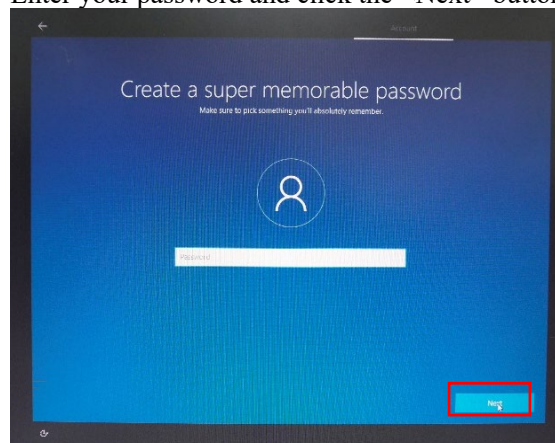

- (9) The Password and Security confirmation screen appears only if you have entered a password. Follow the instructions on the screen.
- (10) The activity history questions are displayed.  
Click the <No> button.

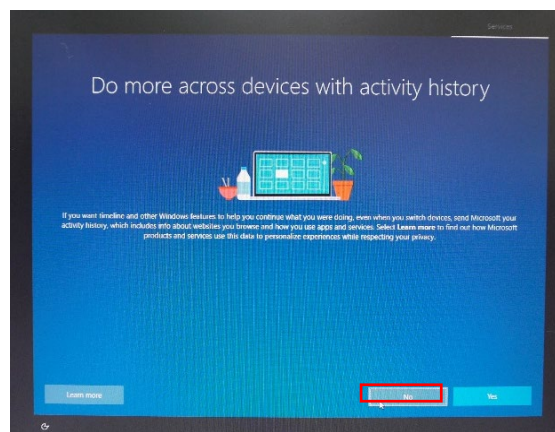



(11) Wait a few moments to complete Setup.



## 2.3 Setting Time Zone

When you set up OS, the time zone is set to Coordinated Universal Time (UTC).

Set the time zone to match the location of the Spectroscopic Vision Controller.

- (1) Click the <Start (  )> button, and then click the <Setting (  )> button.
- (2) The Windows settings appear.  
Click <Time and Language>.

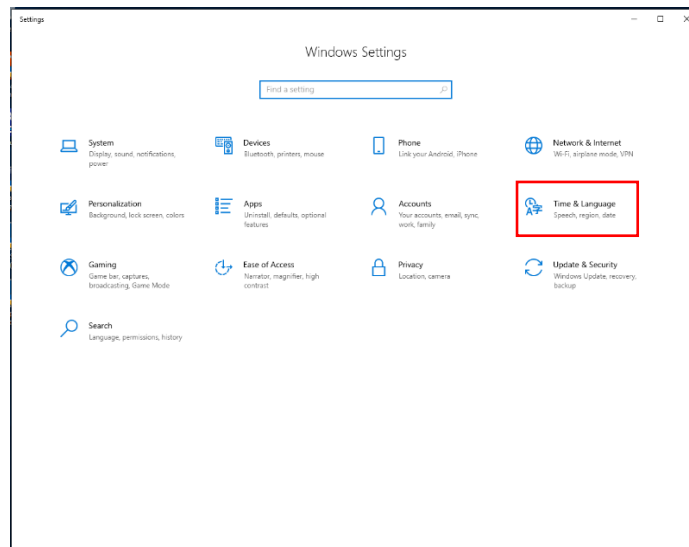

- (3) The date and time settings are displayed.

Click the time zone <  > button.  
Select the time zone from the list.

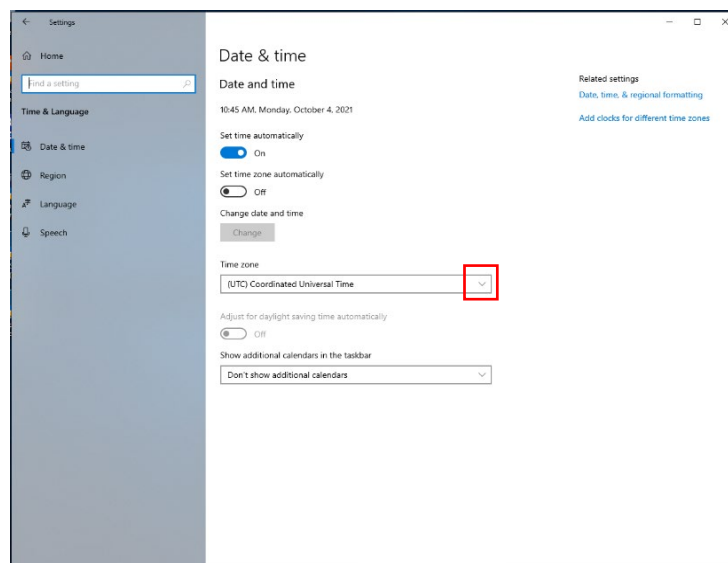

- (4) Click the <  > button for Date and Time Settings.

## 3. Backup (Creating and Restoring an Image)

The customer must have an external optical drive (such as USB-DVD) and optical recording media (such as DVD-R/DVD-RW) available to create or restore a backup image.

This system cannot be reset all data to the factory default.

In case of data corruption, destruction or extinction, all data must be stored on external recording media and stored in a safe place.

The following examples show how to use DVD-R media and a USB-connected DVD drive that can write to it.

The displayed contents and procedures may differ depending on the drive and media used.

Perform the operation according to the displayed contents.

Backup creation and restore time vary depending on your drive, media, and storage space. It may take approximately 1 to 2 hours to complete right after the OS setup.

### 3.1 Creating an Image

Creating image of the drive.

- (1) Connect the USB of the optical drive to the Spectroscopic Vision Controller.
- (2) Click the <Start (  )> button and choose [Windows System Tool] - [Control Panel].
- (3) The Control Panel appears.  
Select [System and Security] - [Backup and Restore (Windows 7)].

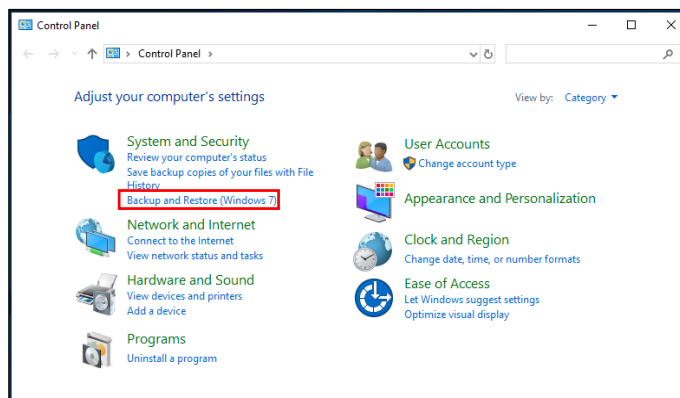

- (4) Backup and Restore (Windows 7) appears.  
Select [Create a system image].

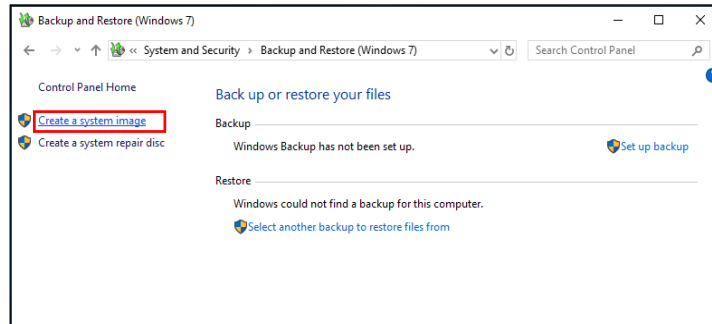

- (5) The Create System Image appears.  
Select [On one or more DVDs] and click the <Next> button.

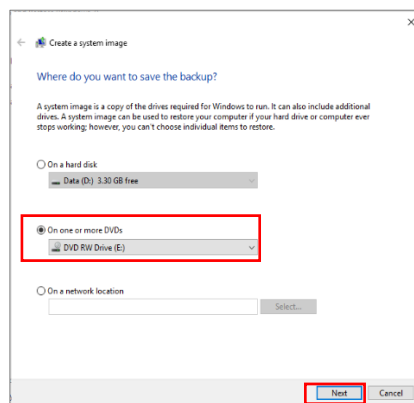

- (6) The backup selection appears  
Click the check box to [Data (D:)].  
Click the <Next> button.

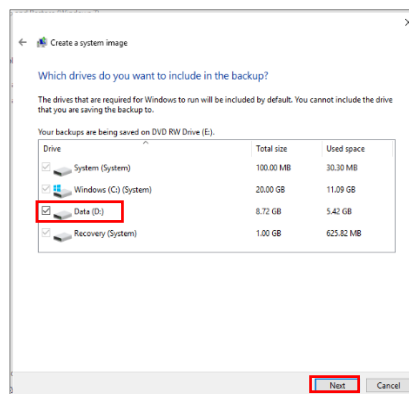

## Setup 3. Backup (Creating and Restoring an Image)

---

- (7) A confirmation of the backup configuration appears.  
Click the <Start backup> button.

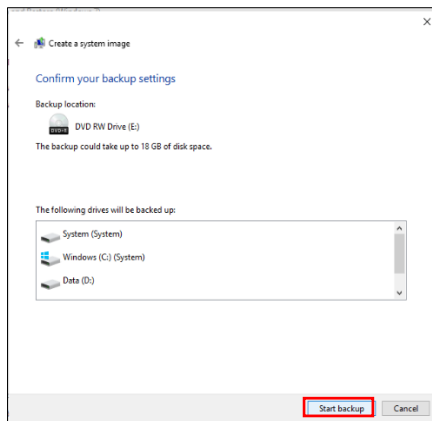

- (8) Follow the instructions until following message appears:  
Click the <Yes> button.

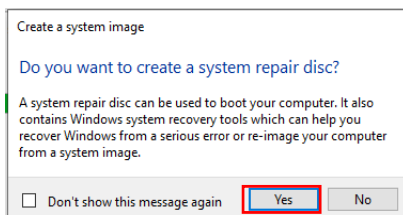

- (9) Insert writable media into the optical drive if the following message appears:  
Click the <Create disc> button.

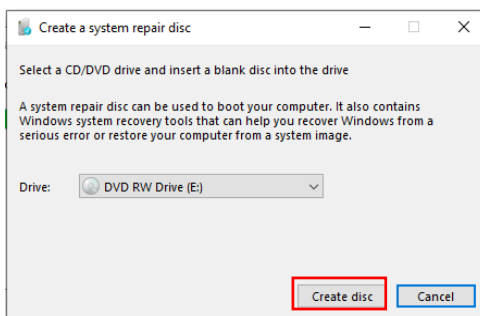

- (10) If the following message appears, follow the instructions.  
Click the <Close> button.

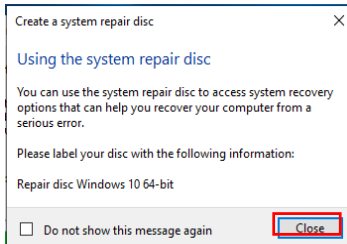

(11) Click the <OK> button when you are finished creating a system repair disc.

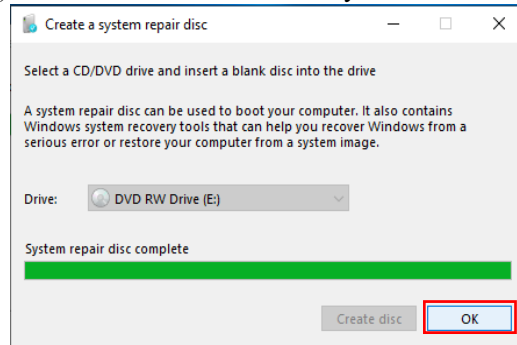

(12) Click the <Close> button.

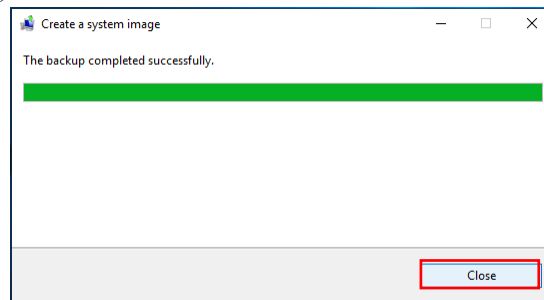

(13) Click the <X> button on the [Backup and Restore (Windows 7)] screen.

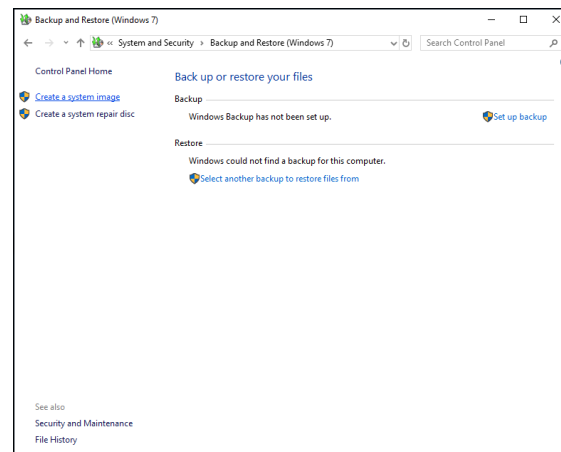

## 3.2 Restoring an Image

Delete all current data and restores it to the state it was in when the image was saved. Do this if problem occur with the operation of your system.

- (1) Connect the USB of the optical drive which the system repair disc is set to the Spectroscopic Vision Controller.
- (2) Turn on the Spectroscopic Vision Controller.
- (3) When the screen displays “Press any key to boot from CD or DVD...” or “Drecker Sie eine beliebige Taste, um von CD oder DVD zu booten ...”, press any key on the keyboard.
- (4) The language selection is displayed.  
Select a language.

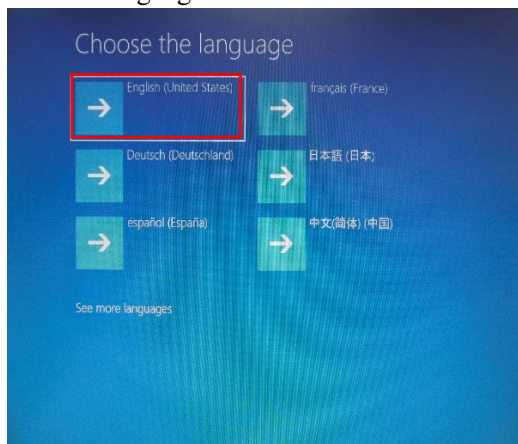

- (5) The keyboard layout selection appears.  
Click the keyboard layout.

If you selected “English” for Language, select “US”.

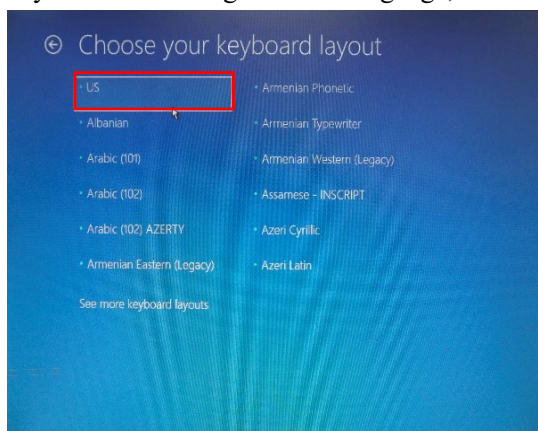



- (6) The option selection appears.  
Select [Troubleshoot].

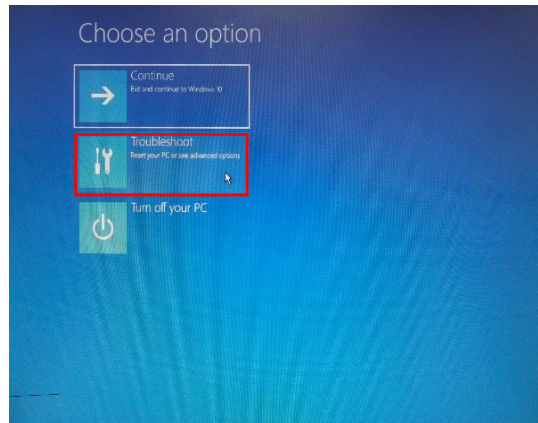

- (7) The detailed options appear.  
Select [System Image Recovery].

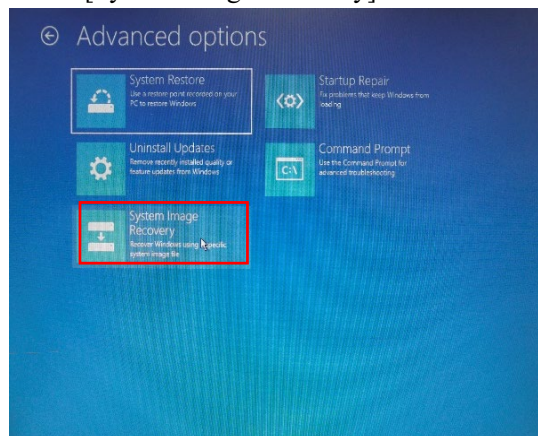

- (8) The Restore System with Image appears.  
Select [Windows 10]

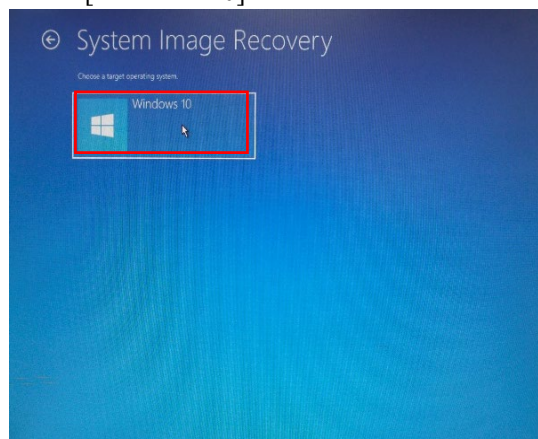

### Setup 3. Backup (Creating and Restoring an Image)

---

- (9) Follow the contents displayed, insert the disc with the final image created into the drive.

Click the <Retry> button.

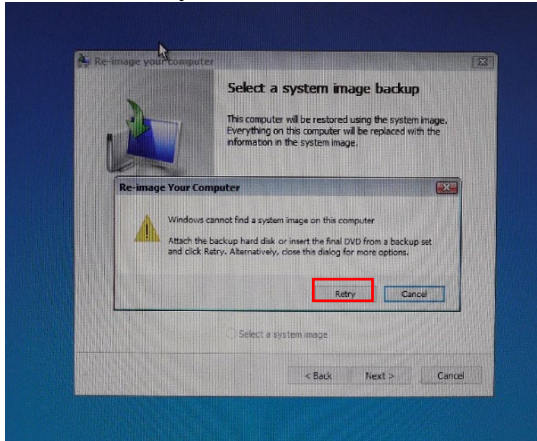

- (10) Confirm the contents.

Click the <Next> button.

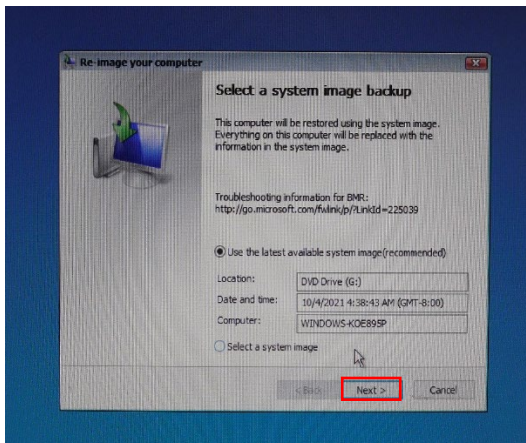

- (11) Reapplying computer Image is displayed.

Click the check box to [Format and repartition disks].

Click the <Next> button.

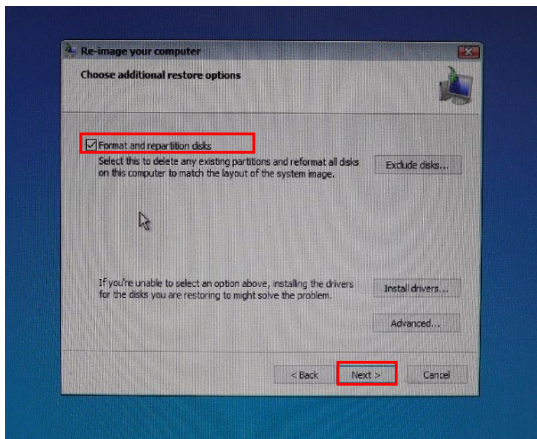

(12) The Review Contents screen appears.

Click the <Finish> button.

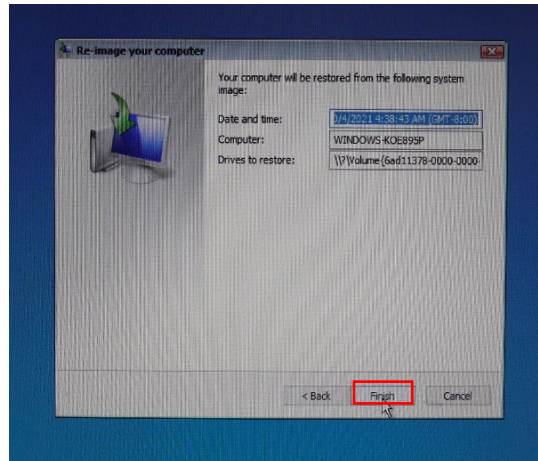

(13) Reapplying computer Image is displayed.

Click the <Yes> button.

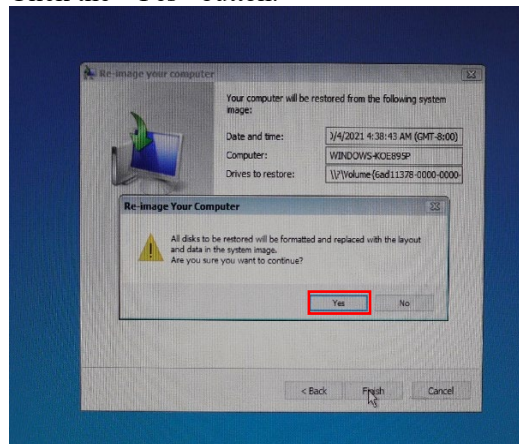

(14) The disk swapping appears multiple times.

Swap the discs according to the information displayed.

Click the <OK> button.

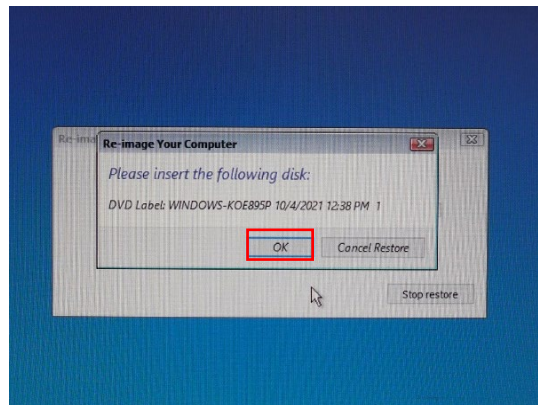

## Setup 3. Backup (Creating and Restoring an Image)

---

(15) Click the <Restart now> button when the following message appears:

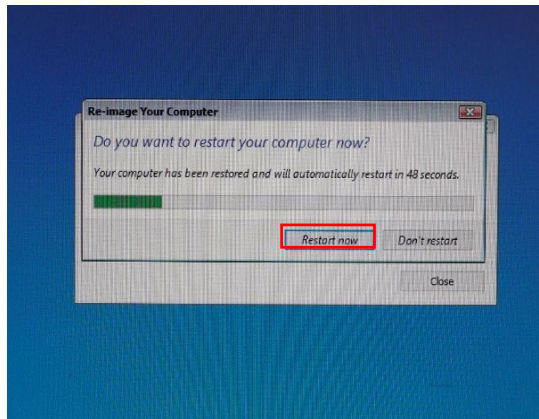

## 4. Epson SV Tools Setup

### 4.1 Installation

- (1) Disable the protection function of unified write filter.

For details of setting the unified write filter, refer to “6. Setting the Unified Write Filter.”



- (2) Double-click the <Setup Epson SV Tools> icon (  ) on the Windows desktop.
- (3) User Account Control appears. To display the screen can take time.

Click the <Yes> button.



NOTE

When you need to uninstall Epson SV Tools, the following window appears.

Refer to “4.2 Uninstallation” to uninstall the software.

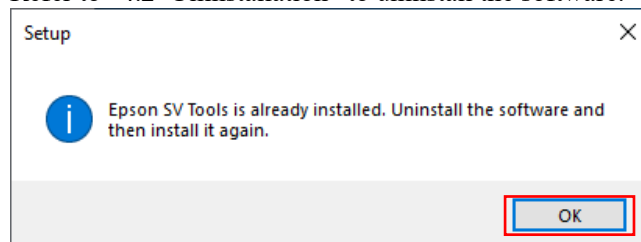

- (4) The following wizard appears. Click the <Next> button.

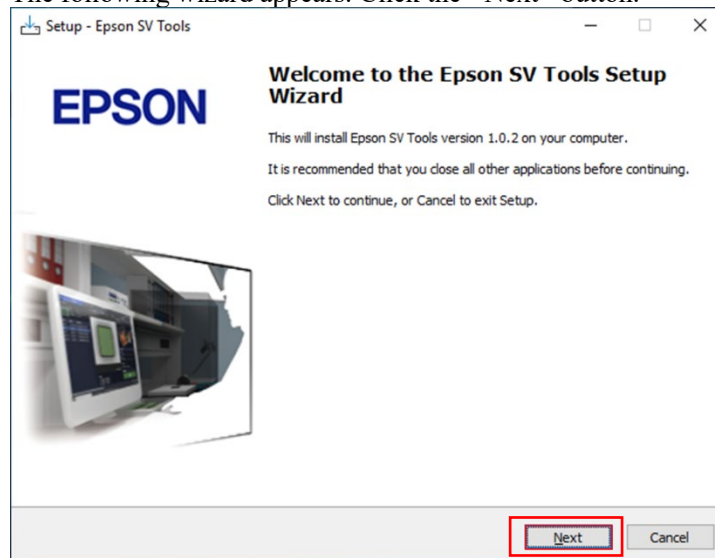

- (5) The requirements to be installed appear according to the installing status.

When the requirements appear, click the <Install> button.

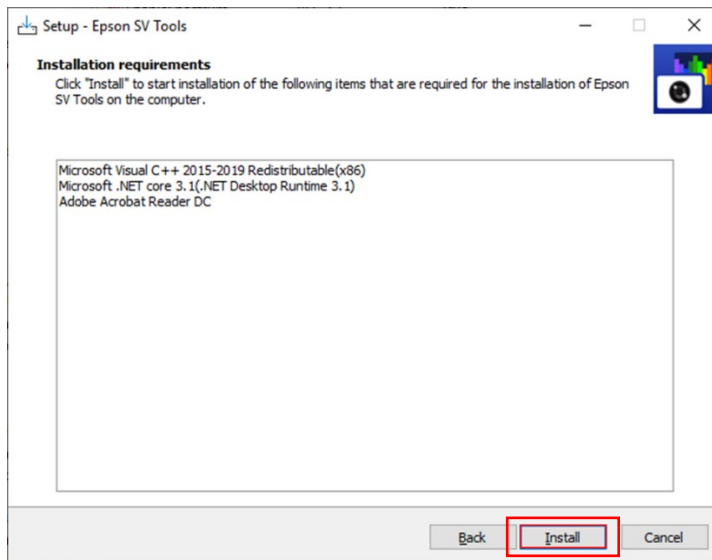

NOTE Adobe Reader is required to show manuals. When your computer does not have Adobe Reader, Adobe Reader will be installed.

- (6) License Agreement appears.

Read License Agreement and select whether to accept.

Only when you selected <I accept the agreement>, click the <Next> button.

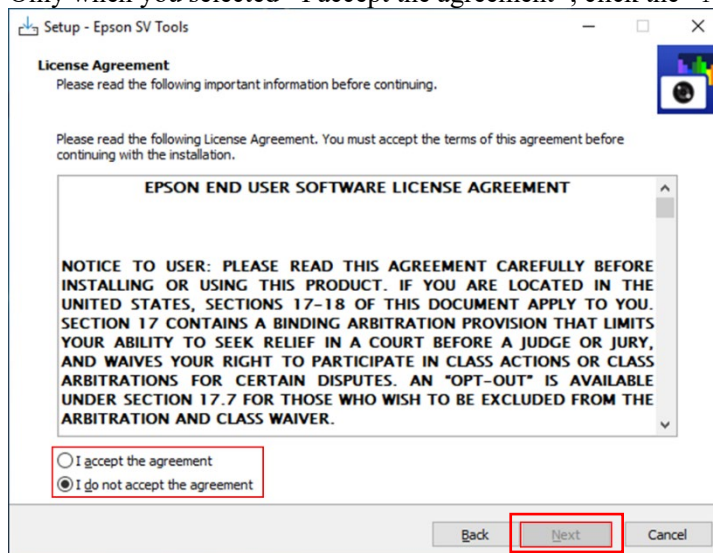

- (7) The window be ready to install appears.  
Click the <Install> button.

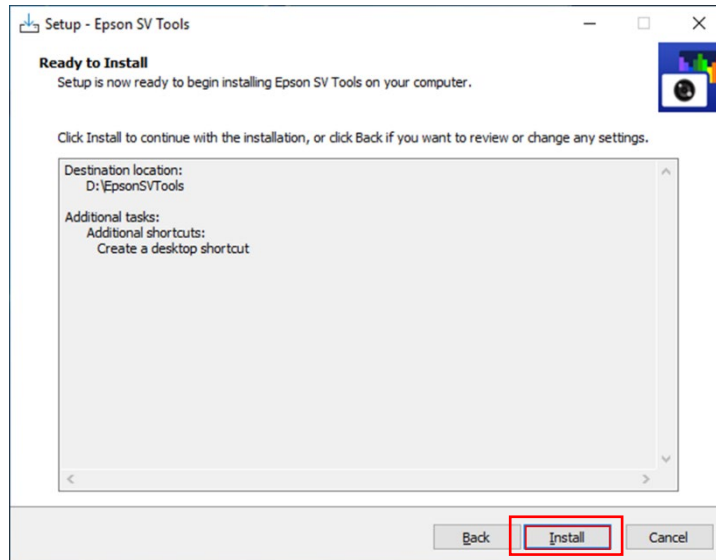

- (8) The window to complete the installation appears.  
Click the <Finish> button.

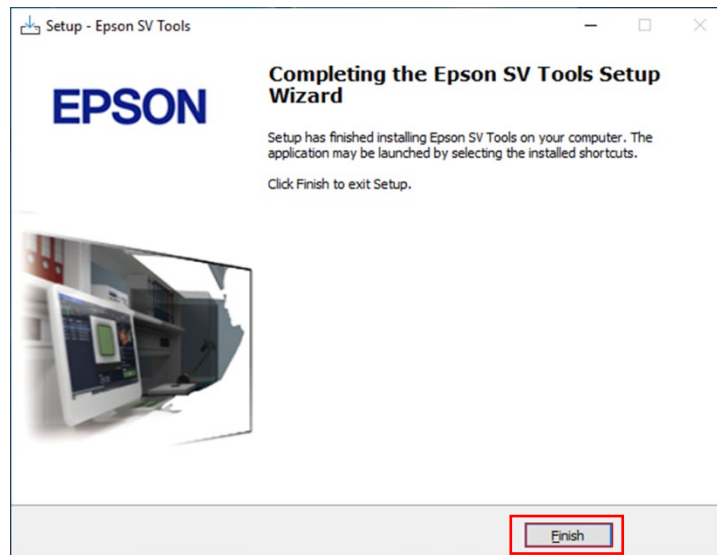



## 4.2 Uninstallation

Uninstallation may be required due to version upgrades, etc. Follow the procedure below to uninstall.

- (1) Disable the protection function of unified write filter.

For details of setting the unified write filter, refer to “6. *Setting the Unified Write Filter.*”

- (2) Click the <Start (  )> button and then click the <Settings (  )> button.
- (3) The settings of Windows appears. Click the <Apps> button.

The screen can be different depending on your PC environment.

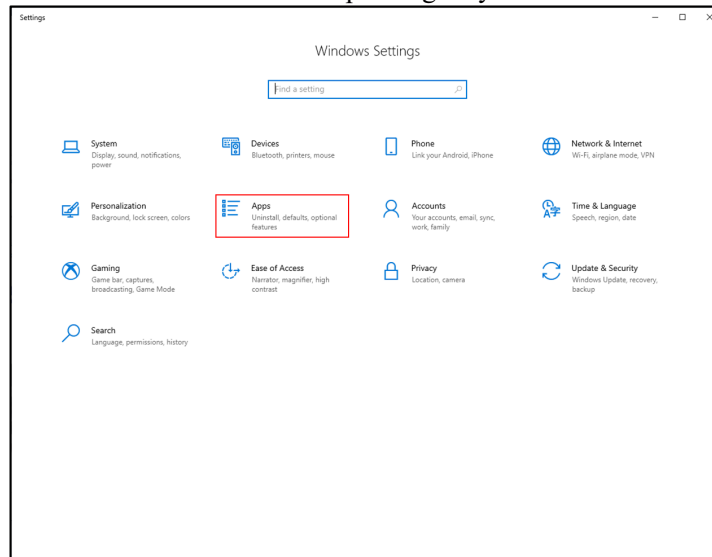

- (4) The setting window for applications and features appears.

Click [Apps & features] - [Epson SV Tools version x.x.x].

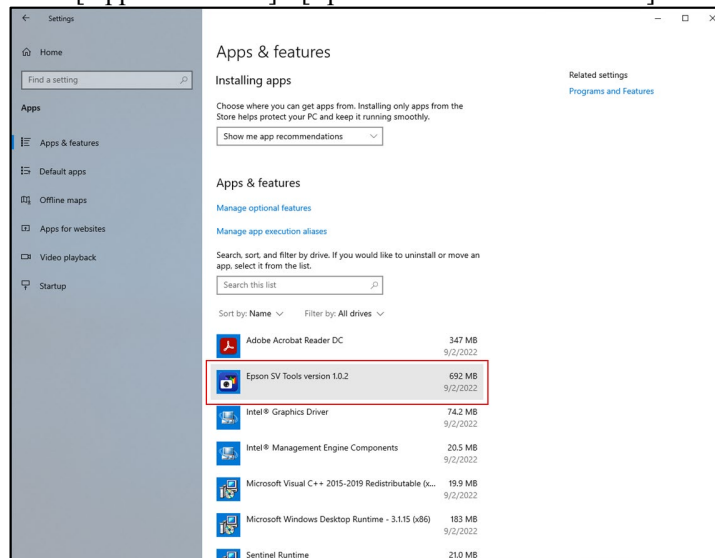



- (5) The details appear.  
Click the <Uninstall> button.



- (6) The following message appears.  
Click the <Uninstall> button.

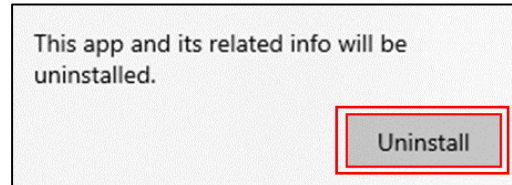

- (7) User Account Control appears.  
Click the <Yes> button.
- (8) The window for uninstallation appears.  
Follow the direction on the window to uninstall.

## 5. Software Option Key

If you have the following devices, you have to activate the software option key after you set up the application software.

- Spectroscopic Camera with OS setup completed
- A set of Spectroscopic Vision Controller

### 5.1 Preparing for Epson SV Tools Option Key

Before using Epson SV Tools, you must register the software option key. Follow the procedure below to inform supplier of options key code to get Epson SV Tools activation code number.

- (1) When your computer has not EPSON RC+7.0, install the software.
- (2) Double-click the <EPSON RC+7.0> icon on the desktop to start EPSON RC+7.0. When a hint appears, after starting EPSON RC+7.0, click the <OK> button to close.
- (3) Click [Setup]-[PC to Controller Communications] from menu. The [PC to Controller Communications] dialog box appears.

## Setup 5. Software Option Key

- (4) Select [C4 Sample] from connection list and click the <Connect> button.

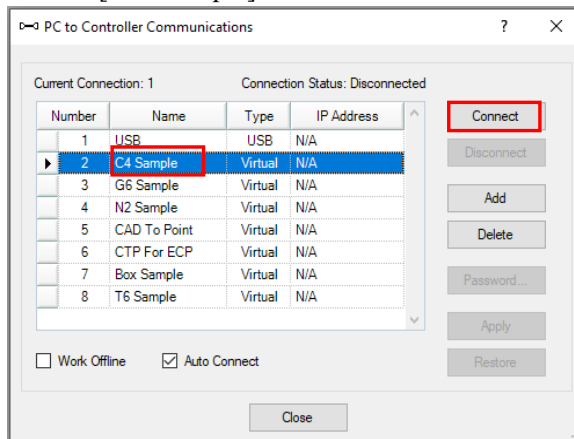

- (5) When the “Connection Status” is “Connected”, click the <Close> button.  
The [PC to Controller Communications] dialog box is closed.

- (6) Click [Setup]-[Options] from menu.  
The [Options] dialog box appears.

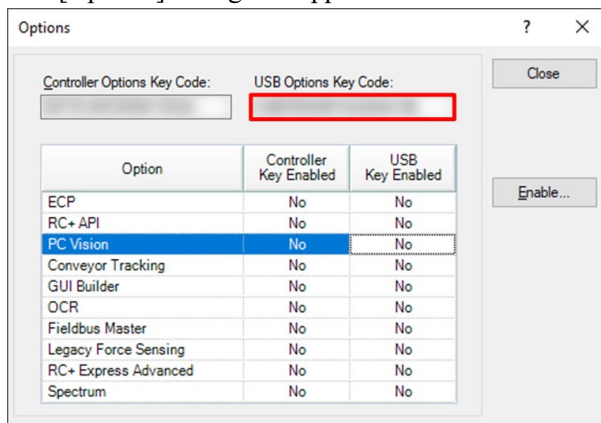

- (7) Correctly inform supplier of an alphanumeric code displayed in [USB Options Key Code].

The supplier will inform you of the only code that corresponds to the options key code.

- (8) When you continue to entering the code number, do the procedure (2) and after in “5.2 Registering Epson SV Tools Option Key”.

## 5.2 Registering Epson SV Tools Option Key

Prepare the activation code number informed by the supplier and follow the procedure below to register option key.

Note: Be sure to disable the protection function of unified write filter. For details of the unified write filter, refer to “6. Unified Write Filter”.

- (1) Get an activation code number.

For details of getting the activation code, refer to “5.1 Preparing for Epson SV Tools Option Key”.

- (2) Select [Epson SV Tools]-[Option] from Windows start menu.

- (3) The [Option for spectroscopic vision system] window appears.

Enter the activation code number correctly and click the <Activation> button.

Option setting for spectroscopic vision system

**Product Activation**

To use this optional product, you need to obtain the code to enable the option. For information on how to obtain the enable code, see the manual.

Enter the code you obtained to activate.

Options key code:

Enable code:

- (4) The activation result is displayed.  
When the activation is successful, click the <Close> button.

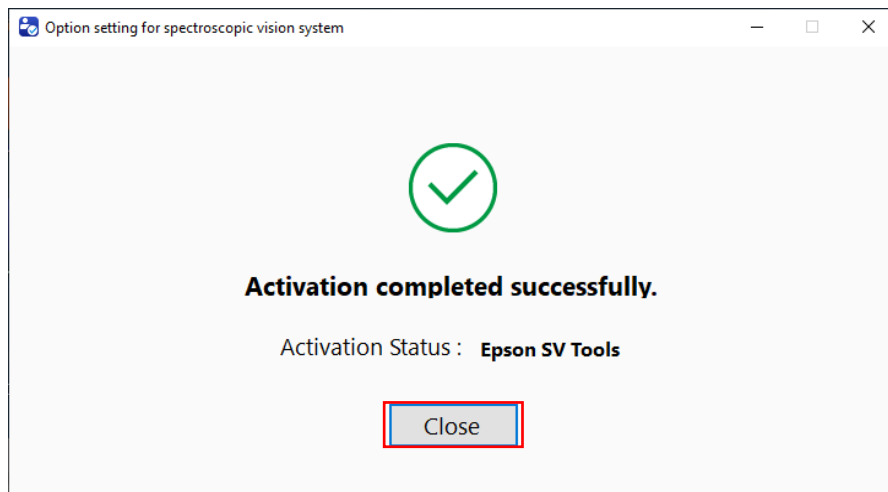

**NOTE**  

When the activation is not successful, click the <Back> button.

Enter the activation code number correctly again and click the <Activation> button.

## 6. Setting the Unified Write Filter

You can use the Windows Unified write filter to enable/disable The protection function.

When the protection function is enabled for the Unified write filter, changes to files and registries are not written directly to the recording device (CFast in this system). Instead, Changes are temporary retained in RAM. The changes are retained in RAM while the power is on, and can be used as before. When the power is turned off, all information in RAM is discarded. Before, The next time the power is turned on, the device can be returned to the same state as when the power was previously turned on

When you start using the Spectroscopic Vision System, enable the protection function to prevent unexpected data loss, data modification due to corruption or erroneous operation And detection of the recording device.

You can change the configuration of the Unified write filter Even if the protection function is enabled

System operations when the protection function is enabled and disabled Are town below.

### Protection function disabled

All changes are retained

All of the following operations are possible.

- Updating, adding, removing Windows functions
- Changing Windows settings
- Installing various applications
- Changing settings
- Saving, deleting files

Changes to settings and the deletion of files due to Erronous operations are also retained

The protection function is disabled by default after OS setup.

### Protection function enabled

Changes that are made on the protected target are discarded When the power is turned off.

The following operations will be discarded when the power is Turned off.

- Updating, adding, removing Windows functions
- Changing Windows settings
- Installing various applications
- Saving, modifying, deleting files on the protected target

The protected target is the C drive. (However, this does not include the C:\EpsonRC70 folder.)

All changes made on drives other than the protected target (Including changes to settings for the Unified write filter) are retained

An icon that indicates the Unified write filter setting is Displayed in the notification area of the taskbar. This allows You to check the setting of the Unified write filter.



Protection function enabled



Protection function disabled

An icon that indicates the Unified write filter setting is Also displayed on the desktop.

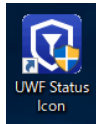

Protection function enabled

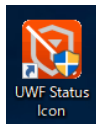

Protection function disabled

Note



The Unified write filter settings cannot be changed from this Icon.

- (1) Click the icon on the taskbar that identifies the Unified Write filter status.

You can configure the Unified write Filter.

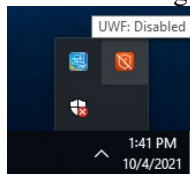

- (2) The Unified write filter setting is displayed.

To change the setting, click either Enable or Disable.

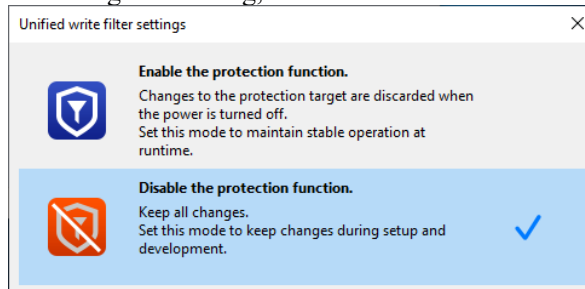

- (3) A confirmation dialog box for changing the Unified write filter setting is displayed.

To apply the change, follow the instructions in the dialog box, And then click the <Restart now> button.

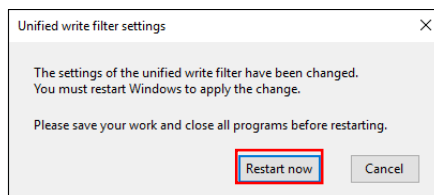

# Software





# 1. Starting the Software and Spectroscopic Camera Setup Procedure

This section describes how to start Epson SV Tools.

- Turn the power on
- Start Epson SV Tools
- Preparations to use the Spectroscopic Camera

## 1.1 Turn the Power On

Follow the procedure below to turn the power on.

- (1) Refer to the system configuration to connect the Spectroscopic Camera, Spectroscopic Vision Controller, monitor, keyboard, and mouse.
- (2) Turn the monitor and the Spectroscopic Vision Controller on.

## 1.2 Starting Epson SV Tools

Use either of the following methods to start Epson SV Tools.

**Method 1:**

Double click the <EpsonSVTools> icon on the Windows desktop.

**Method 2:**

- (1) Click the Windows <Start> button.
- (2) Select [Programs].
- (3) Select [EpsonSVTools] - [EpsonSVTools].

### 1.3 Spectroscopic Camera Setup Procedure

When starting the software, the software will verify whether the Spectroscopic Camera is available at regular intervals.

If both USB 2.0 and USB 3.0 cables are used to connect the Spectroscopic Camera and the Spectroscopic Vision Controller, the Spectroscopic Camera connection procedure will commence. The following dialog box will appear while connecting.

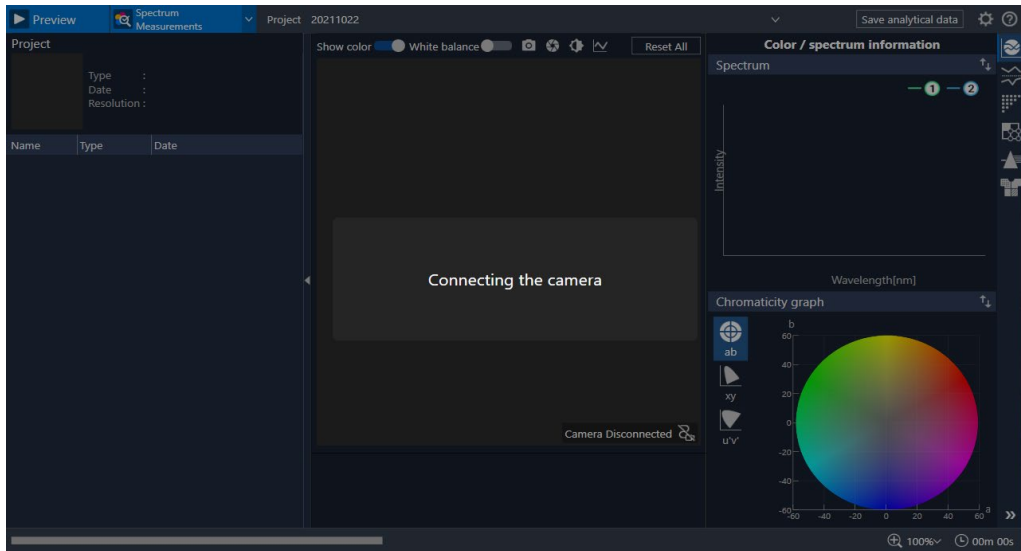

Once the setup procedure for the Spectroscopic Camera is complete, the “Camera/Disconnected” status will change to the “Camera/Connected” status as shown in the image below. The connection icon will also change at the same time.

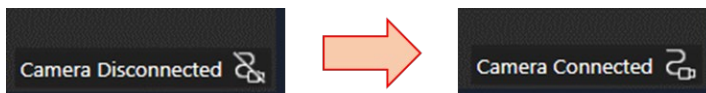

Once the setup procedure for the Spectroscopic Camera is complete, the Spectroscopic Camera’s model number and the serial number will appear on the title bar of the Main window.



## 2. Epson SV Tools GUI

This section describes the Epson SV Tools GUI.

- Summary : Data analysis\_Color / spectrum information
- Configuration : Data analysis\_Color inspection
- Preview : Data analysis\_Color difference distribution
- Spectroscopic measurement : Data analysis\_Color unevenness inspection
- Data browser : Data analysis\_Spectrum distinction
- Search window : Data analysis\_Fabric inspection

### 2.1 Summary

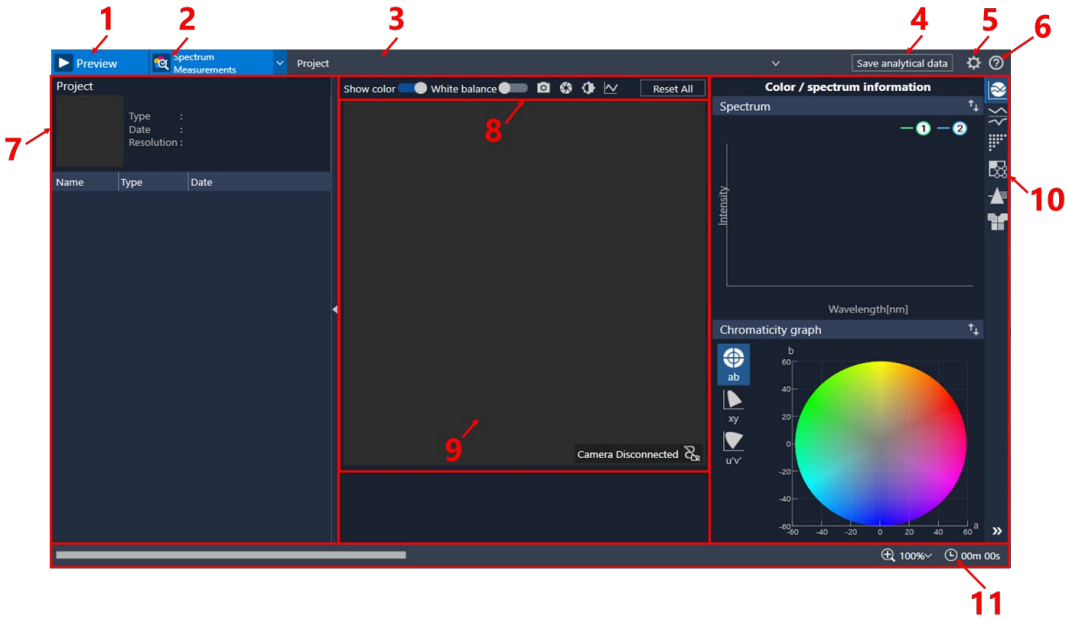

- 1 Start/stop preview button
- 2 Measurement for spectrum/Measurement for white balance button
- 3 Project name
- 4 Save analytical data button
- 5 Configuration button
- 6 Help button
- 7 Data browser
- 8 Preview settings
- 9 Preview screen
- 10 Data analysis results screen
- 11 Status bar

## 2.2 Configuration

You can configure spectrum measurement and analysis settings in the [Settings] window.

Click the <Configuration> icon  on the Main window to open the [Settings] window.

Note that the Main window cannot be used while the [Settings] window is displayed. Close the [Settings] window to reactivate the Main window.

Settings changes are saved, and will be applied the next time the software is started.

The [Settings] window and individual settings are as follows.

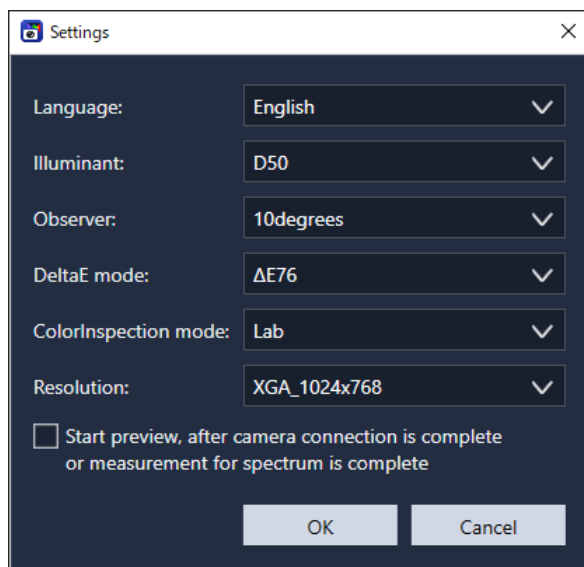

| Item        | Description   |
|-------------|---|
| Language    | Language settings<br>Default : If the OS language is Japanese: Japanese<br>If the OS language is English: English<br>If the OS language is Simplified Chinese: Simplified Chinese<br>If the OS language is Traditional Chinese: Traditional Chinese<br>If the OS is in another language: English<br>Language types : Japanese, English, Simplified Chinese, Traditional Chinese |
| Illuminant  | Light source settings to calculate the tristimulus values<br>Default : D50<br>Light source types: A, C, D50, D55, D65, D75, TL84, CWF   |
| Observer    | Color-matching function settings to calculate the tristimulus values<br>Default : 10degrees<br>Color-matching function types : 2degrees, 10degrees  |
| DeltaE mode | Color difference formula settings<br>Default : $\Delta E76$<br>Color difference formula types : $\Delta E76$ , $\Delta E94$ , $\Delta E00$ , $\Delta Ecmc$  |

|                      |  |
|----------------------|--|
| ColorInspection mode | Data analysis_Color inspection judgment mode settings<br>Default : Lab-determined color difference<br>Judgment types : Lab-determined color difference, determined by spectral shape |
| Resolution           | Resolution settings for the Spectroscopic Camera<br>Default : XGA<br>Types : QVGA_320×240, VGA_640×480, XGA_1024×768   |
| Preview mode         | This sets whether to automatically display a preview after the camera is configured for use, and measurement for spectrum is complete<br>Default : OFF                               |

## 2.3 Preview

You can configure settings for preview images displayed when using the Spectroscopic Camera. These settings also apply when loading measurement data.

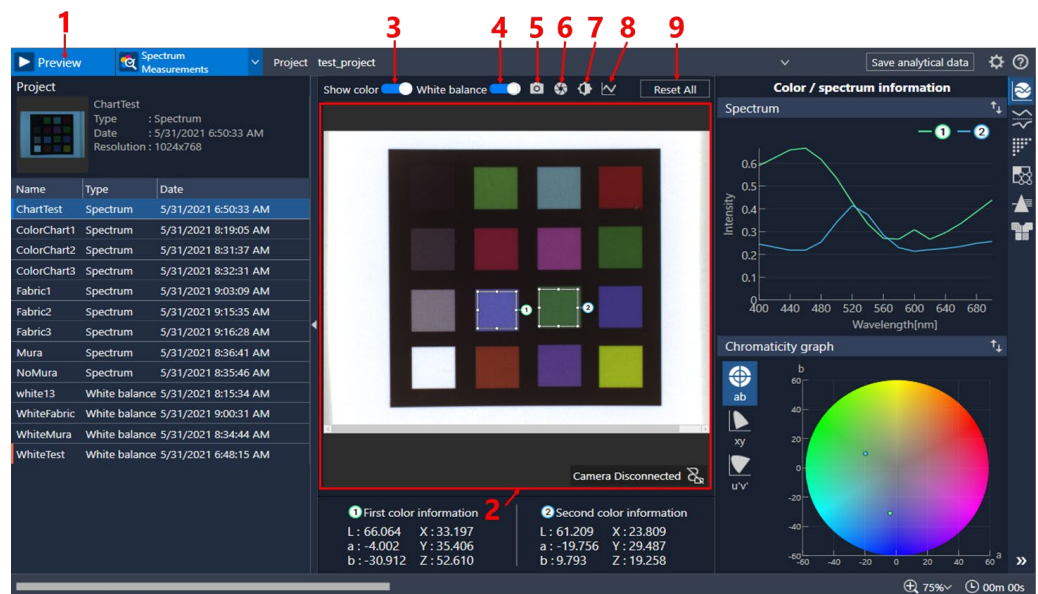

- 1 Preview button : Use this button when using the Spectroscopic Camera to start or stop a preview of the Spectroscopic Camera image.
- 2 Preview image : When using the Spectroscopic Camera, the image captured is displayed here in real-time. When loading measurement data, an RGB image of the measurement data is loaded.
- 3 Show color : Switches between displaying a color or monochrome preview image.  
 Show color ON : Displays a composite color image of B = 420 nm, G = 540 nm, R = 660 nm spectroscopic images.  
 Show color OFF : Displays a single configured spectroscopic image as a monochrome image.
- 4 White balance setting : Switches between turning white balance on and off for the preview image.

- ON : Displays a standardized color image that has been balanced against a measured white image. (Only applies when [Show color] is set to “ON”.)
- OFF : Displays the captured image as is.
- 5 Snapshot : A function used to capture the preview image for output. Captured image data is saved to the following folder. <D:\EpsonSVTools\Results\Snapshots>
- 6 Exposure time : Set the exposure time of the Spectroscopic Camera using the track bar. The longer the exposure time, the brighter the captured image will be. The exposure time is set in 0.001 second increments from 0.001 seconds to 1 second.
- 7 Gain : Set Spectroscopic Camera gain using the track bar, or by direct input. While increasing the gain will make the captured image brighter, it will also add noise to the image. The gain is set in increments of 1 from 0 to 255.
- 8 Wavelength : Set the spectroscopic wavelength filtered in the Spectroscopic Camera using the track bar. The wavelength is set in 20 nm increments within the 400 nm to 700 nm range.
- 9 Reset parameters : Resets current exposure time, gain, and wavelength settings to their default settings. Exposure time = 0.001 seconds, gain = 0, wavelength = 600 nm

## 2.4 Measurement

There are two types of measurements available - measurement for spectrum and measurement for white balance. You can select which type of measurement to use from the combo box drop-down list.

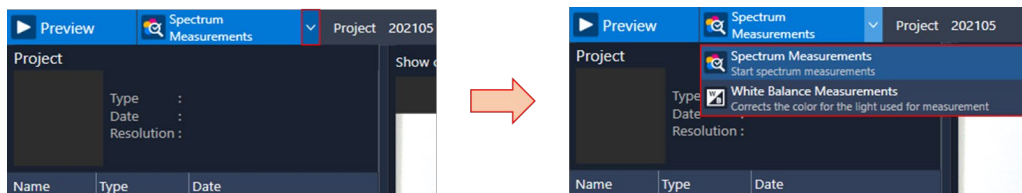

- Measurement for spectrum : This mode is used for spectroscopic measurements of measured workpieces. Spectral image data is captured in 20 nm intervals within a measurement wavelength range of 400 nm to 700 nm. Images are captured at the camera resolution set by the resolution setting.

Measurement for white balance : This mode is used to measure spectroscopic image data for white balancing.

This measures objects that are completely white across their entire surface area, such as white tiles or white paper. Spectral image data is captured in 20 nm intervals within a measurement wavelength range of 400 nm to 700 nm. Images are captured at a maximum resolution of (XGA\_1024×768).

## 2.5 Status Bar

This section describes the icons and functions on the status bar.

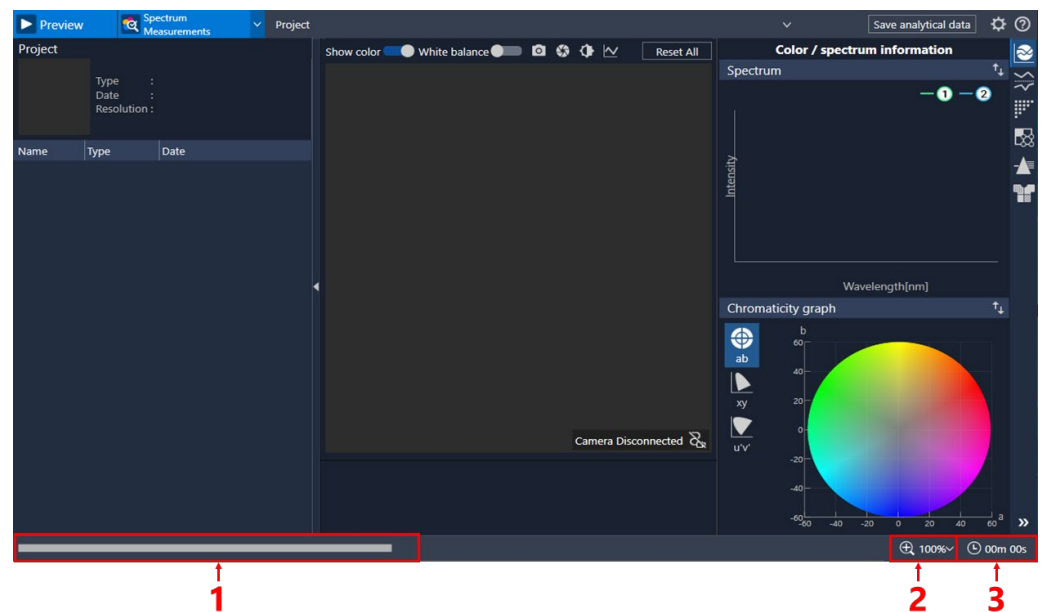

- |                      |  |
|----------------------|--|
| 1 Progress bar       | : Displays the progress of measurement for spectrum or measurement for white balance.  |
| 2 Preview image size | : Enlarge and shrink the size of the preview image.<br>There are nine image magnification settings to choose from: 50%, 75%, 100%, 150%, 200%, 250%, 300%, 400%, and 800%. |
| 3 Time               | : Displays the duration of measurement for spectrum or measurement for white balance.  |

## 2.6 Help Button

Click the Help button to display the PDF manual for the language you have set.

## 2.7 Data Browser

This section describes the icons and functions on the GUI used in the data browser.

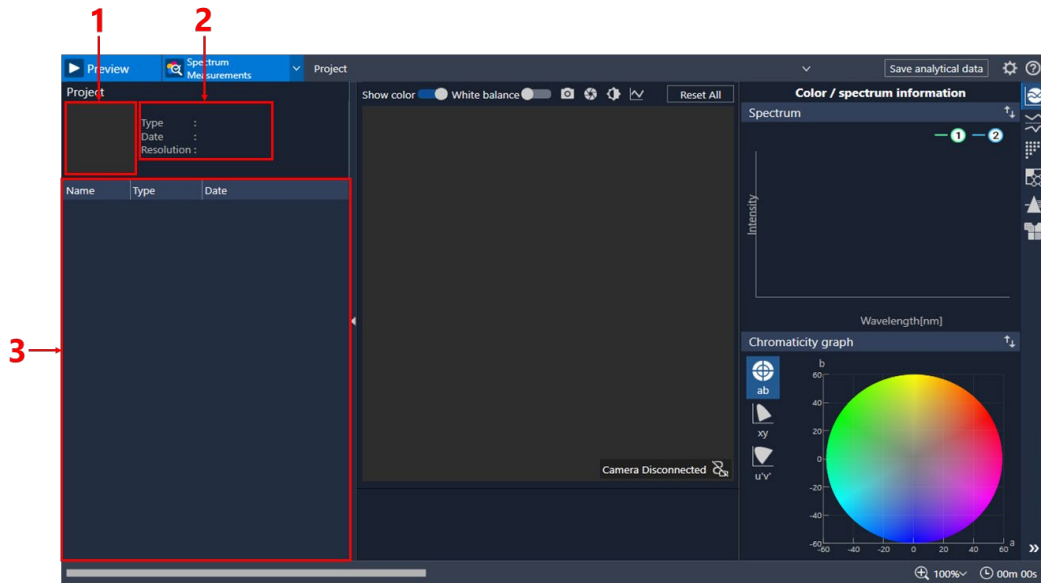

- 1 Data RGB image : When data is selected from the data list, an RGB image of the selected measurement data will appear.
- 2 Data information : When data is selected from the data list, information on the selected measurement data (data name, type, date, resolution) will appear.
- 3 Data list : When a project is selected, this list will display the results of measurement for spectrum, or measurement for white balance.  
The name, type, and date of the results will appear in the list. Right click the data when selected to display a menu to delete the data, change the data name, or delete the project.



## 2.8 Data Analysis\_Color / Spectrum Information

This section describes the icons and functions on the GUI used for this analysis.

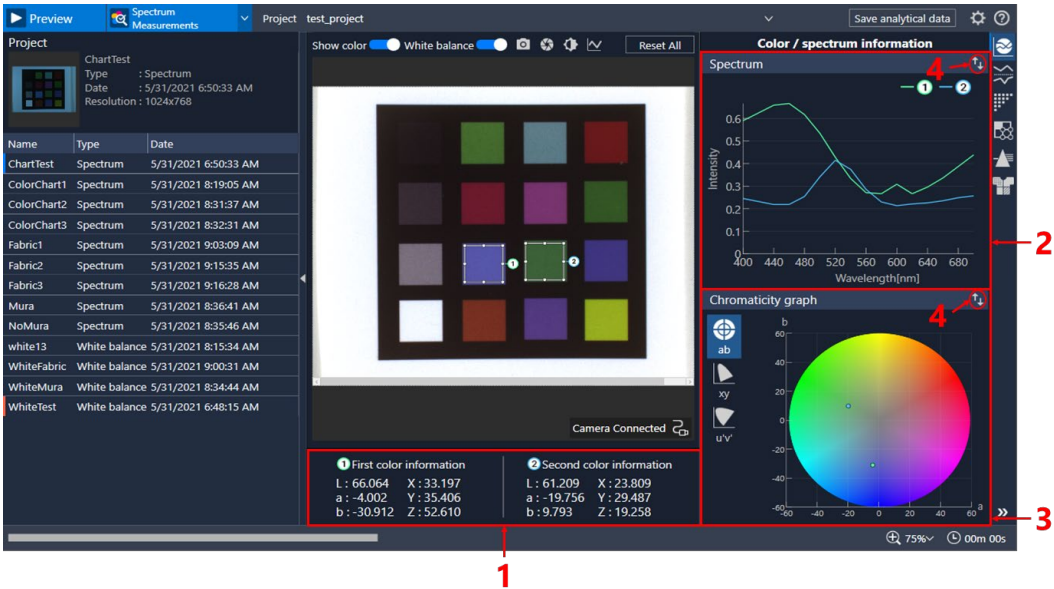

1 Color information : Displays color information for the 1 green search window and the 2 blue search window. The color information displayed will change depending on the chromaticity graph selected.

- : Displays the Lab.
- : Displays the xy values.
- : Displays the u'v' values.

2 Spectral graph : Displays the averaged spectrum in the search window. 1 Green search window results are plotted on the graph in green. 2 Blue search window results are plotted on the graph in blue.

3 Chromaticity graph : Displays a graph that plots 1 green search window and 2 blue search window color information on a color space. The color space displayed will also change depending on the chromaticity graph selected.

4 Change graph : Changes the position of the spectral graph and the chromaticity graph.

## 2.9 Data Analysis\_Color Inspection

This section describes the icons and functions on the GUI used for this analysis.

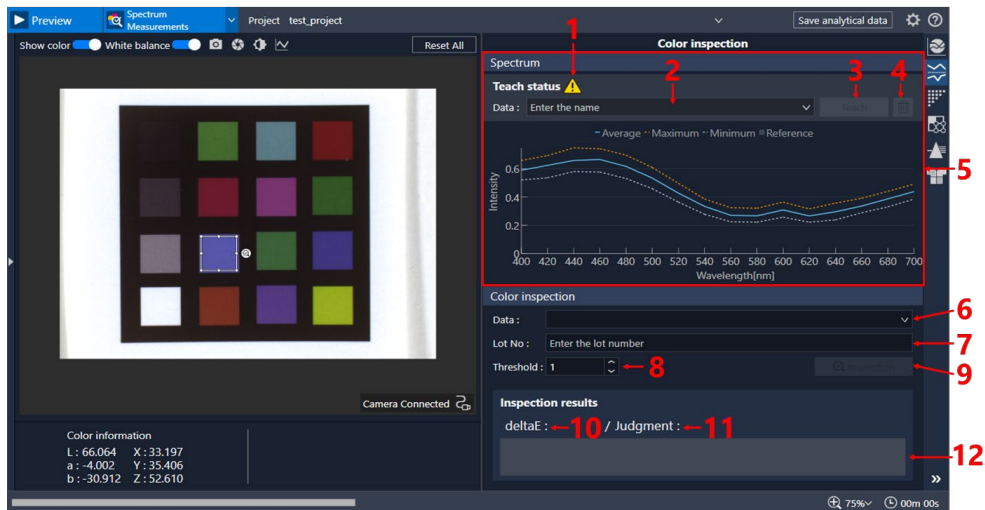

- 1 Warning : Displays when data is unregistered.
- 2 Data registration name : Enter the name of the data to register.
- 3 Register : Click this button to register data.  
Registers the average color information and spectroscopic information in the search window displayed.
- 4 Delete : Delete data selected from the list 2.
- 5 Spectral graph : Plots the average/maximum/minimum spectrum data in the search window, and the average spectrum data selected in “6. Data”.
- 6 Data : Select the inspection reference from registered data.
- 7 Lot No. : Enter the lot number for inspection.
- 8 Threshold : Set the color difference threshold between the inspection reference and the inspection target.
- 9 Inspection : Click this button to perform a color inspection.  
The inspection target will be the average color information of the area specified in the search window. Once the color inspection ends, the color difference results, registered data judgments, and overall results will be output.
- 10 Color difference results : Outputs the color difference between the registered data and the inspection target.
- 11 Registered data judgment: The color information of the inspection target is compared against all registered data to output the matching data name. If the matching data is not found, the “Unknown” status will be output.

12 Overall results : This will output “PASS” if the color difference results are under the threshold, and the color information of the registered data and the inspection target is the same. If these conditions are not met, this will output “FAIL”.

## 2.10 Data Analysis\_Color Difference Distribution

This section describes the icons and functions on the GUI used for this analysis.

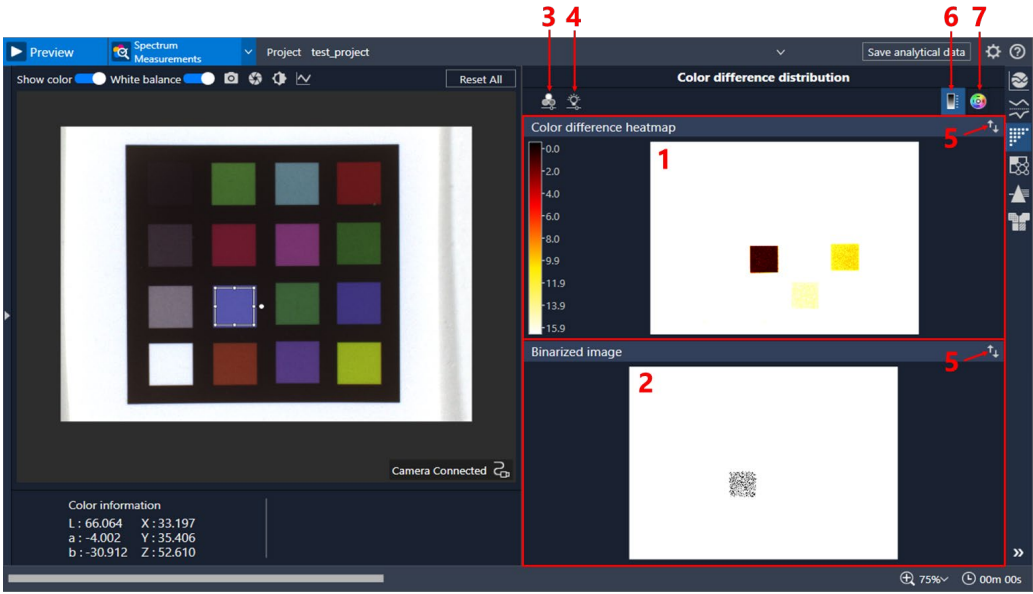

1 Color difference heatmap : Displays a color image that is color-coded based on the size of the color difference calculated in pixels. The color difference corresponding to the colors in the color difference heatmap can be displayed by 6 Display color difference threshold.

2 Binarized image : Displays a monochrome image rendered using white color below the threshold, and black color at or above the threshold, based on the per pixel color difference and threshold value.

3 Color difference range setting : Use this to change the color assignment for the size of the color difference in a color difference heatmap. Click this icon to display a track bar. Move the track bar to change the color assignment for the size of the color difference.

4 Color difference threshold : Use this to set the color difference threshold for a binarized image. Click this icon to display a track bar. Move the track bar to change the threshold.

5 Change image : Changes the position of the color difference heatmap and the binarized image. This is used to compare preview images and analysis images.

6 Display color difference threshold : Displays color difference values corresponding to the colors in the color difference heatmap.

7 Reference Lab : Set the reference Lab to calculate color difference. Lab settings can be configured in either of the following ways.

- Specifying the value using the search window
- Direct input

## 2.11 Data Analysis\_Color Unevenness Inspection

This section describes the icons and functions on the GUI used for this analysis.

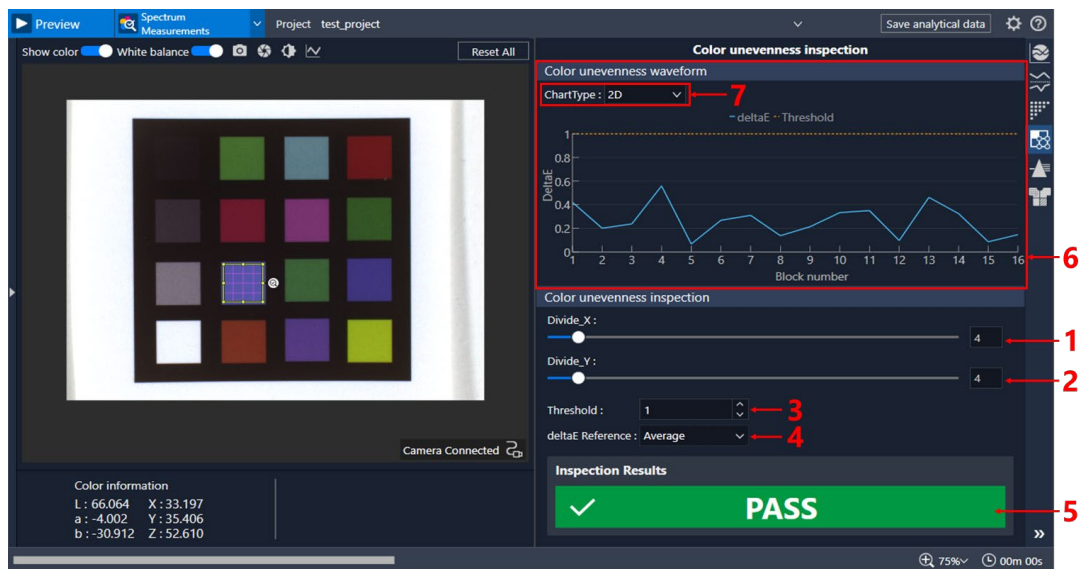

- 1 Divide\_X : Sets the number of divisions in the width direction of the search window.  
Number of divisions: 1 to 50
- 2 Divide\_Y : Sets the number of divisions in the height direction of the search window.  
Number of divisions: 1 to 50
- 3 Threshold : Sets the threshold for determining color differences in a color unevenness inspection.  
Setting range: 1 to 100
- 4 deltaE Reference : Configures reference Lab settings to calculate color difference.  
Select either the overall average of the reference color, or a split block. The location of the block selected will appear in a yellow frame. The overall average is used by default.
- 5 Result : Outputs the results of the color unevenness inspection.  
If the color difference of each block is below the threshold, the “PASS” status will appear. If the color difference is at or above the threshold, the “FAIL” status will appear. Blocks above the threshold will appear in an orange frame.

## 6 Color unevenness waveform graph

: Outputs the color difference of each block in graph form. Block numbers are assigned horizontally with 1 being the upper left. If the number moves up to the upper right, it moves to the block below the upper left. The final block number will be on the lower right.

## 7 Change graph

: Sets whether to display the color unevenness waveform graph in 2D or 3D.

## 2.12 Data Analysis\_Spectrum Distinction

This section describes the icons and functions on the GUI used for this analysis.

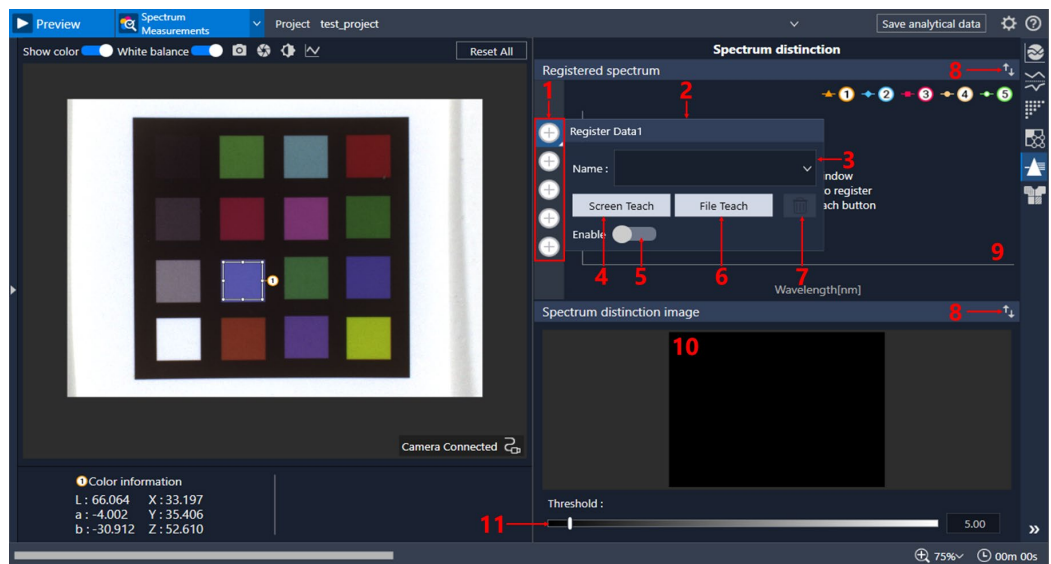

## 1 Teach data 1 to 5

: The data registration icons.

Click an icon to display the data registration panel. Tags on the search window may also change depending on the icon positions.

## 2 Data registration panel

: Places data registration options.

## 3 Data registration name

: Enter the name of the data to be registered.

## 4 Screen Teach

: Registers data from a range specified in the search window. This also outputs registered data to be used with File Teach.

## 5 Identification target settings

: Sets whether to identify the registered data.

## 6 File Teach

: Loads and registered data generated with Screen Teach.

## 7 Delete

: Deletes the registered data.

## 8 Change image

: Changes the position of the spectral graph and the spectrum distinction image.

## 9 Spectral graph

: Plots the average/maximum/minimum spectrum of the registered data.

- 10 Spectrum distinction image : Outputs a spectrum distinction image as a color image based on the Mahalanobis distance for the registered data.
- 11 Threshold setting : Sets the spectral matching threshold.  
Change the position of the track bar to set the threshold.

## 2.13 Data Analysis\_Fabric Inspection

This section describes the icons and functions on the GUI used for this analysis.

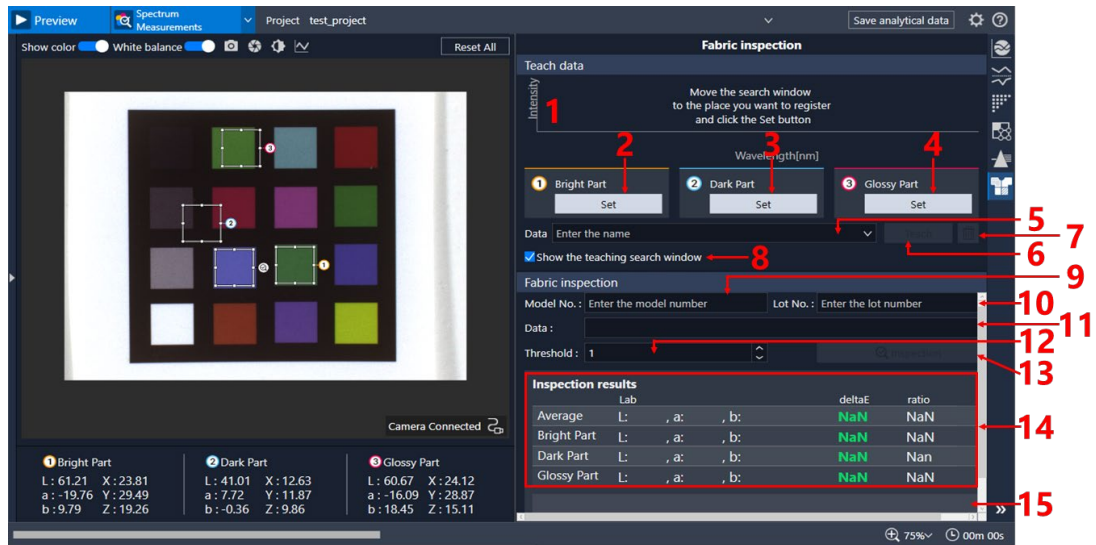

- 1 Spectral graph : Plots the average spectrum when registering Glossy Part, Bright Part, and Dark Part data. Click the legend to show/hide the graph.
- 2 Set1\_Bright Part : Specify the registering position in the search window 1 to set Bright Part data.
- 3 Set2\_Dark Part : Specify the registering position in the search window 2 to set Dark Part data.
- 4 Set3\_Glossy Part : Specify the registering position in the search window 3 to set Glossy Part data.
- 5 Color No (for registering) : Enter the name to register.
- 6 Teach : Calculate and save the three data parts for learning - Glossy Part, Bright Part, and Dark Part data.
- 7 Delete : Deletes the registered data selected in the list.
- 8 Change display : Show/hide the registration search windows 1 to 3. It is recommended that the registration search windows are displayed when registering data, and hidden during inspection.
- 9 Model No : Enter the name of the model for inspection.
- 10 Lot No : Enter the lot number for inspection.
- 11 Color No (for inspection) : Select the registered data.

- 12 Threshold : Set the inspection threshold for color differences between the inspection target and the registered data.
- 13 Inspection : Extracts the Glossy Part, Bright Part, and Dark Part within the search window based on registered data, and then calculates the average Lab. In addition, this also calculates the color difference of the registered data, and outputs the color difference to the inspection results.
- 14 Inspection results (data) : Displays the Lab,  $\Delta E$ , and Ratio results for the overall average, Glossy Part, Bright Part, and the Dark Part. If the color difference exceeds the threshold, the results text will appear orange. If the color difference is below the threshold, this will appear green.
- 15 Result : Displays PASS/FAIL judgment results.  
A PASS judgment is given if the color difference for all four data types - the overall average, Glossy Part, Bright Part, and Dark Part - are below the threshold. Under all other circumstances, a FAIL judgment will be given.

## 3. Preview Image Settings

This section describes the configuration of Spectroscopic Camera preview images.

- Color display
- Displaying a spectroscopic image and selecting wavelength
- Exposure time settings
- Gain settings
- Capturing preview images

### 3.1 Color Display

Spectroscopic cameras can be changed to any wavelength. A color image can be obtained by capturing the wavelengths (three bands) corresponding to the three primary colors of light (RGB) and assigning each to RGB. After capturing three images of different wavelengths, these are brought together to form a color image. As such, it takes time to update the image display, exposure time, and gain for color images compared to a spectroscopic image (monochrome). The operating procedure is described below.

STEP1.

Click the <Preview> button.

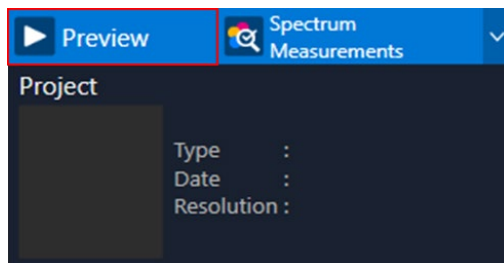

STEP2.

After the preview begins, click the color display ON/OFF button to turn it from “OFF” to “ON”. This will display the preview image in color.

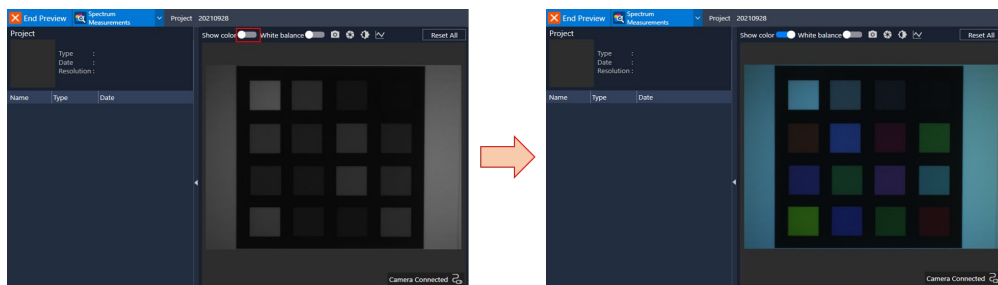



## 3.2 Displaying a Spectral Image and Selecting Wavelength

As a Spectroscopic Camera can be set to any wavelength, you can obtain a spectroscopic image (monochrome image) at any wavelength. The operating procedure is described below.

STEP1.

Click the <Preview> button.

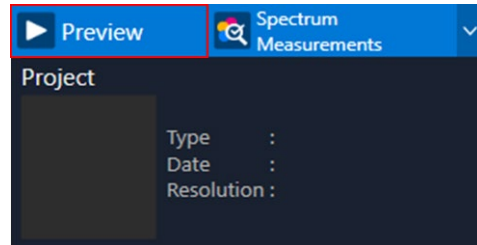

STEP2.

After the preview begins, click the color display ON/OFF button to turn it from “ON” to “OFF”. This will display the preview image in monochrome.

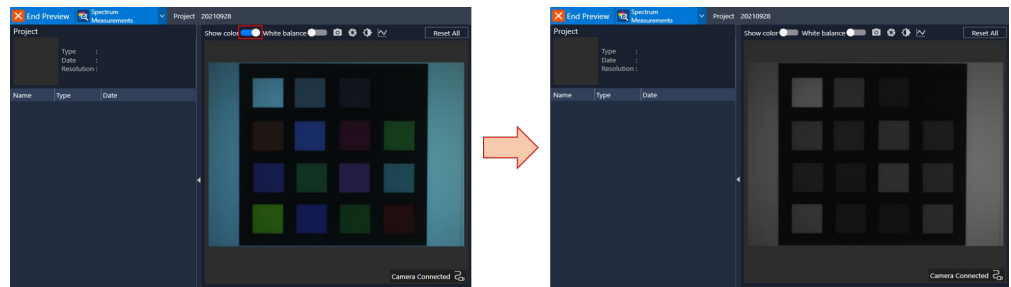

STEP3.

Click the wavelength icon 1 to display the change wavelength panel 2.

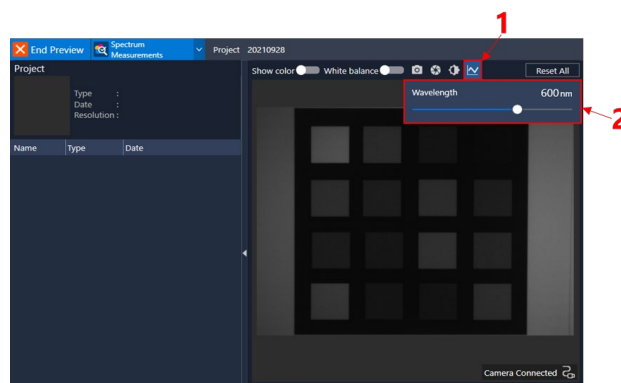

STEP4.

Move the track bar on the change wavelength panel to set the wavelength.

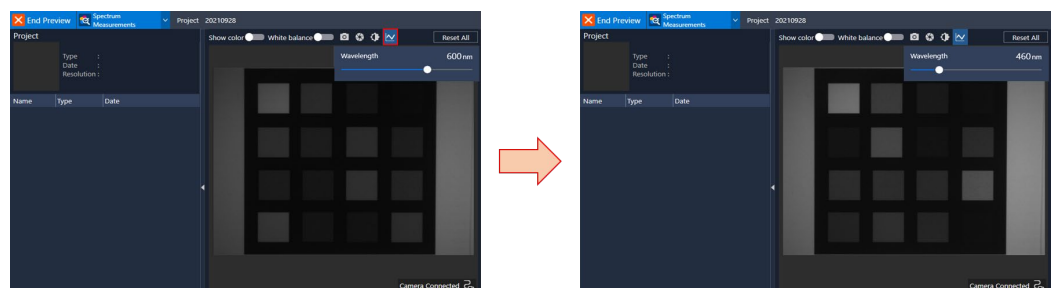

### 3.3 Exposure Time Settings

This section describes how to set the camera exposure time. The exposure time set here only applies to previews. During a measurement for spectrum, or a measurement for white balance, the exposure time is automatically adjusted to a brightness that does not cause halation in the image data. The operating procedure is described below.

STEP1.

Click the <Preview> button.

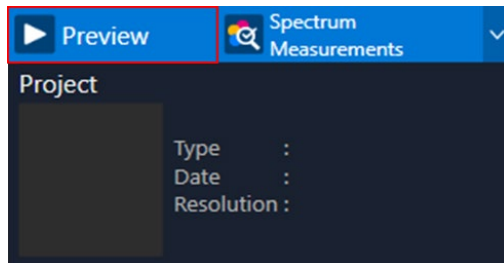

STEP2.

Click the exposure time icon 1 to display the change exposure time panel 2.

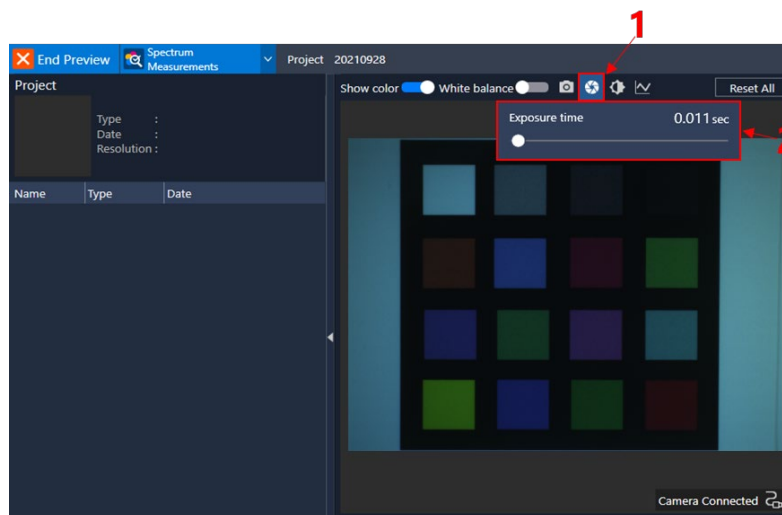

STEP3.

Move the track bar on the change exposure time panel to set the exposure time. While increasing the exposure time will result in a brighter preview image, this will also delay updates in the preview image, making it increasingly difficult to determine measurement positions. If this occurs, increase the light intensity or the gain to obtain a bright image with a short exposure time.

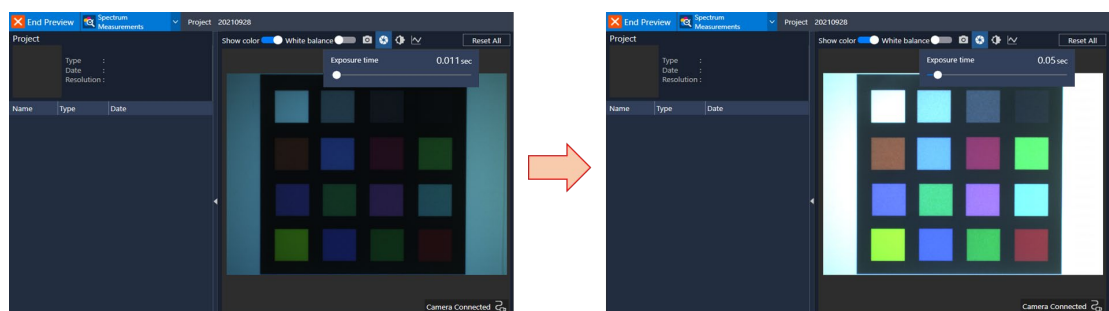

## 3.4 Gain Settings

This section describes how to set the camera gain. The gain setting configured here only applies to previews. A predetermined value is used for measurement for spectrum and measurement for white balance, and this setting will not be applied. The operating procedure is described below.

STEP1.

Click the <Preview> button.

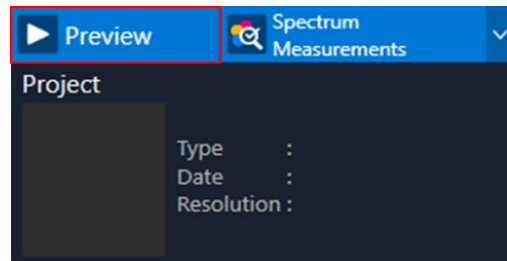

STEP2.

Click the gain icon 1 to display the change gain panel 2.

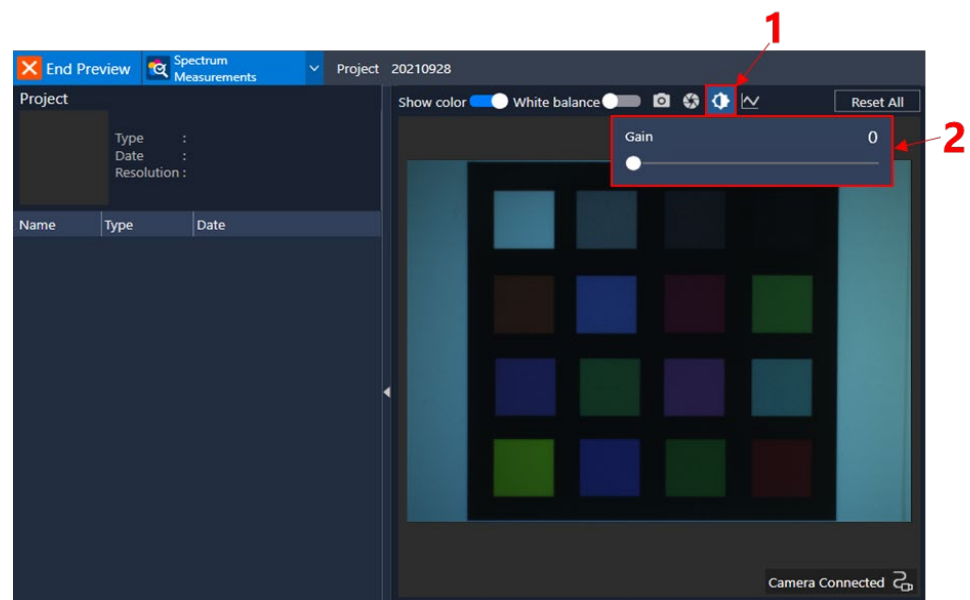

STEP3.

Move the track bar on the change gain panel to set the gain. Increase the gain to make the preview image brighter. However, increasing the gain too much will increase the amount of noise in the preview image, resulting in an unclear image.

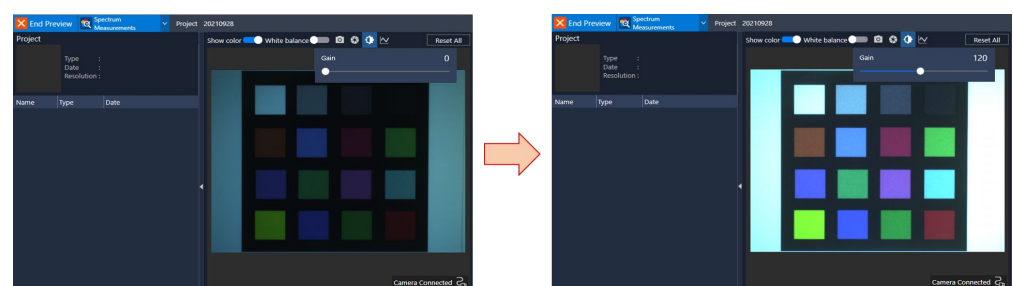

### 3.5 Capturing Preview Images

This section describes how to save the preview image shown in any image format (tif, jpeg, bmp, and png).

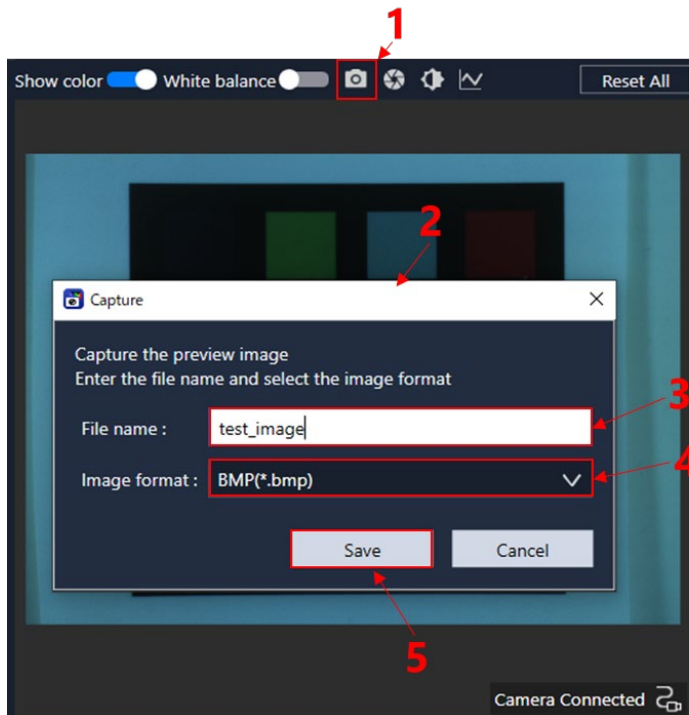

- (1) Click the snapshot icon 1.
- (2) The [Capture] dialog box 2 is displayed.
- (3) Select the file name to save. 3
- (4) Select the image format. 4
- (5) Click the <Save> button 5.  
The image data will be saved.

Image data is saved to the following folder.

<D:\EpsonSVTools\Results\SnapShots>

## 4. Measurement

This section describes how to capture a spectroscopic image using a Spectroscopic Camera, and then using it to perform a measurement for spectrum.

- Project settings
- Measurement
  - Measurement for white balance
  - Measurement for spectrum

### 4.1 Project Settings

Before performing a measurement for spectrum or a measurement for white balance, set the project name. Measurement data will be saved in relation to the project set. To create a new project, enter the name of the new project. To use an existing project, select the project from the list.

Create new project

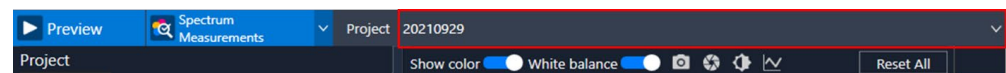

Select existing project

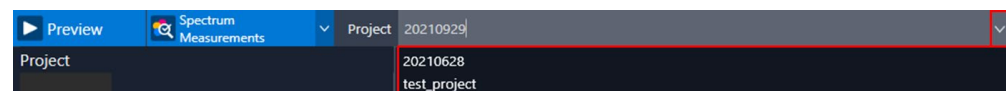

### 4.2 Measurement

There are two types of measurements available - measurement for spectrum and measurement for white balance.

A standalone measurement for spectrum is performed if the measurement object is an LCD panel, LED, lighting, or another such light emitting body. A measurement for white balance is not required.

Both a measurement for spectrum and a measurement for white balance are required when seeing reflected color from printing materials, cosmetics, fabrics, or other such measurement objects.

Both a measurement for spectrum and a measurement for white balance are required when seeing the transparent color of a liquid. The measurement for white balance is required to smooth out the unevenness of light intensity, and to normalize reflection and transparency.

A measurement for white balance is applied at the following times.

- When changing the position or the type of lighting used
- When changing the light intensity, even if the light and light placements do not change
- When changing the type of lens, or the aperture attached to the Spectroscopic Camera
- When changing the distance between the Spectroscopic Camera and the measurement object (the working distance)

### 4.2.1 Measurement for White Balance

The procedure for the measurement for white balance is described below.

#### STEP1.

Start a Spectroscopic Camera preview, and place a white color reference for measuring white balance in front of the Spectroscopic Camera so that it fills the entire preview image area.

If the white color reference does not fill the entire preview image area, either change the lens, or alter the distance between the camera and the measurement object.

We recommend using the following objects as white color reference objects.

For reflective measurement: White plate

For transparent measurement: Backlight plate

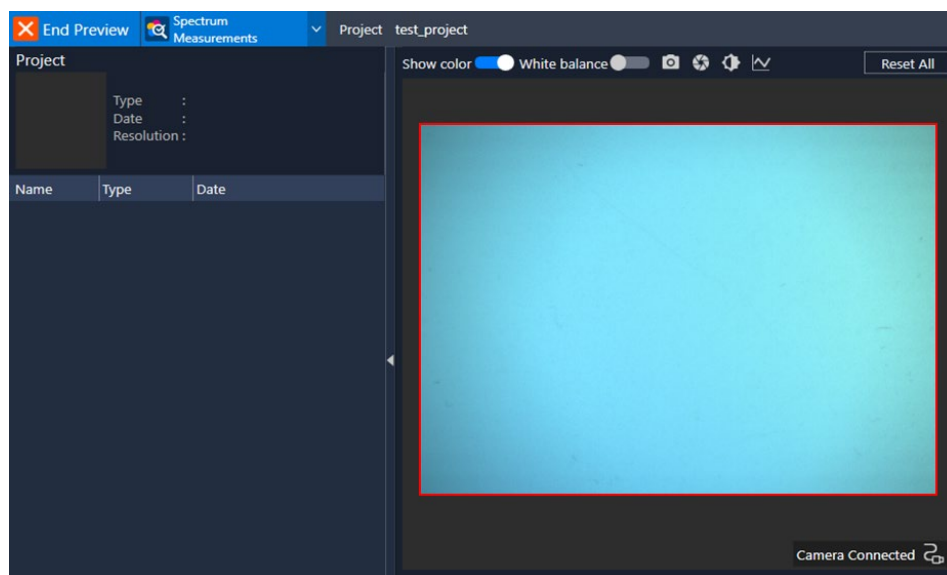

#### STEP2.

Change the measurement mode from “Measurement for spectrum” to “Measurement for white balance”.

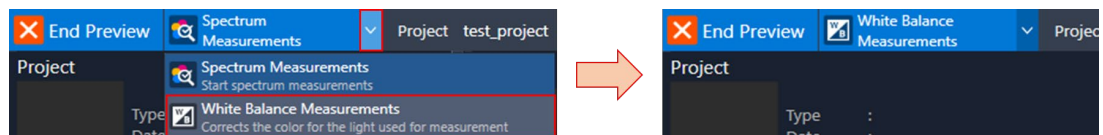

## STEP3.

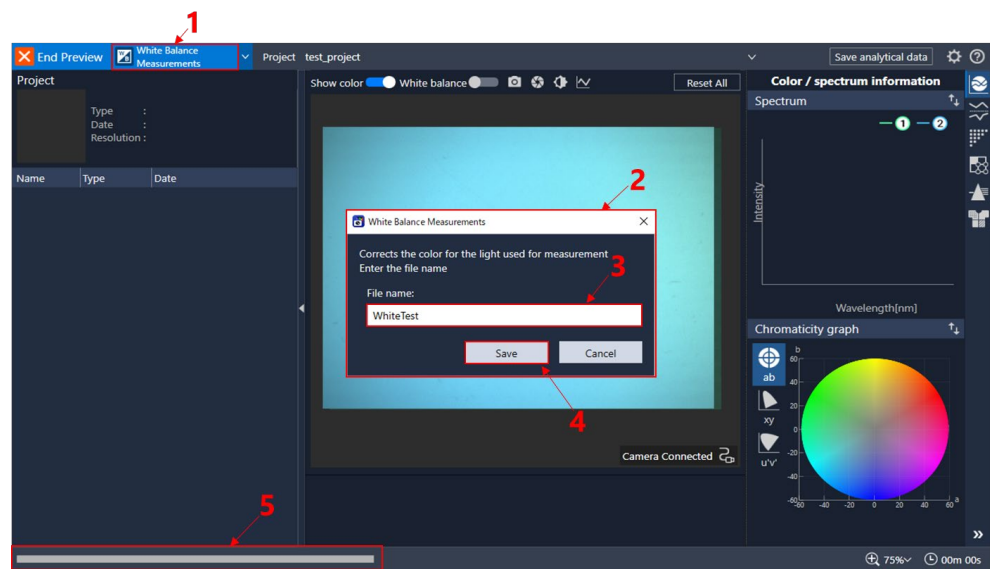

- (1) Click the <Measurement for white balance> button 1.
- (2) The [Measurement] dialog box 2 is displayed.  
You will be asked for the name to use for the saved data.
- (3) Enter the file name. 3
- (4) Click the <Save> button 4.  
The measurement for white balance will begin.
- (5) The current progress is shown on the progress bar on the status bar 5.

Once the measurement for white balance is complete, the measurement data is displayed in the data browser.

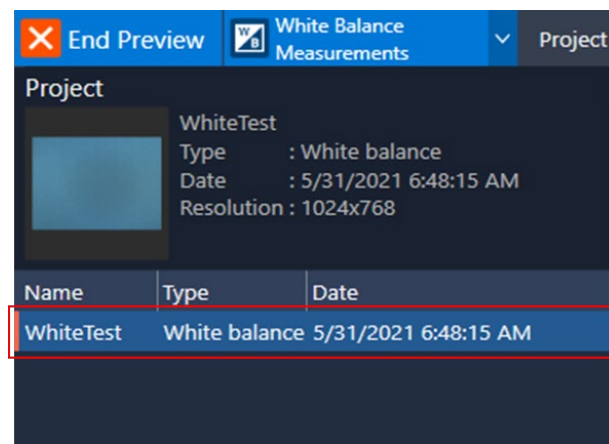

STEP4.

To apply the white balance, turn the white balance switch in the preview settings menu from “OFF” to “ON”. When the white balance setting is “ON”, a white balance will be applied when performing measurements for spectrum, or when loading measurement for spectrum data.

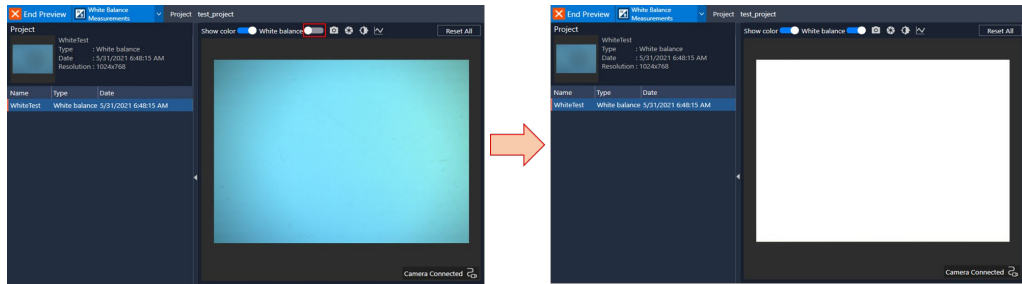

### 4.2.2 Measurement for Spectrum

This section describes the procedure for the measurement for spectrum.

STEP1.

Start a Spectroscopic Camera preview, and place the measurement object so that it fills the entire preview image area of the Spectroscopic Camera.

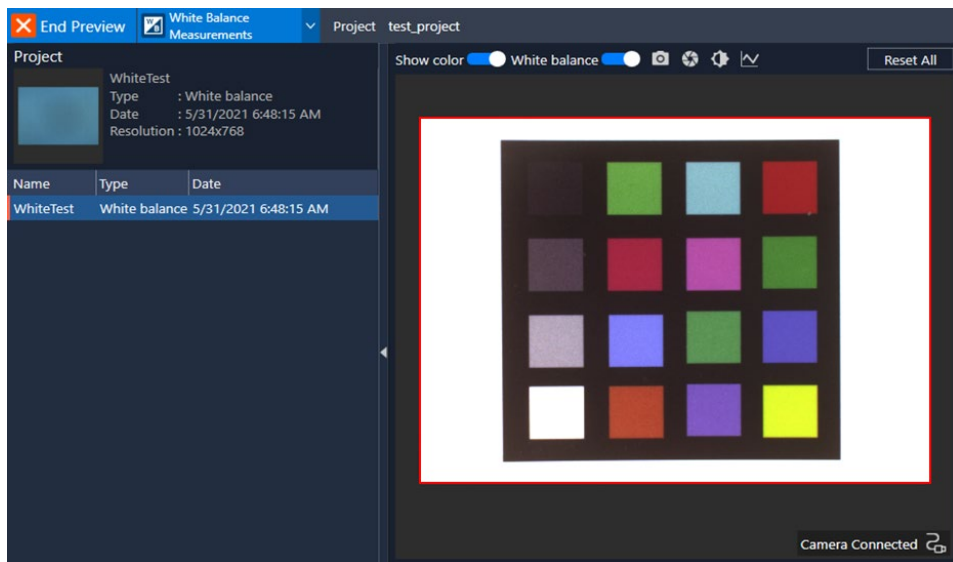

STEP2.

Change the measurement mode to “Measurement for spectrum”.

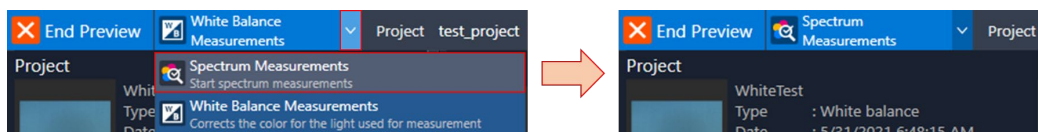



## STEP3.

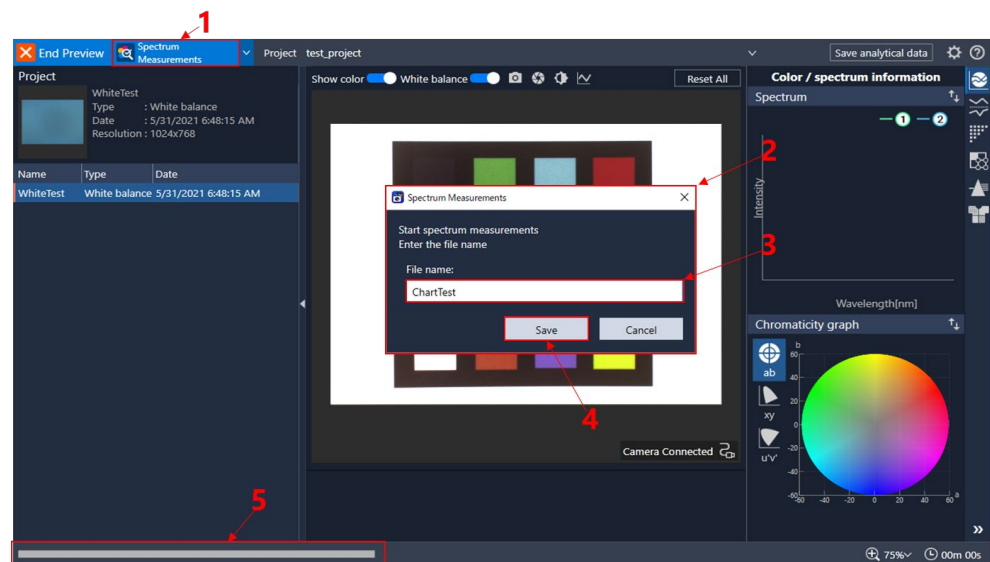

- (1) Click the <Measurement for spectrum> button 1.
- (2) The [Measurement] dialog box 2 is displayed.  
You will be asked for the name to use for the saved data.
- (3) Enter the file name. 3
- (4) Click the <Save> button 4.  
The measurement for spectrum will begin.
- (5) The current progress is shown on the progress bar on the status bar 5.

Once the measurement for spectrum is complete, the measurement data is displayed in the data browser.

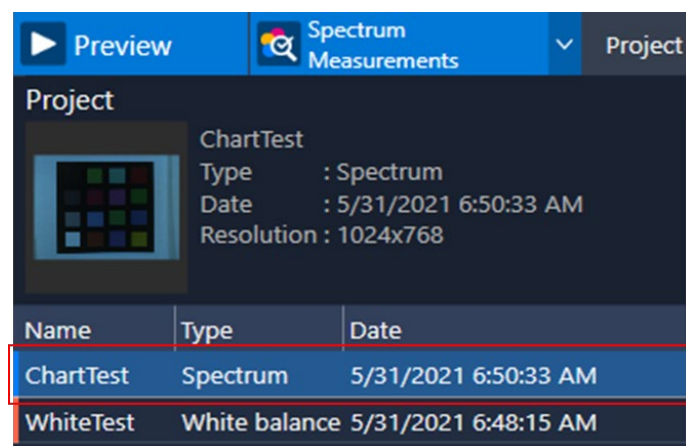

## 5. Data Browser

This section describes how to use measurement for spectrum and measurement for white balance data.

- Loading data
- Renaming data
- Deleting data
- Deleting projects

### 5.1 Loading Data

Double click a data name displayed in the data list in the data browser to load the corresponding data.

After loading white balance data, an orange mark will appear beside the name of the data loaded.

After loading measurement for spectrum data, a color or monochrome image of the measurement for spectrum data will appear in the Preview screen, and a blue mark will appear beside the name of the data loaded.

Case 1. Loading white balance data

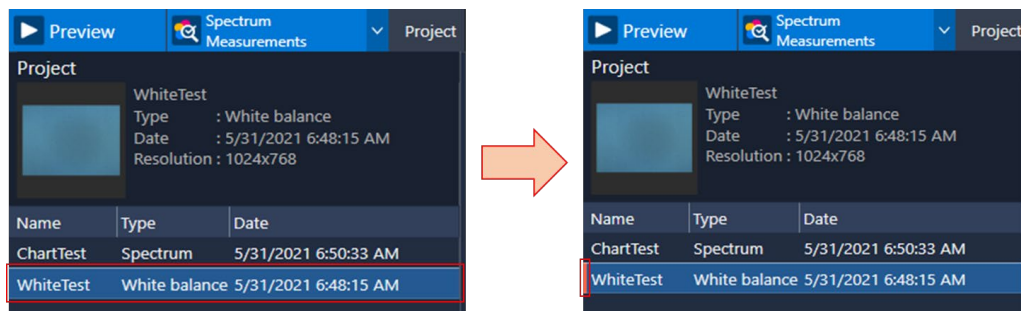

Case 2. Loading spectrum data

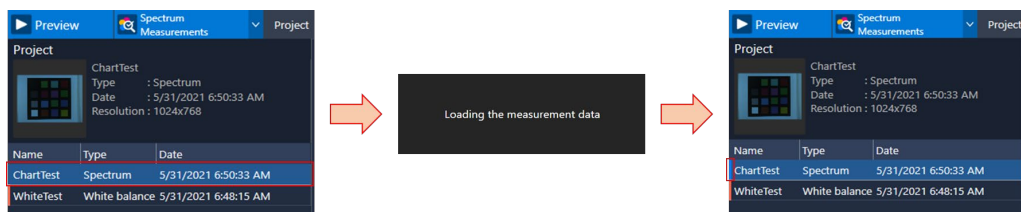

## 5.2 Renaming Data

This section describes the procedure for renaming data.

- (1) Select data from the data list, and then right click.  
A menu will appear.
- (2) Select [Rename], and then change the data name.

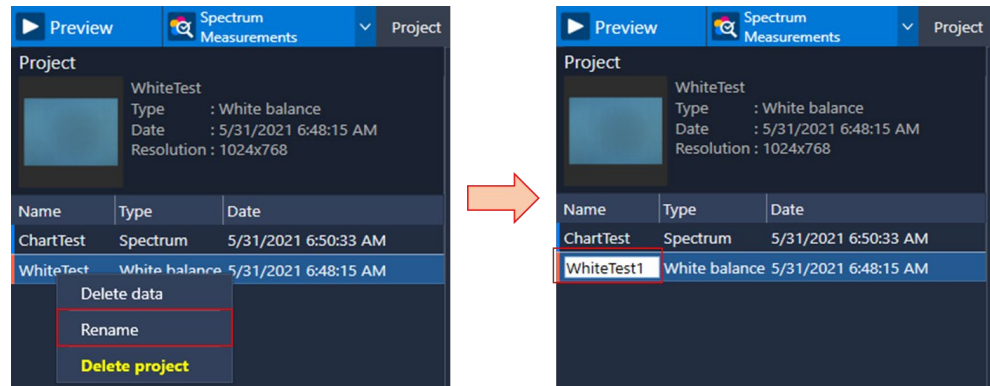

## 5.3 Deleting Data

This section describes the procedure for deleting data.

- (1) Select data from the data list, and then right click.  
A menu will appear.
- (2) Select [Delete data].
- (3) Click the <Yes> button.  
The selected data will be deleted.

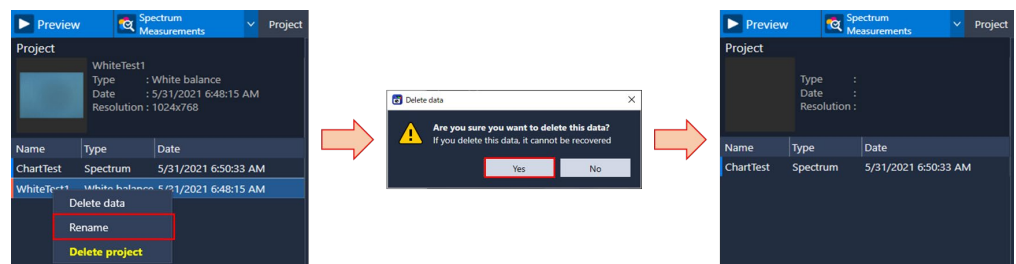

## 5.4 Deleting Projects

This section describes the procedure for deleting projects.

(1) Select data from the data list, and then right click.

A menu will appear.

(2) Select [Delete project].

(3) Click the <Yes> button.

The selected project will be deleted.

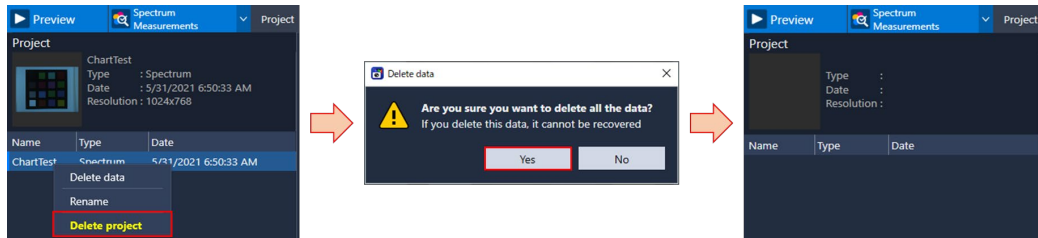

## 6. Search Window

This section describes the search window, which can be used to register data for analysis and specify the inspection area, among other actions.

An outline of the search window is provided in the figure below.















To change the size of the search window:

Drag  in the direction of the red arrows.

To move the search window:

Click and drag inside the search window frame.

Tag icons will change depending on the analysis.

- Spectral analysis   (two types of color extraction)
- Color inspection  (for registering data and inspections)
- Color difference distribution  (none)
- Color unevenness inspection  (for inspections)
- Spectrum distinction      (for registering data)
- Fabric inspection    (for registering data)  (for inspection)

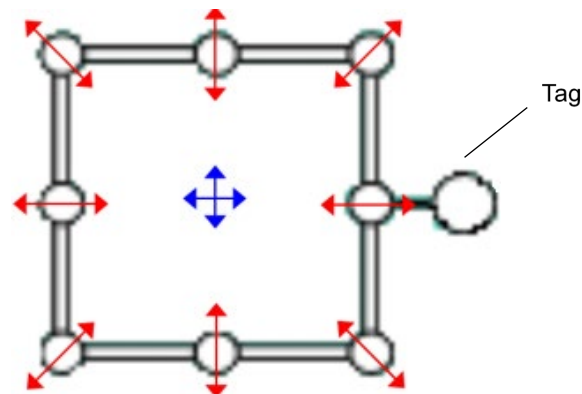

## 7. Data Analysis Functions

This section describes the data analysis functions.

- Color / spectrum information
- Color inspection
- Color difference distribution
- Color unevenness inspection
- Spectrum distinction
- Fabric inspection

### 7.1 Color / Spectrum Information

This function compares the color and spectral differences between two measurement objects on the screen for which a measurement for spectrum has been performed based on spectral information, or tristimulus values XYZ and Lab color information.

#### 7.1.1 Usage

Change the size and position of the search windows ① and ② to the position you want to compare.

The color information value averaged in the search windows, and the spectral and chromaticity graphs are displayed.

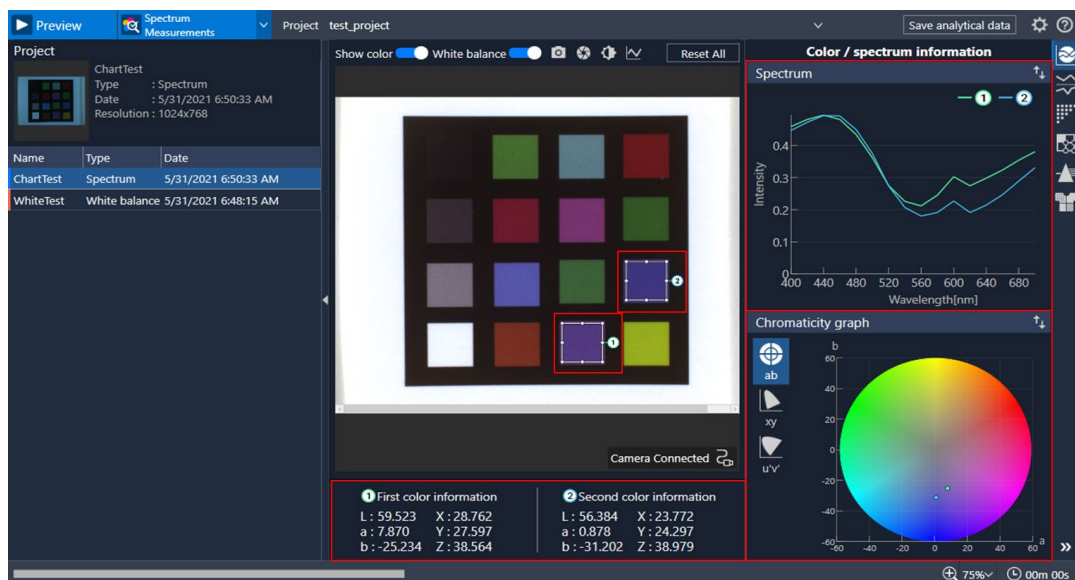

### 7.1.2 Chromaticity Graph

Select the type of chromaticity graph.

To select ab chromaticity coordinates:



To select xy chromaticity coordinates:

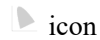

To select u'v' chromaticity coordinates:



Generally, ab chromaticity coordinates are used to evaluate the reflective color or transparent color of an object.

When evaluating a monitor, projector, LED, or other self-luminous objects, use the xy chromaticity coordinates or the u'v' chromaticity coordinates.

Case: Change the chromaticity graph (ab chromaticity coordinates -> xy chromaticity coordinates)

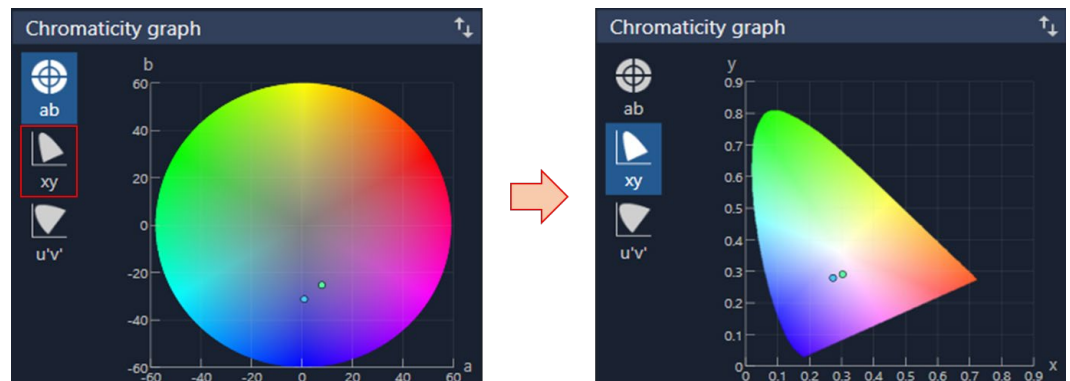

### 7.1.3 Save Analytical Data

To output spectral and color information data from search windows ① and ②, click

**Save analytical data**

Enter the data name and click the <Save> button to save the following data in json format.

The averaged spectrum within the search window (400 to 700 nm, 20 nm increments)

XYZ, Lab, xy, u'v'

Light source information, color-matching function, color difference formula, and the size and position of the search window

<D:\EpsonSVTools\Results\Projects\Name of created project\Name of measurement data>

Data name: ColorInfomation\_(Any string of 40 characters or less).json

Per-pixel spectrum information for search windows ① and ② is saved alongside search window information in json format.

① Data name: SpectrumPerPixel\_No1\_(Any string of 40 characters or less).json

② Data name: SpectrumPerPixel\_No2\_(Any string of 40 characters or less).json

## 7.2 Color Inspection

This function uses registered color information and threshold values to identify matches between colors subject to measurement and registered color information, and inspects whether these fall within the inspection threshold range. Color information must be registered in advance before using this function.

### 7.2.1 Data Registration

Change the size and position of the search window to place it over the area you want to register for measurement. Once placed, the average/maximum/minimum spectrum data in the search window will be displayed in the spectral graph. If the average spectrum deviates greatly from the maximum and minimum spectrum values, the extraction window has not been placed properly over the measurement object. Check the position and size of the extraction window.

Case 1. Placed over the wrong area

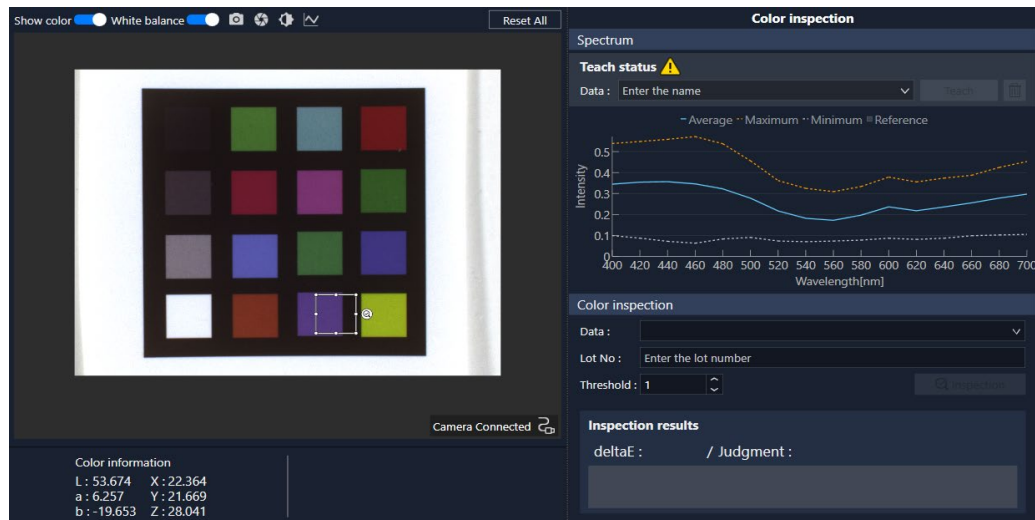

Case 2. Placed correctly

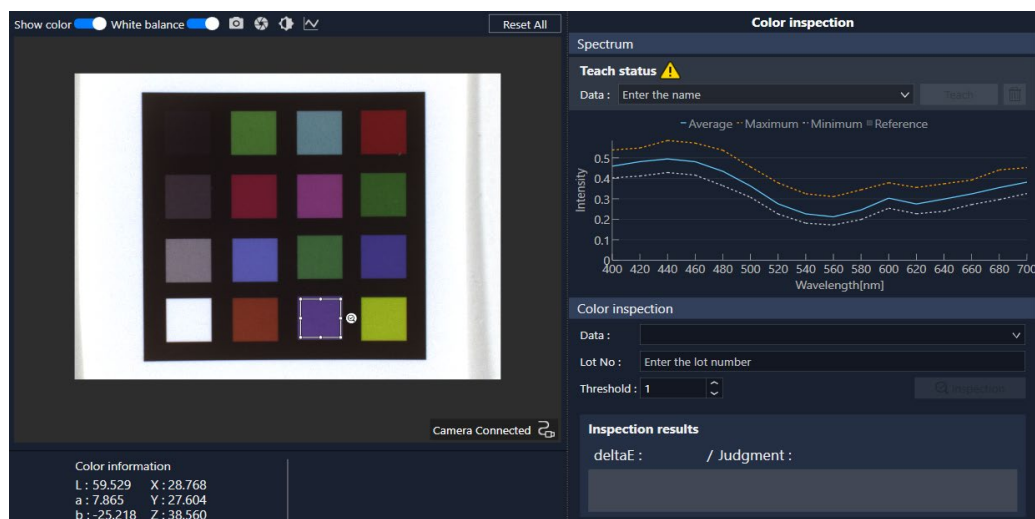



If the extraction window has been properly placed over the measurement target area in the spectral graph, proceed to the next step to register the data.



- (1) In the [Data] field 1, enter the name of the data you want to register.
- (2) Click the <Teach> button 2.

#### Points to be aware of when registering data:

There may be differences particular to individual Spectroscopic Cameras, lenses, and lighting. When replacing the camera, you will need to complete the data registration process again. In addition, the following aspects of the overall measurement system may impact the measurement results.

- The type of lighting and lens used
- The positional relationship between the lighting, Spectroscopic Camera, and the measurement object
- Individual differences in the lighting, Spectroscopic Camera, and lens
- The brightness of the lighting, and the lens focus and aperture condition

Once an inspection reference standard has been established by measuring reference samples and data registration, do not alter these elements of the measurement system. If changed, you will need to reset the inspection reference standard again beginning with measuring the white balance.

#### NOTE



When purchasing multiple systems, you will need to redo the data registration process in the same way as when replacing the hardware.

## 7.2.2 Delete Registered Data

This section describes the procedure for deleting registered data.

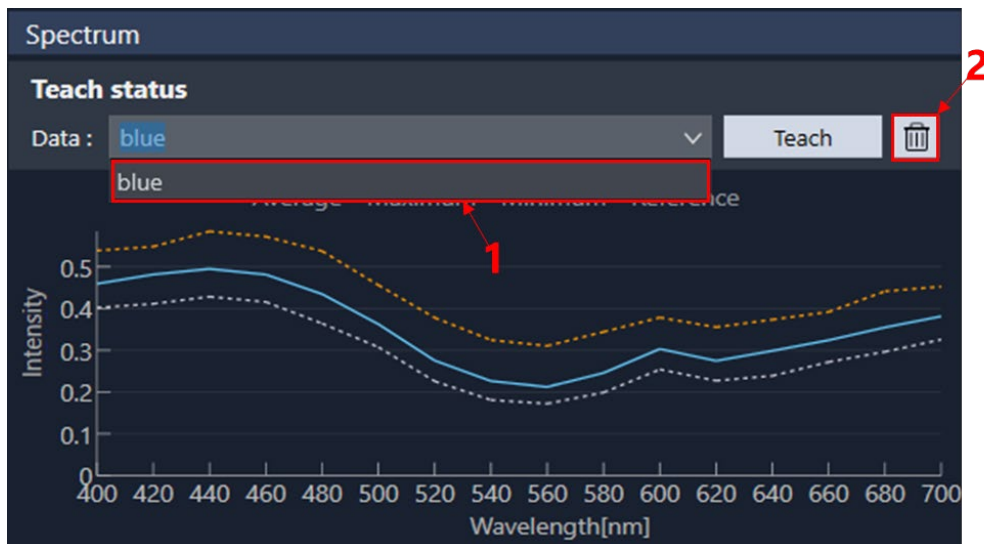

- (1) In the [Data] field 1, select the name of the data you want to delete.
- (2) Click the trash can button 2.

This section describes the procedure for deleting multiple registered data items at once. Registered data is saved in the following folder.

<D:\EpsonSVTools\Results\TeachDatas\ColorInspectors>

You can also open File Explorer and select multiple data items in this folder to delete them directly.

## 7.2.3 Color Inspection

Enter the following two fields to perform a color inspection. A color inspection cannot be performed if the following two fields are left blank.

The screenshot shows the 'Color inspection' window. The 'Data' field is set to 'blue' and the 'Lot No' field is set to '123456'. The 'Threshold' is set to 1.5. A blue 'Inspection' button is visible. The 'Inspection results' section shows 'deltaE : / Judgment :'. Red boxes highlight the 'Data' and 'Lot No' fields.

- (1) Select the data registered as an inspection reference standard in the [Data] field.
- (2) In the [Lot No] field, enter the lot number.

After entering the two fields above, perform the following:

- (1) Adjust the size of the search window 1, and place it over the inspection area.
- (2) Set the inspection threshold. 2  
There will be a slight amount of in-plane variation due to differences in the camera. If the inspection position changes in relation to the position set by the reference measurement, adjust the threshold value to account for this in-plane variation.
- (3) Click the <Inspection> button 3.  
The color inspection will begin.
- (4) Once the color inspection ends, the color difference, registered data judgments, and overall results will be output. 4

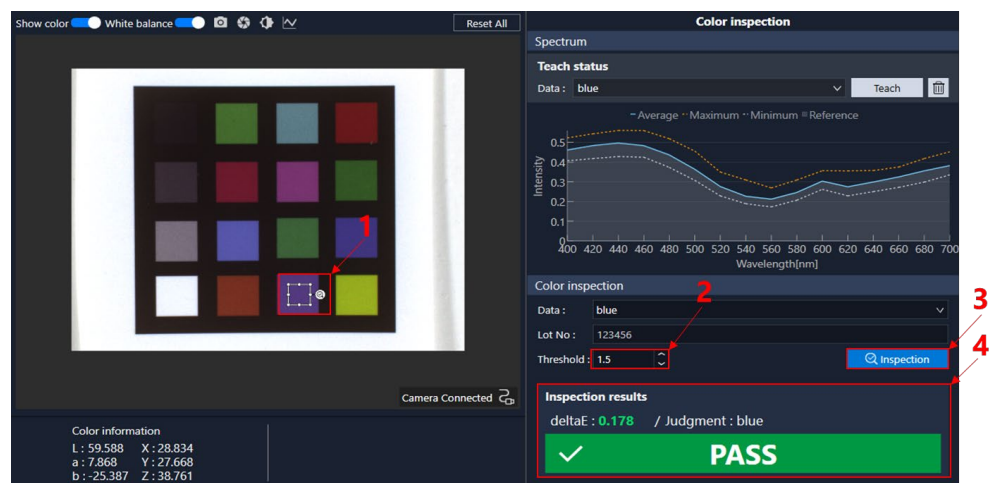

If “Lab” is selected for the [ColorInspection mode] in [Settings], the [deltaE] is displayed. The [deltaE] refers to the color difference between the selected inspection reference standard and the specified search window.

If “Spectrum” is selected for the [ColorInspection mode] in [Settings], the [deltaW] is displayed. The [deltaW] refers to the difference in the spectrum waveform between the selected inspection reference standard and the specified search window.

The registered data judgment [Judgment] calculates the color difference between the average color information in the search window under inspection and all registered data, and displays the registered data with the smallest color difference within all registered data, provided that it falls below the set threshold. If it exceeds the threshold, the [Judgment] field will display “Unknown”. As calculations are performed on all registered data, the greater the amount of registered data to process, the longer the processing time will be.

If the color difference [deltaE] falls below the set threshold, and the registered data judgment [Judgment] matches the inspection reference standard, a “PASS” judgment is output as the overall result. If these conditions are not met, a “FAIL” judgment is output.

### 7.2.4 Save Analytical Data

To output spectral and color information on the inspection target, and inspection results, click **Save analytical data**.

The following data is saved in json format.

Inspection target name, lot number, threshold value, color-matching function, light source, color difference formula, color inspection mode, color difference (Mahalanobis distance), judgment, results, size and position of the search window during inspection, and the average spectrum (400 to 700 nm, 20 nm increments)  
XYZ, Lab, xy, u'v'

Measurement results are saved to the following folder.

<D:\EpsonSVTools\Results\Projects\Name of created project\Name of measurement data>  
Data name: ColorInspector\_(Any string of 40 characters or less).json

## 7.3 Color Difference Distribution

The Spectroscopic Camera can perform a measurement for spectrum across an entire surface area. This makes it possible to obtain spectrum, or color information of an image on a per-pixel basis. This analysis function is used to measure color on a per-pixel basis. This function calculates the per-pixel color difference in relation to color information set as a reference, and outputs it as an image. The color difference heatmap outputs a heatmap as a color image to provide a visual representation of uneven color patterns. You can also perform per-pixel color inspections by setting a color difference threshold.

### 7.3.1 Reference Lab Configuration

There are two ways to configure Reference Lab settings: by specifying settings in the search window, or by direct value entry.

To specify Reference Lab settings in the search window, change the size and position of the search window to place it over the area you want to use as the reference color in comparisons.

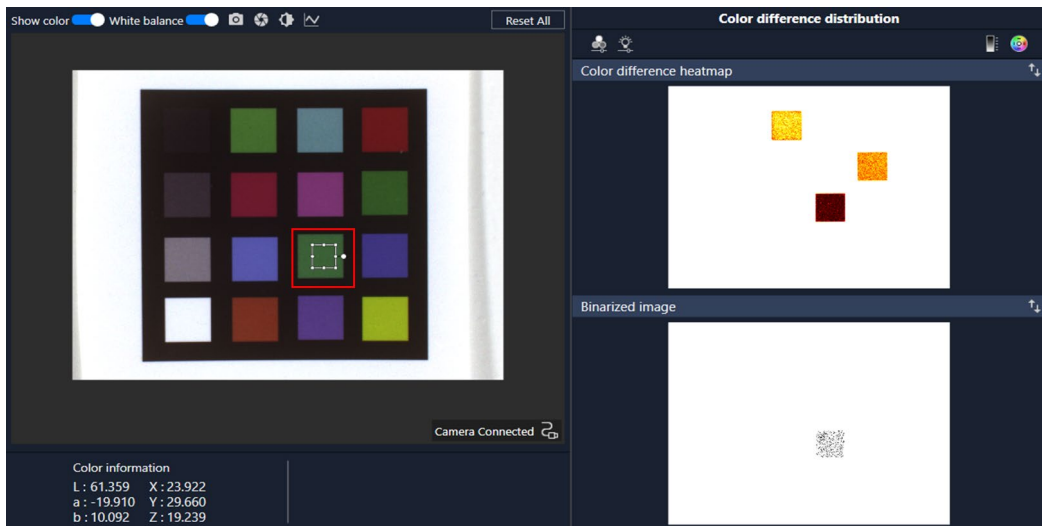

To directly enter the Lab value, follow the procedure below.

- (1) Click the  icon 1.
  - (2) The Reference Lab text box 2 will appear.
  - (3) Enter the value into the Reference Lab text box. 3
  - (4) Click the <Set> button 4.
- The Reference Lab value entered will be applied.

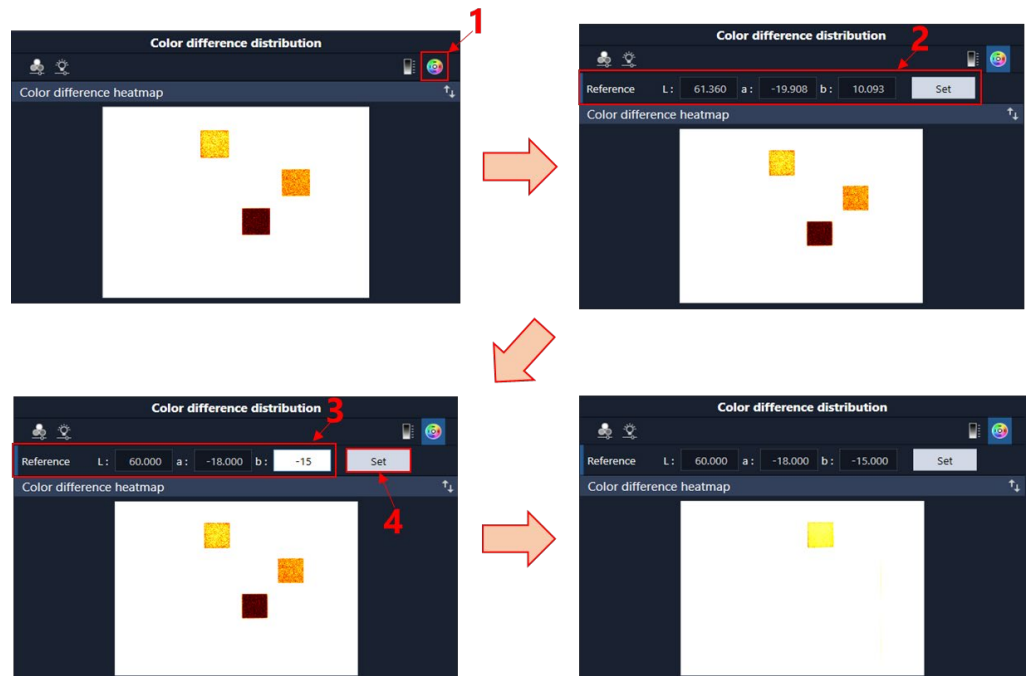

### 7.3.2 Color Difference Heatmap Configuration

The color difference heatmap is a color image that depicts the degree of color difference as a color gradient. You can change the color difference and colors shown in a color difference heatmap. Click the  icon 1 to display the track bar 2.

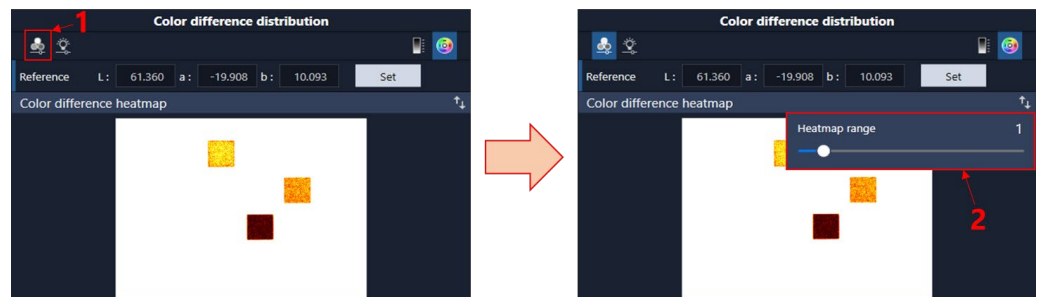

Change the track bar value to change the color difference and colors shown in a color difference heatmap. Increase the track bar value to expand the range of color differences shown in color. Click on the track bar to make minor adjustments in 0.1 increments.

The brighter the color difference heatmap, the larger the color difference range depicted.

Click the  icon 1 to display the color and color difference scale 2.

Changing the range

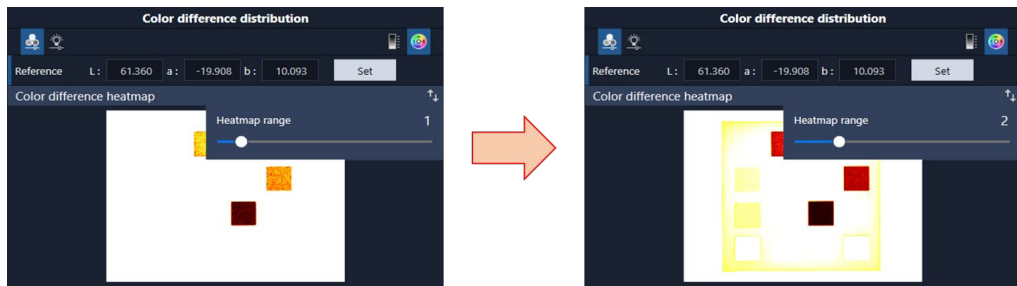

Color relationship between color difference and the color difference heatmap

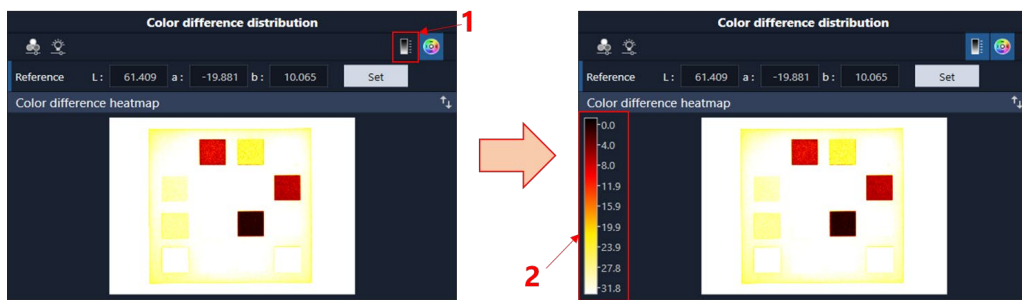

### 7.3.3 Binarized Image Configuration

Binarized images are monochrome images that either appear in black if the color difference is below the threshold value, or in white if the color difference is at, or above, the threshold value. You can also perform per-pixel color inspections by setting a color difference threshold. Click the  icon 1 to display the track bar 2.

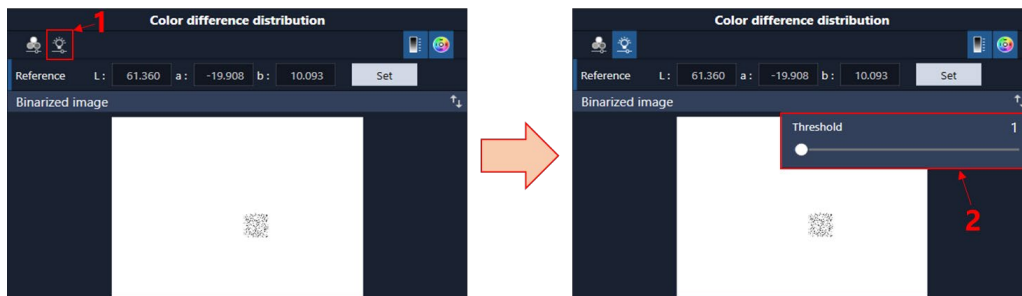

Use the track bar to change the color difference threshold value. Click on the track bar to make minor adjustments in 0.1 increments.

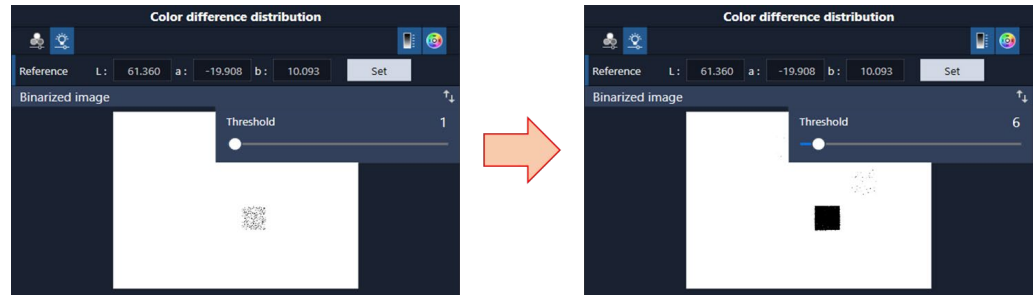

### 7.3.4 Save Analytical Data

Click **Save analytical data** to save color difference distribution settings information.

The following data is saved in json format.

Color difference threshold values, reference Lab, heatmap range

Color-matching function, light source, color difference formula

Measurement results are saved to the following folder.

<D:\EpsonSVTools\Results\Projects\Name of created project\Name of measurement data>

Data name: ColorDifferenceDistribution\_(Any string of 40 characters or less).json

## 7.4 Color Unevenness Inspection

This function splits the measurement range in a matrix and calculates the color difference of each block to detect unevenness in the measurement target. Select either the overall average Lab of the measurement target, or a split block as the Lab to use as a reference.

### 7.4.1 Usage

Change the following to start a color unevenness inspection.

The size and position of the search window

The number of divisions in the search window, and the threshold value

deltaE Reference

A “PASS” judgment will appear if the color difference of each split block falls under the threshold value. A “FAIL” judgment will appear if this is at or above the threshold value. Blocks at or above the threshold value will appear in an orange frame.

This section describes an example procedure for inspecting color unevenness.

STEP1.

Adjust the size and position of the search window, and place it over the inspection target.

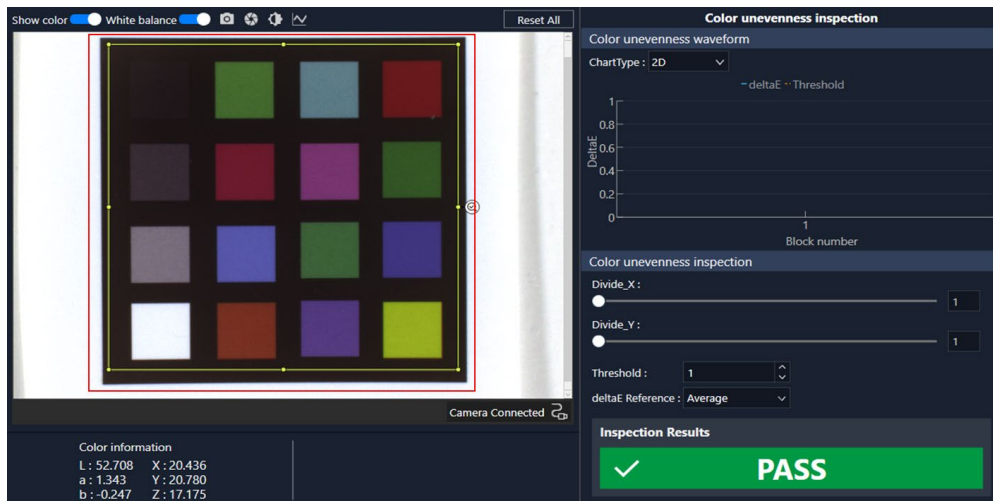

STEP2.

Specify the number of divisions in the width direction (Divide\_X) and the height direction (Divide\_Y) of the search window. You can change the number of divisions for each with the track bar. Changing the number of divisions will change the [deltaE Reference] to "Average" (the average Lab in the search window). Note that the higher the number of divisions, the longer it will take to calculate color unevenness and display the results.

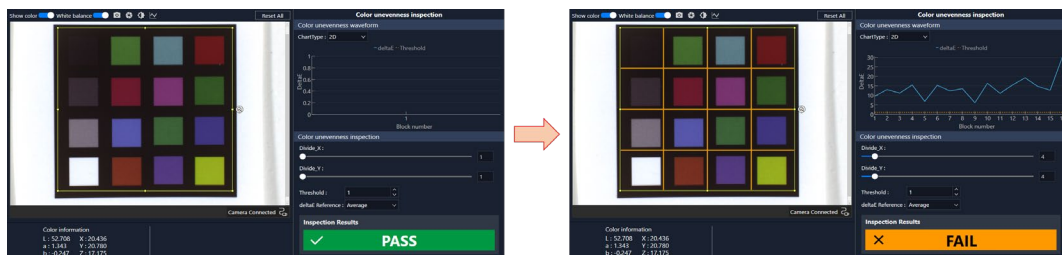

STEP3.

Set the threshold value.

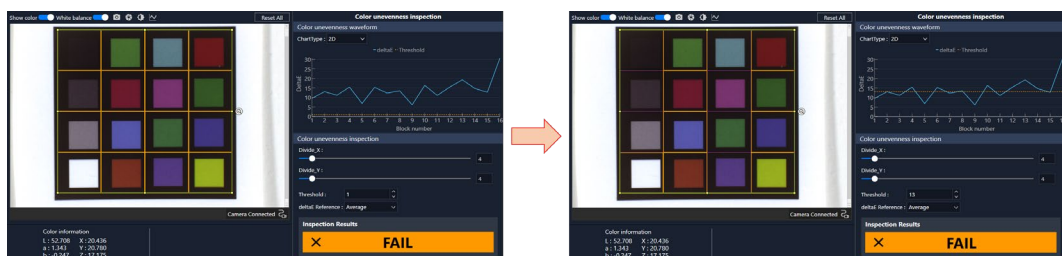



STEP4.

Use the [deltaE Reference] to select the block to use as the reference Lab.

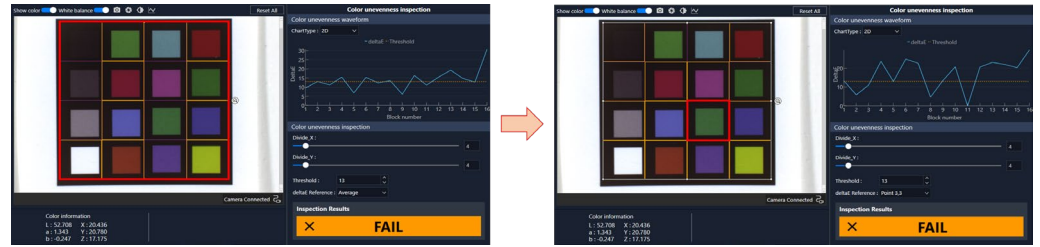

### 7.4.2 Color Unevenness Waveform Graph

You can choose between a 2D and a 3D color unevenness waveform graph.

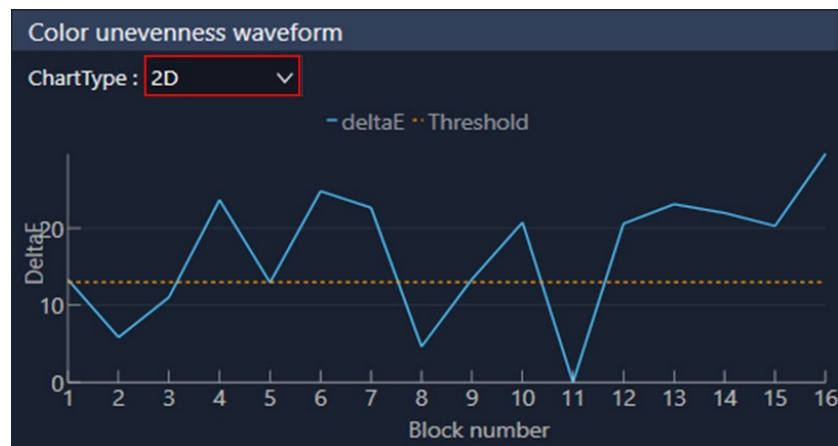

The 2D graph depicts a waveform line beginning with the block on the upper left.

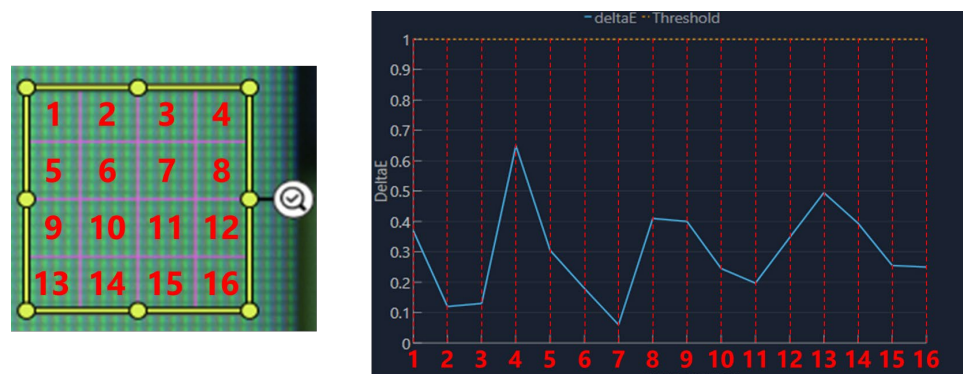

The 3D graph is a contour display graph. Drag the graph to rotate the 3D graph.

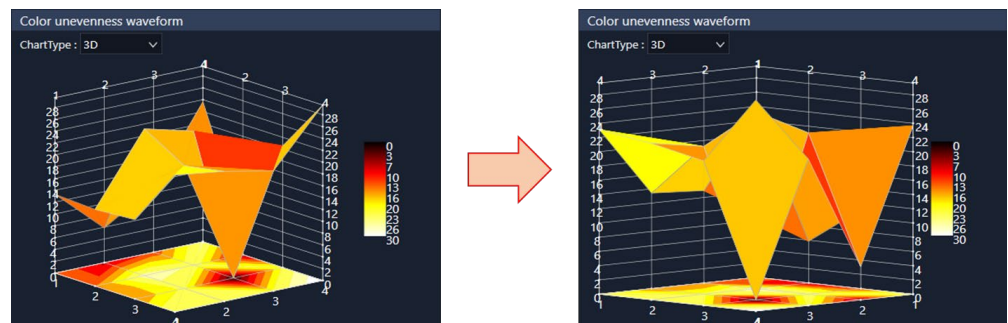

### 7.4.3 Saving Data

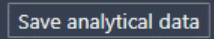
To output color unevenness inspection results data, click .

The following data is saved in json format.

Average Lab, Lab for each block

Color difference for each block, light source, color-matching function, color difference formula, number of divisions in the horizontal direction, number of divisions in the vertical direction

Search window information (position and size)

Measurement results are saved to the following folder.

<D:\EpsonSVTools\Results\Projects\Name of created project\Name of measurement data>

Data name: UnevennessOutput\_(Any string of 40 characters or less).json

## 7.5 Spectrum Distinction

This function identifies consistencies in the spectral shape with the spectrum on a per-pixel basis based on a pre-registered spectral data group, and colors in areas of the image at or below the threshold value in the registered color to be output as a color image.

In contrast to the color inspection function which uses Lab, the spectrum distinction function uses the spectral shape (16 data) to make judgments. Spectral information contains a larger volume of information compared to color information Lab, allowing for judgments with a higher degree of accuracy.

### 7.5.1 Data Registration (New)

This section describes the procedure to register new data in the following steps.

STEP1.

Adjust the size and position of the search window, and place it over the data registration position.

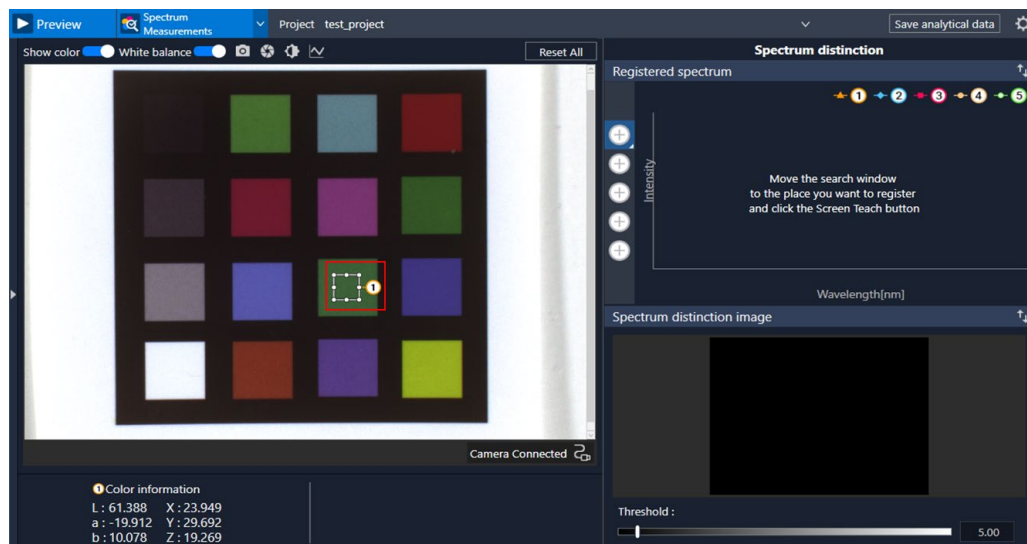

STEP2.

- (1) Click the data registration icon 1 for the data being registered.
- (2) The data registration panel 2 will appear.

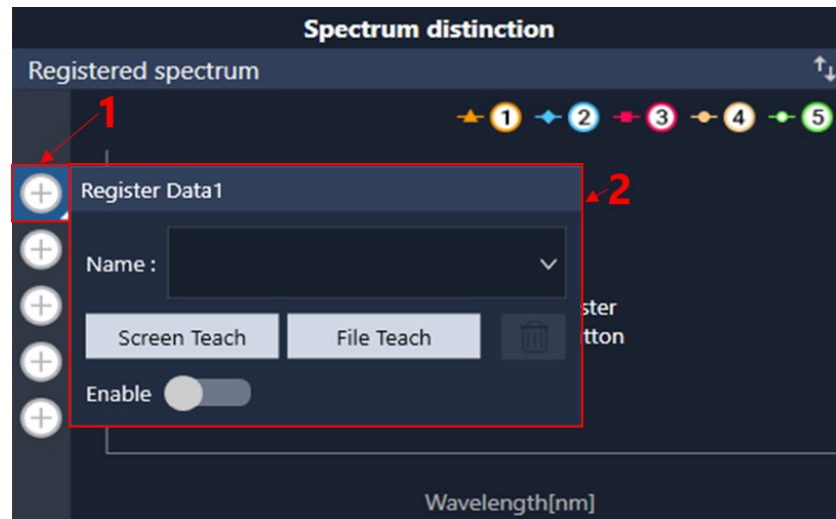

STEP3.

- (1) In the [Name] field 1, enter the name of the data to be registered.
- (2) Click the <Screen Teach> button 2.  
This ends the data registration process.
- (3) The average/maximum/minimum spectrum of the registered data is plotted on the spectral graph. 3
- (4) The spectrum distinction image will appear. 4

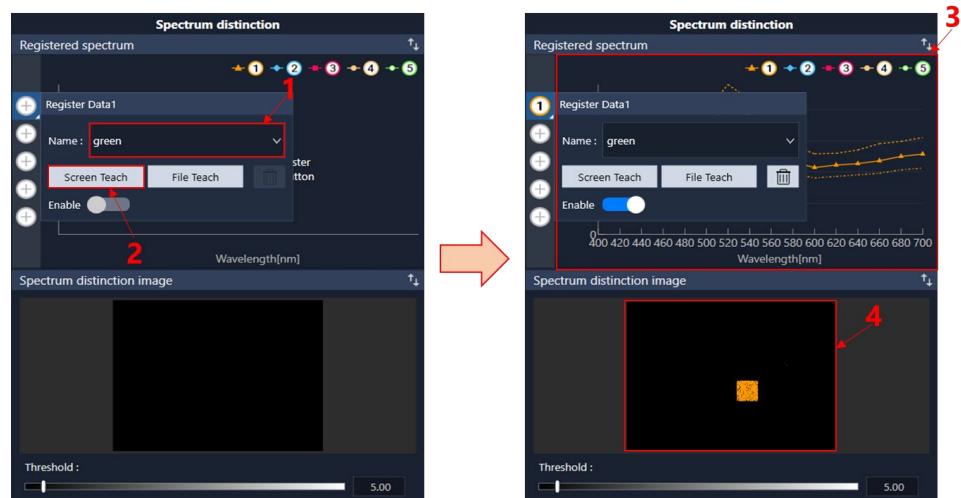

STEP4.

To continue registering new data, click a different data registration number, and then repeat steps 1 through 3.

Points to be aware of when registering data:

There may be differences particular to individual Spectroscopic Cameras, lenses, and lighting. When replacing the camera, complete the data registration process again. In addition, the following aspects of the overall measurement system may impact the measurement results.

- The type of lighting and lens used
- The positional relationship between the lighting, Spectroscopic Camera, and the measurement object
- Individual differences in the lighting, Spectroscopic Camera, and lens
- The brightness of the lighting, and the lens focus and aperture condition

Once an inspection reference standard has been established by measuring reference samples and data registration, do not alter these elements of the measurement system. If changed, reset the inspection reference standard again beginning with measuring the white balance.



When purchasing multiple systems, you will need to redo the data registration process in the same way as when replacing the hardware.

### 7.5.2 Data Registration (Loading Data)

You can also register data by loading teach data created as new registration data.

This section describes the procedure to register data from loaded data in the following steps.

STEP1.

- (1) Click the data registration icon  1 for the data being registered.
- (2) The data registration panel 2 will appear.

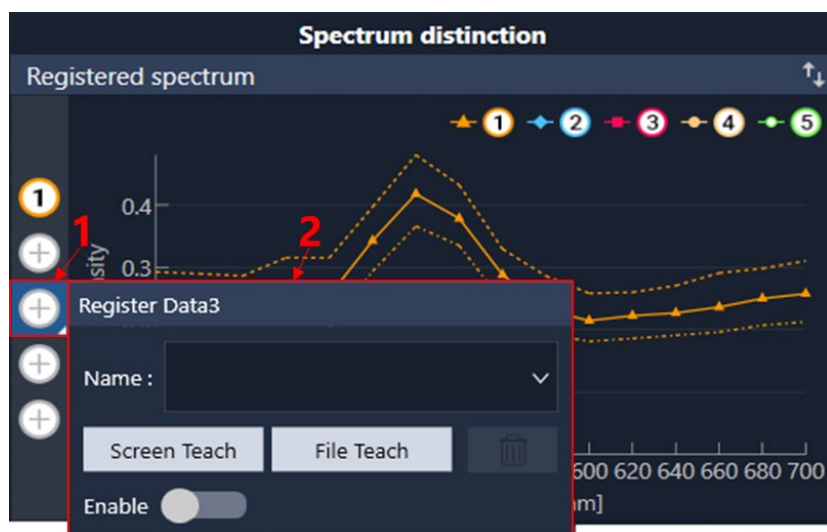

## STEP2.

- (1) In the [Name] list 1, select the name of the file to load.
- (2) Click the <File Teach> button 2.

This ends the data registration process. After data registration is complete, the average/maximum/minimum spectrum of the registered data is plotted on the spectral graph. The spectrum distinction image will also appear at the same time.

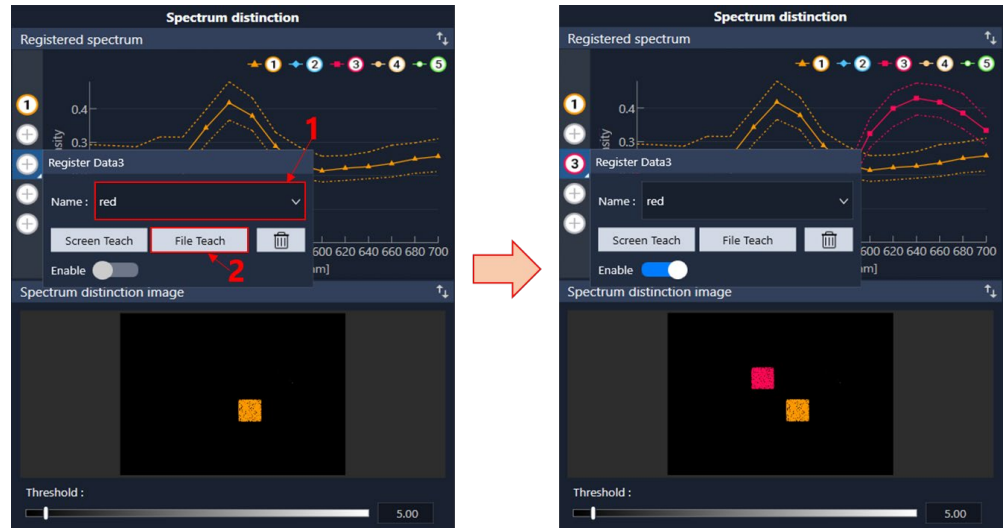

## 7.5.3 Hiding Registered Data

You can also remove registered data as identification objects. Registering all five data slots may overly complicate spectrum distinction images. Hiding registered data is useful when you want to only show the areas that need to be shown, and to display simple spectrum distinction images.

The operating procedure is described below.

- (1) Click the data registration number you want to hide from view.
- (2) Turn the [Enable] ON/OFF sliding switch to the OFF position.  
When set to OFF, the spectrum distinction image will update.

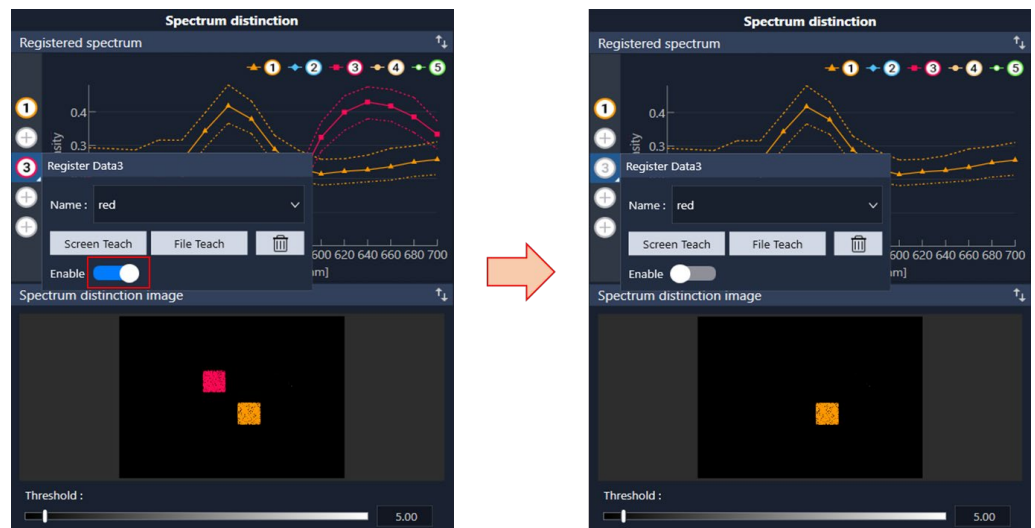

### 7.5.4 Delete Registered Data

This section describes the procedure for deleting registered data.

- (1) In the [Name] list 1, select the name of the data to delete.
- (2) Click the trash can button 2.

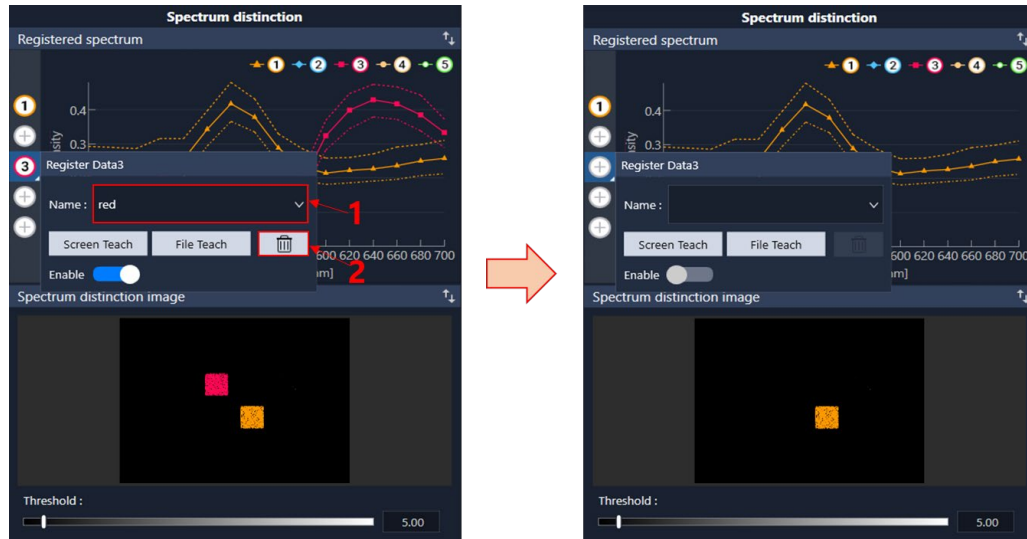

This section describes the procedure for deleting multiple registered data items at once. Registered data is saved in the following folder.

<D:\EpsonSVTools\Results\TeachDatas\SpectrumMatches>

You can also open File Explorer and select multiple data items in this folder to delete them directly.

### 7.5.5 Spectrum Distinction Image Threshold Settings

Change the threshold value to output an updated spectrum distinction image.

Increase the threshold value to only fill in the registered area. Increasing the threshold value further will fill in spectral shapes similar to the registered spectral shapes. Click on the threshold track bar to make minor adjustments in 0.01 increments.



### 7.5.6 Saving Configuration Data

Click  to save spectrum distinction settings information.

The following data is saved in json format.

Threshold

Registered data name

Measurement results are saved to the following folder.

<D:\EpsonSVTools\Results\Projects\Name of created project\Name of measurement data>

Data name: SpectrumDistinction\_(Any string of 40 characters or less).json

## 7.6 Fabric Inspection

Clothing, lace, and other such products have highly uneven surfaces, resulting in areas that are reflected as fiber colors, and areas in shadow due to the effect of the weave. Further, since clothing is woven with fibers, the angle of the light may result in specular reflection of the fiber.

A typical point-based colorimeter will average out the glossy reflection of the fiber and the surface unevenness when performing measurements. Differences in surface unevenness at the weave in the fabric will cause variation in the color values measured at different points of measurement. In addition, as measurements take the average of all light information, the results of a visual inspection viewed in 2D may greatly deviate from the measurement results.

Conversely, a Spectroscopic Camera allows for surface measurements, making it possible to separate the Glossy Part, Bright Part, and Dark Part of an image to only extract the areas of the image needed. This produces results that closely aligns with that of a visual inspection.

In this example, we will register a single data item by combining the following three data elements - namely, the specular reflection off the master cloth product (the Glossy Part), the Bright Part caused by diffuse reflection, and the Dark Part resulting from surface unevenness in the weave. The color information Lab based on the registered data is extracted for the Glossy Part, Bright Part, and Dark Part of products under inspection with the same color number and different weaving methods based on the spectral data in order to calculate the color difference for the registered data Lab. If the color difference falls below the threshold value, a "PASS" judgment is output. If it is at or above the threshold value, a "FAIL" value is output.

### 7.6.1 Data Registration

This section describes the procedure to register data in the following steps.

#### STEP1.

- (1) Change the size and position of the search window, and place the Glossy Part, Bright Part, and Dark Part to register over the measurement target area.
- (2) Click the <Set> button for the Glossy Part, Bright Part, and the Dark Part.  
This displays the average spectrum in the search window on the graph.

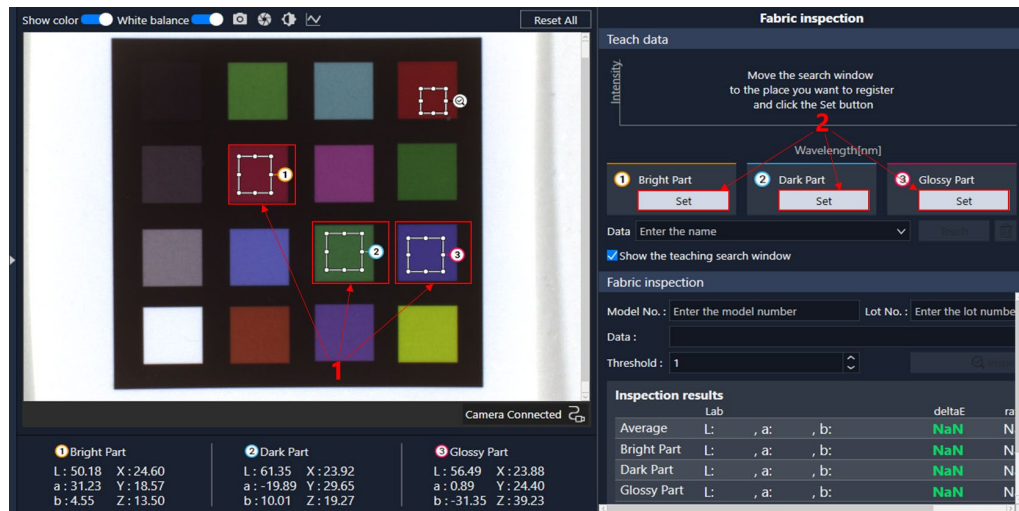

#### STEP2.

If the search window has been properly placed over the measurement target area from the spectral graph, proceed to the next step to register the data.

- (1) In the [Data] field 1, enter the name of the data you want to register.
- (2) Click the <Teach> button 2.

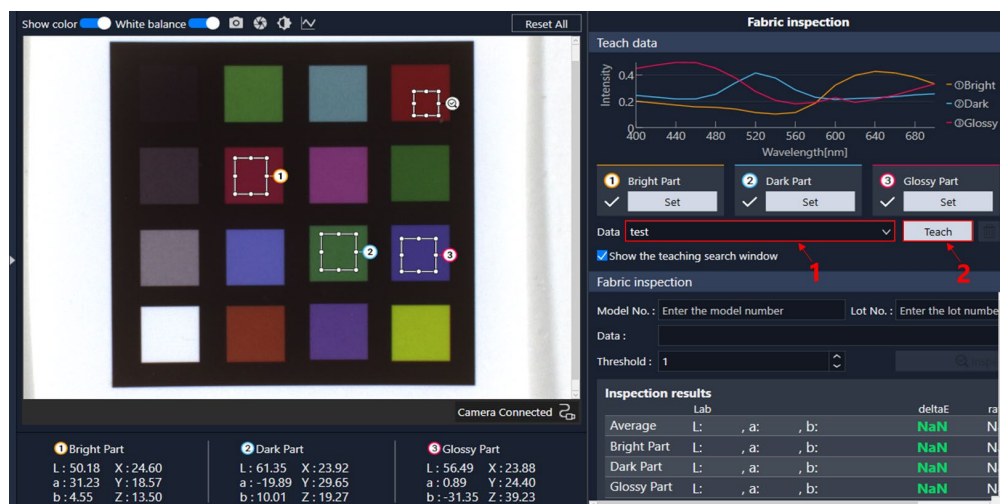



Points to be aware of when registering data:

There may be differences particular to individual Spectroscopic Cameras, lenses, and lighting. When replacing the camera, you will need to complete the data registration process again. In addition, the following aspects of the overall measurement system may impact the measurement results.

- The type of lighting and lens used
- The positional relationship between the lighting, Spectroscopic Camera, and the measurement object
- Individual differences in the lighting, Spectroscopic Camera, and lens
- The brightness of the lighting, and the lens focus and aperture condition

Once an inspection reference standard has been established by measuring reference samples and data registration, do not alter these elements of the measurement system. If changed, reset the inspection reference standard again beginning with measuring the white balance.



When purchasing multiple systems, you will need to redo the data registration process in the same way as when replacing the hardware.

### 7.6.2 Delete Registered Data

This section describes the procedure for deleting registered data.

- (1) In the [Data] list 1, select the name of the data you want to delete.
- (2) Click the trash can button 2.

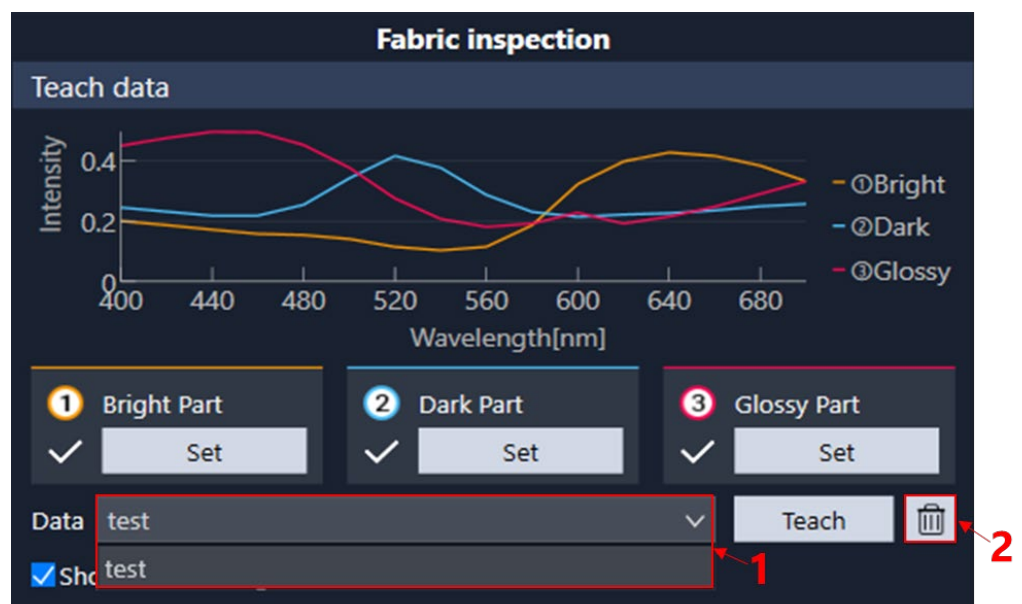

This section describes the procedure for deleting multiple registered data items at once. Registered data is saved in the following folder.

<D:\EpsonSVTools\Results\TeachDatas\Fabrics>

You can also open File Explorer and select multiple data items in this folder to delete them directly.

### 7.6.3 Color Inspection

STEP1.

Enter or select Model No, Lot No, Data, and Threshold (1 to 4) for color inspection. There will be a slight amount of in-plane variation due to differences in the camera. If the inspection position changes in relation to the position set by the reference measurement, adjust the threshold value to account for this in-plane variation.

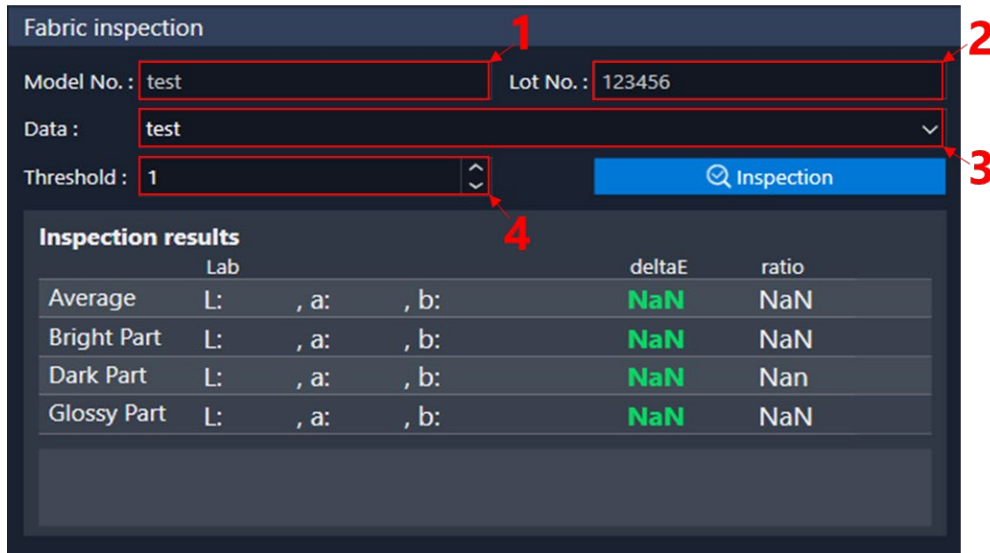

STEP2.

- (1) Place the search window over the inspection area. 1
- (2) Click the <Inspection> button 2.  
The color inspection will begin.
- (3) The Lab, color difference, ratio, and result are output as color inspection results.3

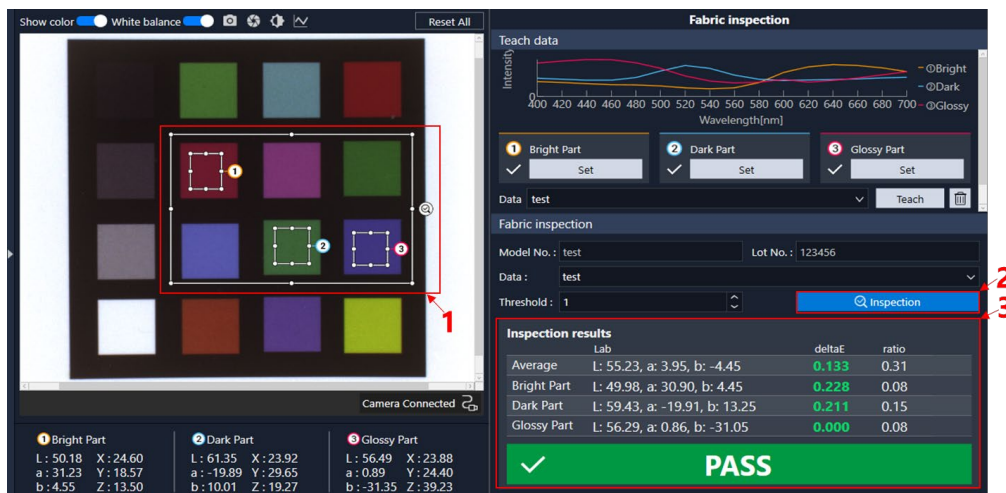

#### 7.6.4 Save Analytical Data

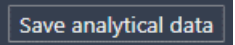
To output spectral and color information on the inspection target, and inspection results, click .

The following data is saved in json format.

Lab, color difference, and ratio for overall average, Glossy Part, Bright Part, and Dark Part for each

Light source, color-matching function, color difference formula, and the size and position of the search window at time of inspection, color inspection results

Measurement results are saved to the following folder.

<D:\EpsonSVTools\Results\Projects\Name of created project\Name of measurement data>

Data name: FabricInspection\_(Data name).json

## 8. Backing Up Measurement and Registered Data

Data measured and registered in Epson SV Tools is saved to each of the following folders. You can move measurement data and registered data to an external storage device such as a USB memory stick to create a backup. Backup data can be reused by restoring it to the original folder.

Measurement data (measurement for spectrum, measurement for white balance)

<D:\EpsonSVTools\Results\Projects\>

Registered data (color inspection)

<D:\EpsonSVTools\Results\TeachDatas\ColorInspectors\>

Registered data (spectrum distinction)

<D:\EpsonSVTools\Result\TeachDatas\SpectrumMatches\>

Registered data (fabric inspection)

<D:\EpsonSVTools\Result\TeachDatas\Fabrics\>

## 9. Tutorial

This section describes the procedure example for performing a color inspection on a sample using the Spectroscopic Camera in Epson SV Tools.

This tutorial describes only the operation procedures, so that you can become accustomed to performing them.

We will not be using actual parts for this tutorial, but instead we will use simple drawings of objects that you can then make copies of and put under a camera to follow the tutorial. This will guarantee that everyone has the same results when trying this tutorial.

This tutorial will include the following sections:

Before starting this tutorial

Example 1-1 : Color patch color/spectrum information

Example 1-2 : Color inspection of color patches

Example 1-3 : Per-pixel color inspection of gradient color charts

Example 2 : Color inspection of unevenness in printing

Example 3-1 : Spectrum distinction of lace fabric

Example 3-2 : Lace fabric inspection

### 9.1 Before Starting This Tutorial

First, check the following items.

- Fix the camera facing downward, and connect it correctly.
- Make sure that the sample placed on the table is visible.
- Copy the drawing of the target part, and place it under the camera.

Drawings of target parts are provided for each example.

## 9.2 Color Patch Color/Spectrum Information and Color Inspection

### 9.2.1 Purpose and Measurement Configuration

This tutorial demonstrates the potential to capture color and spectral differences in a spectrum by lot and model number for printing materials, cosmetics, construction materials, and other materials.

In this tutorial, we will verify the principle used to confirm whether color inspection is possible using the “Color / spectrum information” function.

We use the “Color inspection” function to perform a color inspection of the registered data. A color inspection is used, for example, for color inspections in relation to a registered reference product, and to control relative changes in color between lots.

You can use the “Color difference distribution” function to identify minor unevenness in color distribution.

The color chart prepared in this tutorial is intended for use with cosmetics (eye shadow) and foods (freshness and growing condition of fruit and vegetables), with slight gradation adjustments of green.

Other color charts include one prepared with slight gradation adjustments of red for use with cosmetics (lipstick), and one prepared with slight gradation adjustments of beige for use with cosmetics (hand creams, foundation) and tiles.

The following items are used in this tutorial.

#### Main products

- Spectroscopic Camera
- Spectroscopic Vision Controller
- USB 3.0 Spectroscopic Camera cable
- USB 2.0 Spectroscopic Camera cable

#### Optional products

- Camera tripod mount
- AC adapter
- C-mount lens with 8 mm focal length (the optional lens: HF818-12M)

#### Items you should provide

- Camera stand
- Keyboard
- Mouse
- Monitor
- LED bar lighting
- White plate (white paper in this example)

The figure below is a color chart used in the tutorial. Print it in A4 size / color, and cut the margins before using it.

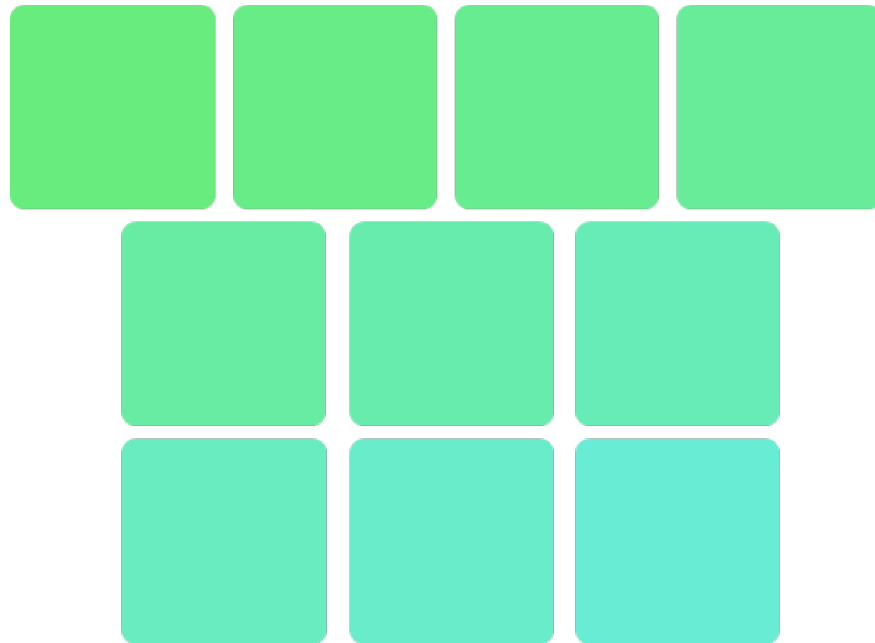

Although not used in this tutorial, the figures below are color charts for practice purposes to better acclimatize the user to using the color charts.

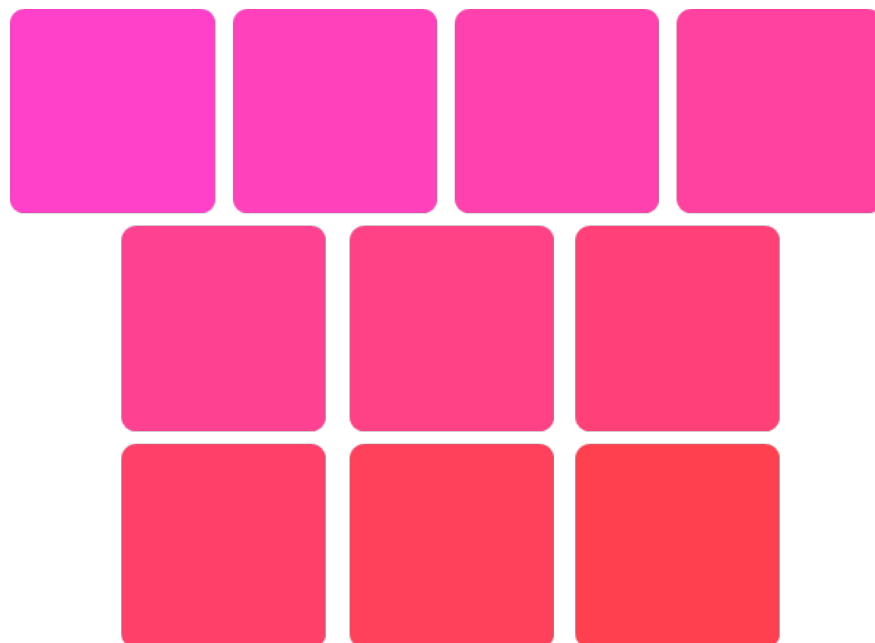

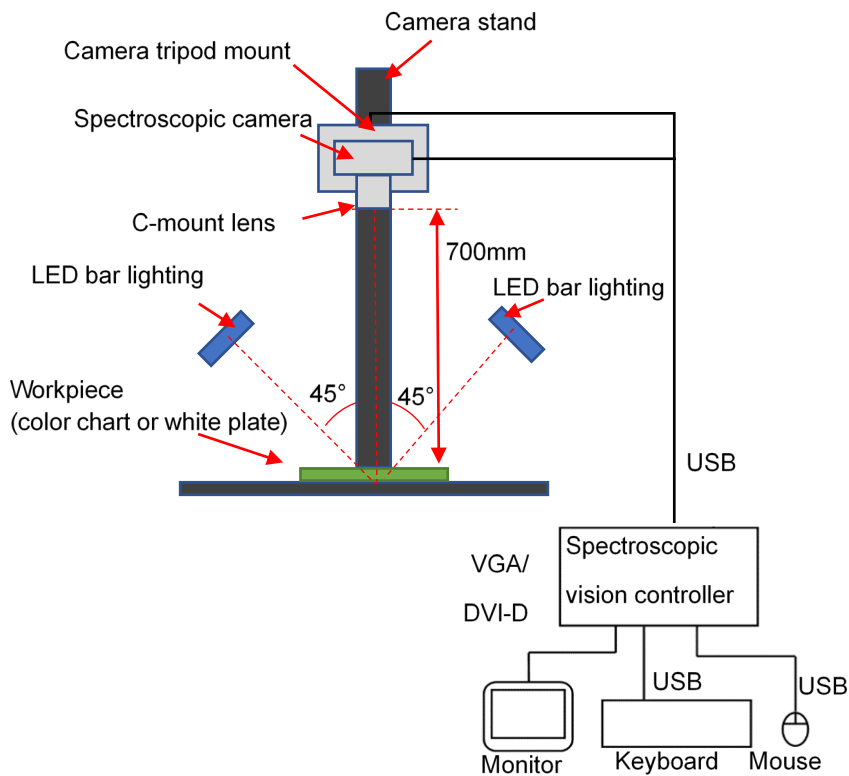
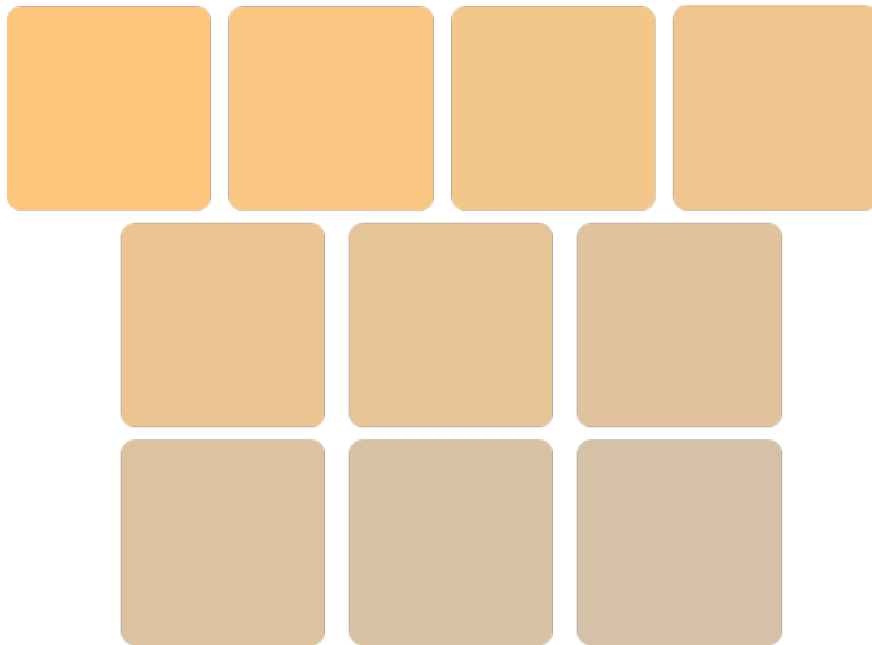

Measuring method for Color patch color, spectrum information and Color inspection

Lighting is required to measure the color reflected off the target. When measuring tiles with a flat and glossy surface, place the lighting at a 45° angle to the workpiece in order to prevent specular reflection due to gloss. If it is placed on only one side, uneven lighting and shadows will be created when recognizing the shape of the tile. So, it is configured to illuminate at a 45° angle from both sides. The field of view of measurement is determined by the working distance (the distance from the tip of the lens on the Spectroscopic Camera to the



measurement workpiece), the resolution of the Spectroscopic Camera, and the focal length of the lens.

- Working distance: 700 mm
- Spectroscopic camera resolution: 1024 x 768
- C-mount lens with 8 mm focal length (the optional lens: HF818-12M)

### 9.2.2 Start Epson SV Tools and Create a New Project

- (1) Turn on the Spectroscopic Vision controller.
- (2) Double-click the <Epson SV Tools> icon on the Windows desktop.
- (3) As we are creating a new project, enter the name of the project.  
“ColorInspection” is used in this example as the project name.

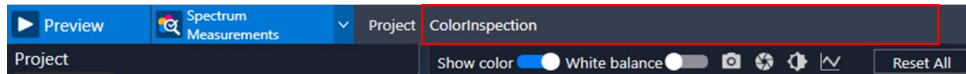

### 9.2.3 Measurement for White Balance

- (1) Click the <Preview> button to start the preview.

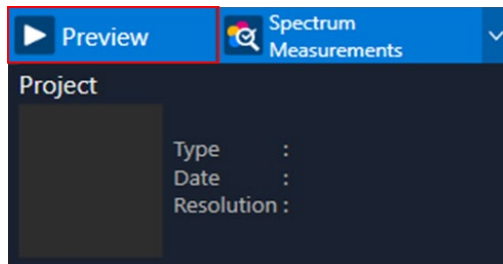

- (2) Set a white plate, and then adjust the exposure time to increase the brightness of the preview screen.  
The exposure time shown in the figure below is intended as a reference. The actual exposure time will vary depending on the light intensity.

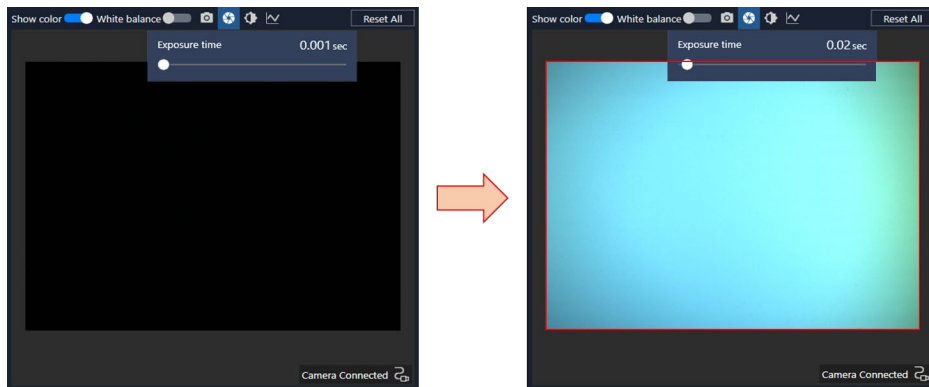

- (3) Move the white plate up and down, and to the left and right so that the white plate takes up the entire preview screen.
- (4) Change the measurement mode from “Measurement for spectrum” to “Measurement for white balance”.

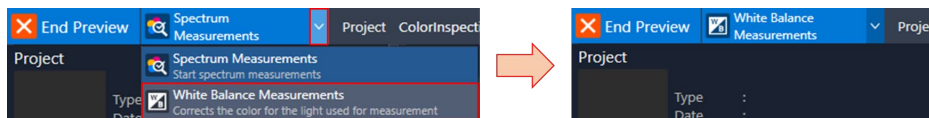

- (5) 1 Click the <Measurement for white balance> button.
- 2 The [Measurement] dialog box is displayed.
- 3 In the [File name:] field, enter the name of the save data.  
In this tutorial, the data is named “white13”.
- 4 Click the <Save> button.
- 5 The current progress is shown on the progress bar on the status bar.

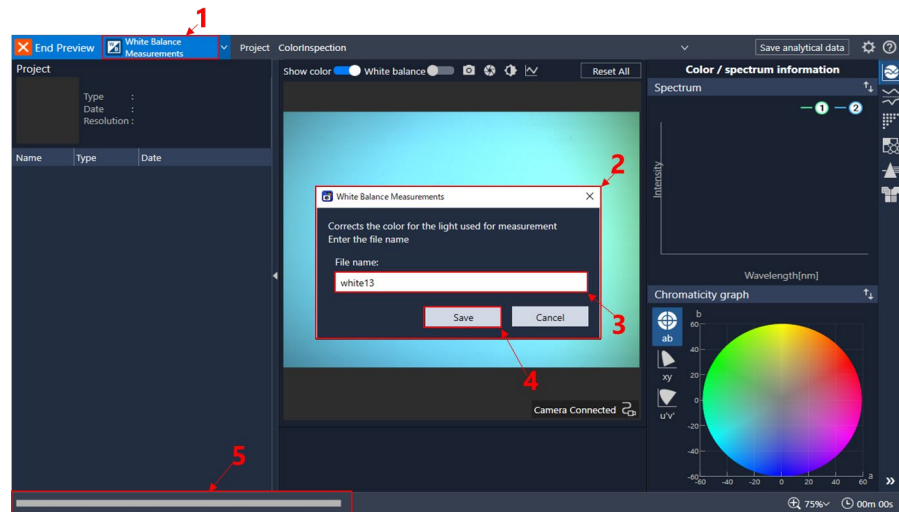

Once the measurement for white balance is complete, the measurement data is displayed in the data browser.

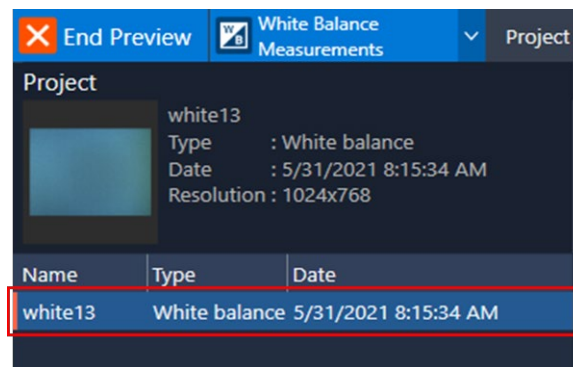

- (6) To apply the white balance, turn the white balance switch in the preview settings menu from “OFF” to “ON”. When the white balance setting is “ON”, a white balance will be applied when performing measurements for spectrum, or when loading measurement for spectrum data.

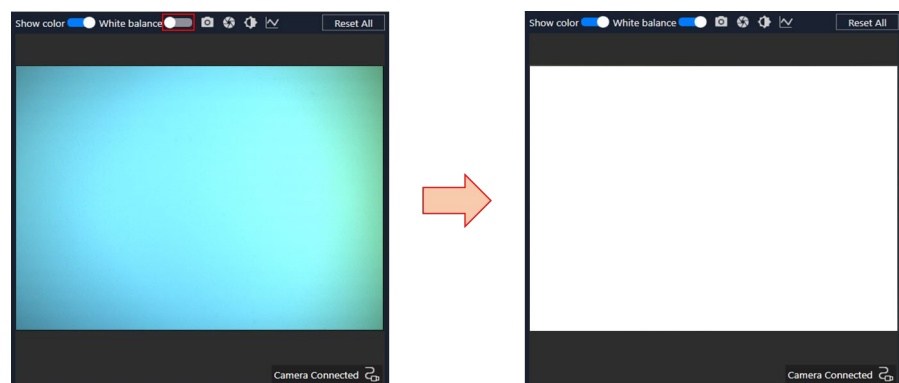

### 9.2.4 Measurement for Spectrum of Color Patches

- (1) Click the <Preview> button.

The preview will start.

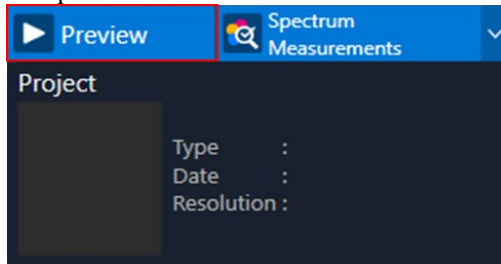

- (2) Place the measurement object so that it fills the entire preview image area of the Spectroscopic Camera.

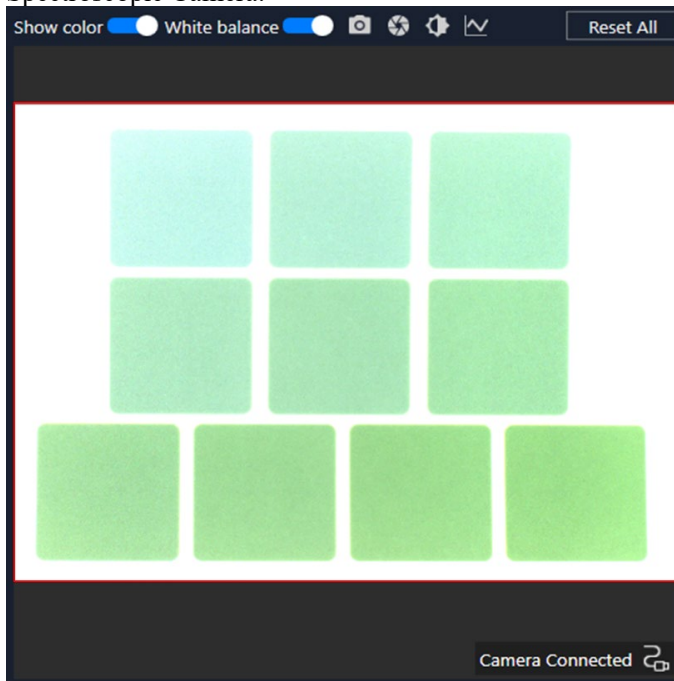

- (3) Change the measurement mode to “Measurement for spectrum”.

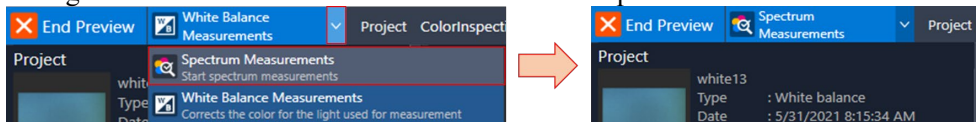

- (4) 1 Click the <Measurement for spectrum> button.
- 2 The [Measurement] dialog box is displayed.
- 3 In the [File name:] field, enter the name of the save data.  
In this tutorial, the data is named “ColorChart1”.
- 4 Click the <OK> button.
- 5 The current progress is shown on the progress bar on the status bar.

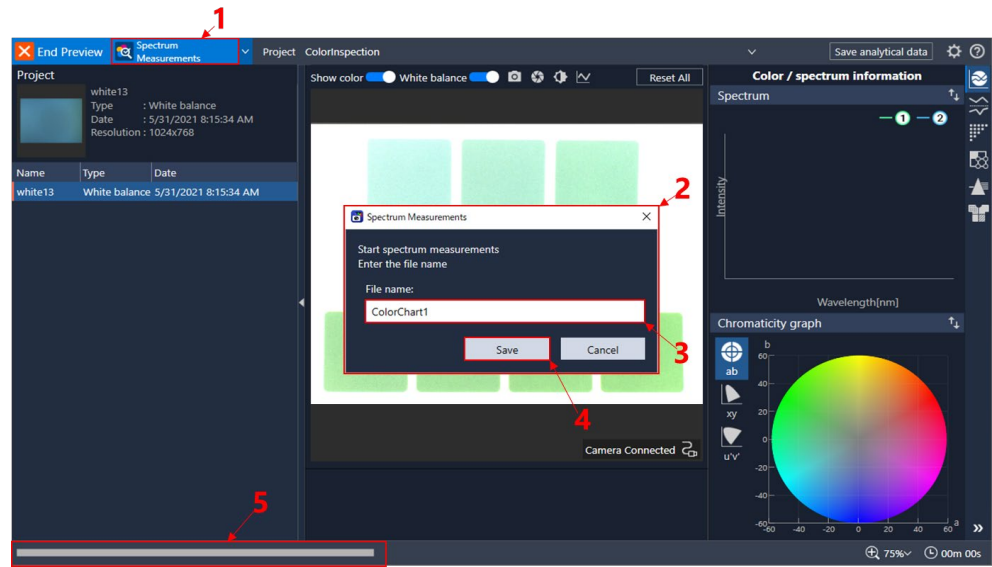

Once the measurement for spectrum is complete, the measurement data is displayed in the data browser.

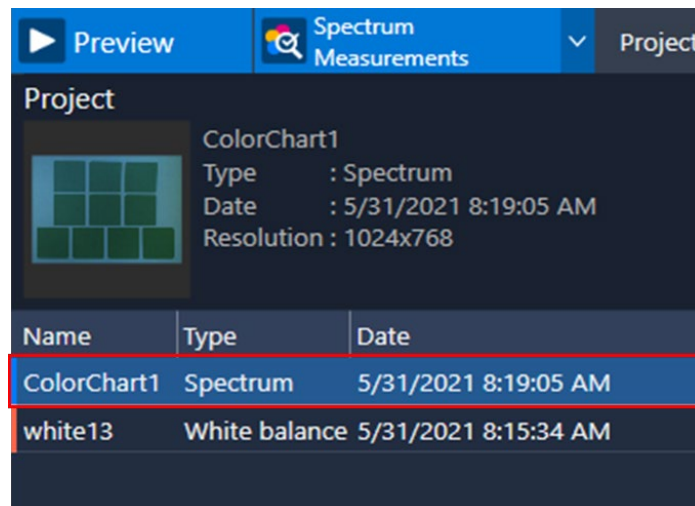

## 9.2.5 Color / Spectrum Information

This tutorial demonstrates the potential to capture color and spectral differences in a spectrum by lot and model number for printing materials, cosmetics, construction materials, and other materials.

In this tutorial, we will verify the principle used to confirm whether color inspection is possible using spectral information. The operating procedure is described below.

- (1) After measurement is complete, or after loading earlier measurement data, the search windows ① and ② will appear. For more information on how to load data, refer to *5.1 Loading Data*.

Adjust the size of the search window so that it fits within the measured color patch.

The color patch prepared for this tutorial has slight changes in color gradation, which can be difficult for the human eye to discern when the colors are arranged next to one another.

Place the search windows ① and ② over each color patch as shown in the figure below.

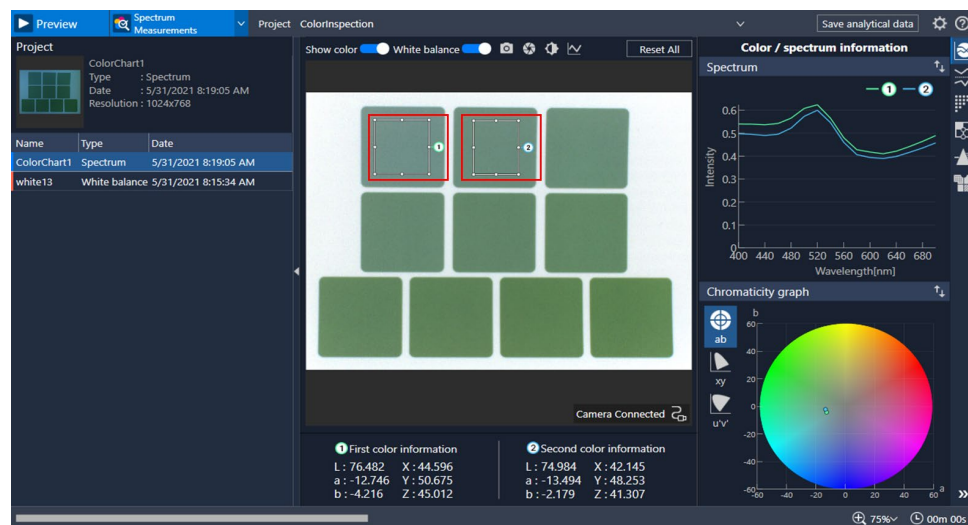

Moving the search windows will update the following three pieces of information in real-time.

- Average color information
- Spectral graph
- Chromaticity graph

The spectral graph and chromaticity graph provide a visual representation of differences in the average color information in the search windows ① and ② specified by the user.

The chromaticity graph provides a visual representation of both the color differences and what colors are present. As a red color patch is specified in this example, the graph is plotted in the red area.

The color difference formula  $\Delta E$  is recommended for use when determining differences in color on a numerical basis. The following shows the simplest formula for calculating the color difference  $\Delta E_{76}$ .

$$\text{Color difference } \Delta E_{76} = \sqrt{(L1 - L2)^2 + (a1 - a2)^2 + (b1 - b2)^2}$$

Substituting the color information in the search windows ① and ② gives the following formula.

$$\begin{aligned} \text{Color difference } \Delta E_{76} &= \sqrt{(76.482 - 74.984)^2 + (-12.746 + 13.494)^2 + (-4.216 + 2.179)^2} \\ \text{Color difference } \Delta E_{76} &\cong 2.637 \end{aligned}$$

The smaller the color difference value, the smaller the color difference. Set a threshold for this color difference to perform a color inspection. For a tutorial on color inspections, refer to 9.2.6 *Color Inspection of Color Patches*.

## 9.2.6 Color Inspection of Color Patches

This is a tutorial for measuring multiple targets at the same time, and inspecting the color difference against both a standard and the overall color average.

In addition to inspecting the color difference against a good product, you can manage colors between lots and quantify colors. You can inspect cosmetics, fabrics, building material tiles, colored pencils and other writing materials, vegetables, fruit, etc.

The color patch prepared in this tutorial is intended for use with cosmetics (eye shadow) and foods (freshness and growing condition of fruit and vegetables), with slight gradation adjustments of green.

### 9.2.6.1 Data Registration

- (1) After measurement is complete, or after loading earlier measurement data, the search window ② will appear. For more information on loading measurement data, refer to 5.1 *Loading Data*.

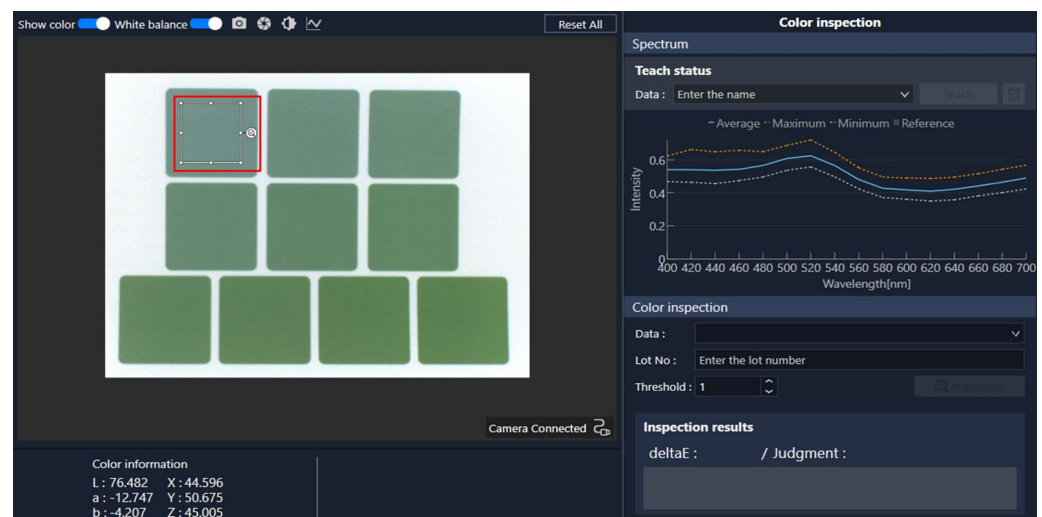

- (2) 1 Adjust the size and position of the search window, and place it over the area you want to register data for. In this example, we will register the color patch in the upper left corner.
- 2 Once the search window is placed, enter the data name in the [Data] field. (In this tutorial, “green1” is used as the data name)
- 3 Click the <Teach> button.

This ends the data registration process.

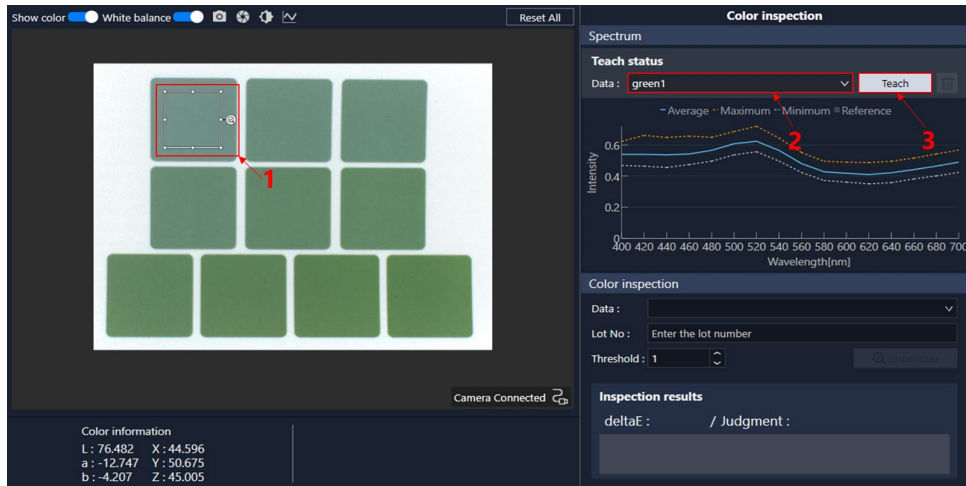

- (3) Repeat steps (1) and (2) described above for the remaining nine color patches to register data as shown in the figure below.

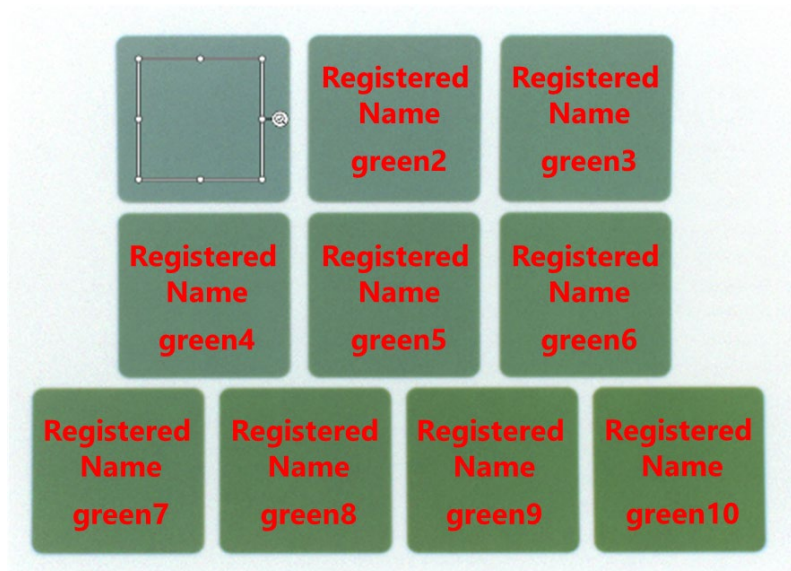



## 9.2.6.2 Color Inspection

- (1) Perform a color inspection.

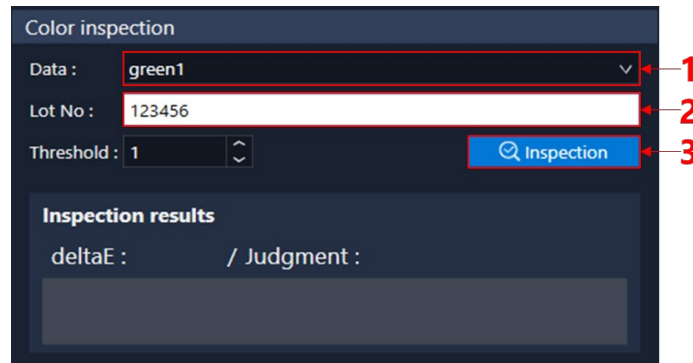

1 Select the data registered as an inspection reference standard from the [Data] list.  
In this tutorial, we select “green1”.

2 Enter the [Lot No].  
Any alphanumeric character string is acceptable.

3 Once you finish entering the character string, the <Inspection> button will become available. Click the button to perform a color inspection.

- (2) After entering the two fields above, perform the following:

1 Adjust the size of the search window, and place it over the area you want to inspect.  
In this tutorial, we will place it in the same position as the color patch we registered data for (upper left corner).

2 Set the inspection threshold.  
Set this to “0.6”.

3 Click the <Inspection> button.  
The color inspection will begin.

4 The color inspection results are output as the color difference, registered data judgments, and overall results.

As the inspection target is the same as the inspection reference standard (data registration position), there is little color difference. As the color difference falls below the threshold value, a “PASS” judgment is output.

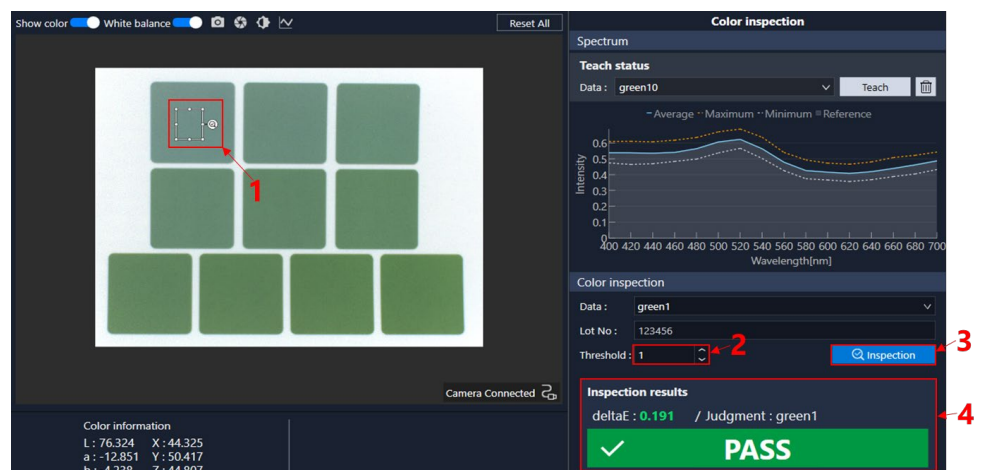

- (3) Perform a color inspection of the adjacent color patch.
  - 1 Place the search window over the adjacent color patch.
  - 2 Click the <Inspection> button to perform a color inspection.
  - 3 The inspection results will output “FAIL”. This is because the color difference (deltaE) exceeds the threshold value. The Judgment field calculates the color difference for all currently registered data, and displays the name of the teach data below the threshold value that has the smallest color difference. In this example, “green2” is displayed.

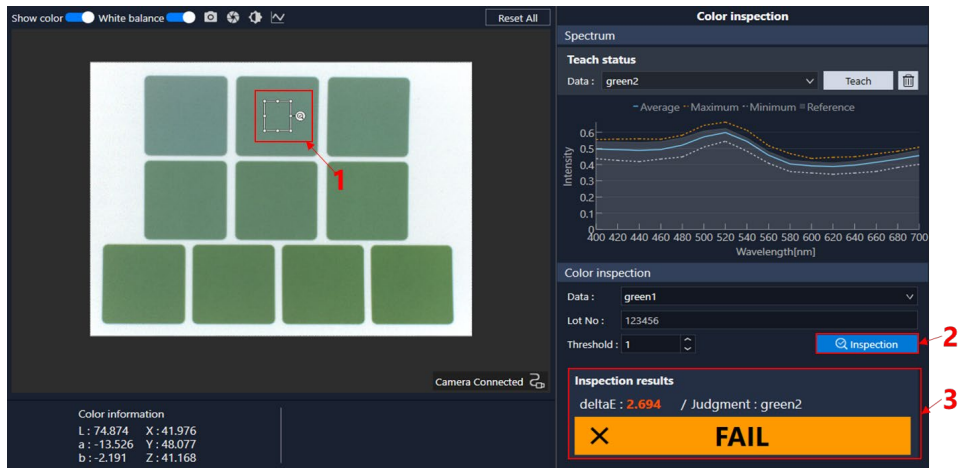

- (4) For example, performing a color inspection of an area that is not registered as data will return a “FAIL” result. The reason for this is that the color difference (deltaE) exceeds the threshold value, and the inspection target does not correspond to the registered data objects. The Judgment field calculates the color difference for all currently registered data, and displays the “Unknown” status if the inspection target has the smallest color difference but still exceeds the threshold.

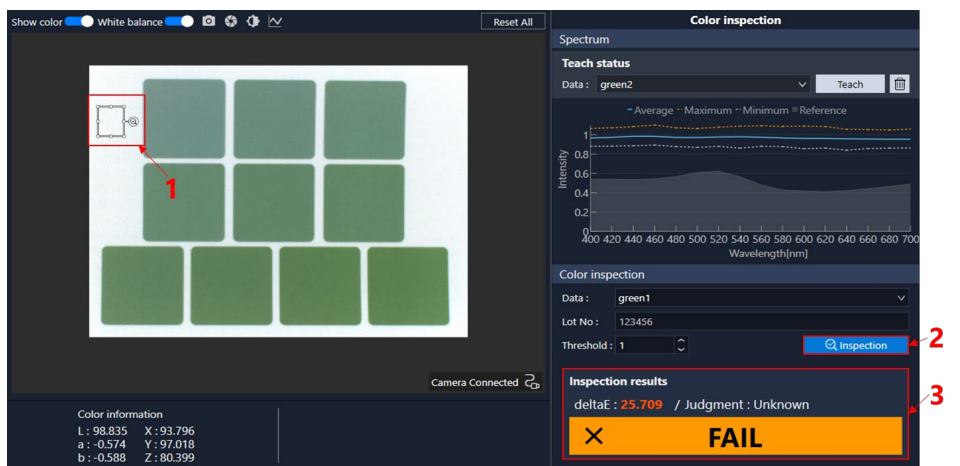

## 9.2.7 Per Pixel Color Inspection of Color Patches

The section on the “Color Inspection of Color Patches” provided a tutorial on color inspections concerning the average color information in a search window. This section provides a tutorial on micro color inspections by calculating the color difference in an image sensor on a per pixel basis. This section covers two functions, outputting micro-level color unevenness images (color difference heatmaps) on a per pixel level, and performing color inspections on a per pixel basis.

### 9.2.7.1 Reference Lab Configuration

To output a color difference heatmap and perform a color inspection on a per pixel basis, we need to set the reference Lab to calculate the color difference.

There are two ways to configure reference Lab settings: by specifying settings in the search window, or by clicking the 🎨 icon to directly enter the reference Lab value.

In this tutorial, we will set the reference Lab in the search window. For more information on how to directly enter the reference Lab value, refer to [7.3.1 Reference Lab Configuration](#).

Adjust the size of the search window, and move the search window to the color patch to use as the reference color for calculating the color difference as shown below. In this example, we will use the color patch in the upper left corner. The average Lab in the search window and the color difference per pixel are calculated when the size of the search window is adjusted or when the search window is moved. The color difference heatmap and binarized image will also update at the same time.

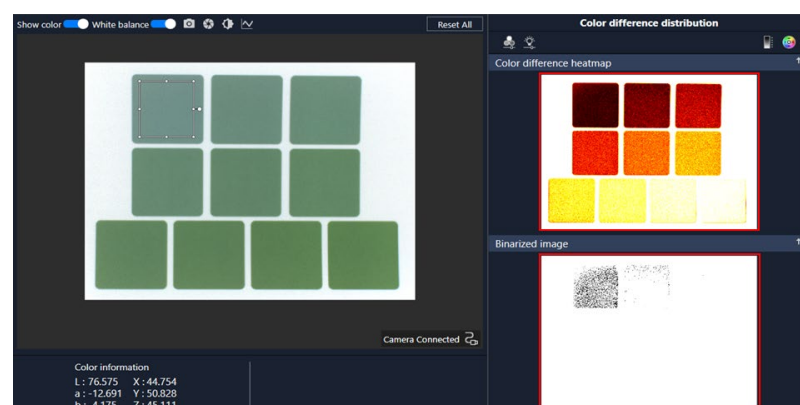
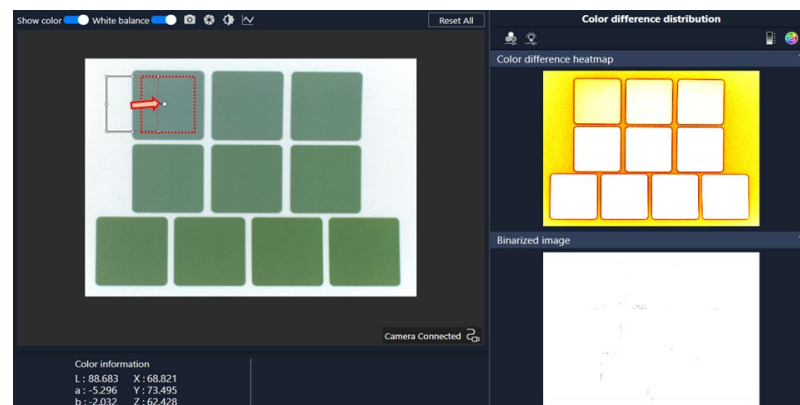

9.2.7.2 Identifying Micro-level Color Unevenness Using a Color Difference Heatmap  
Heatmap

This section describes the color difference heatmap, and the procedure for changing the image output. The following figure shows a color difference heatmap based on the upper left color patch.

The color difference heatmap is displayed in color. The darker the color, the smaller the color difference is. As the color patch in the upper left corner is used as the reference color, the color patch portion on the upper left corner appears darkest.

The chart measured applies a color gradient. We can see this in the color difference heatmap in how the corresponding color patches gradually become brighter.

This allows us to instantly identify color differences across the entire screen measured. We can also use this to detect color unevenness across the screen.

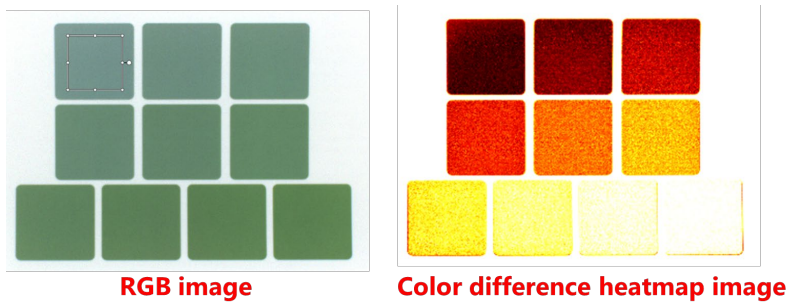

Click the  icon to display the relationship between the colors in the color difference heatmap and the color difference values.

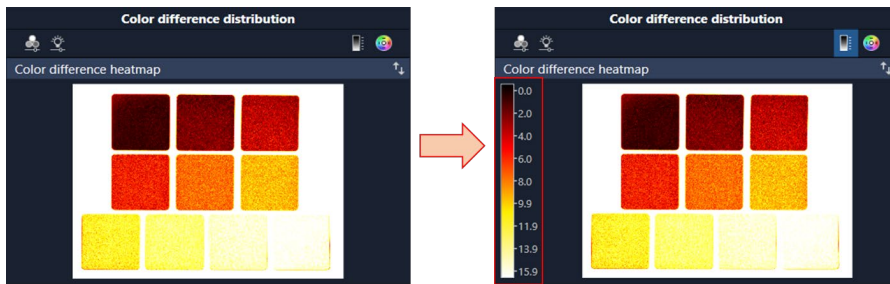

Here you can adjust the color and color difference value scale of the color difference heatmap.

- 1 Click the  icon.
- 2 This displays the track bar.
- 3 Change the track bar value.

Here you can adjust the color and color difference value scale. Increase the track bar value to expand the color range for color difference.

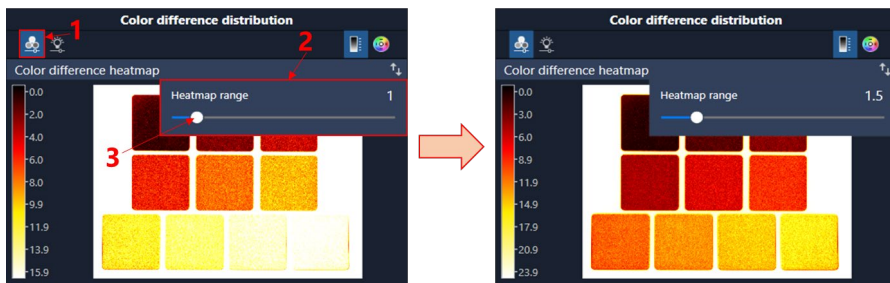

### 9.2.7.3 Per Pixel Color Inspection

This section describes binarized images, and the procedure to change threshold values.

First, to make it easy to compare the measurement image (preview image) and the binarized image, click the  icon to switch the position of the color difference heatmap and the binarized image.

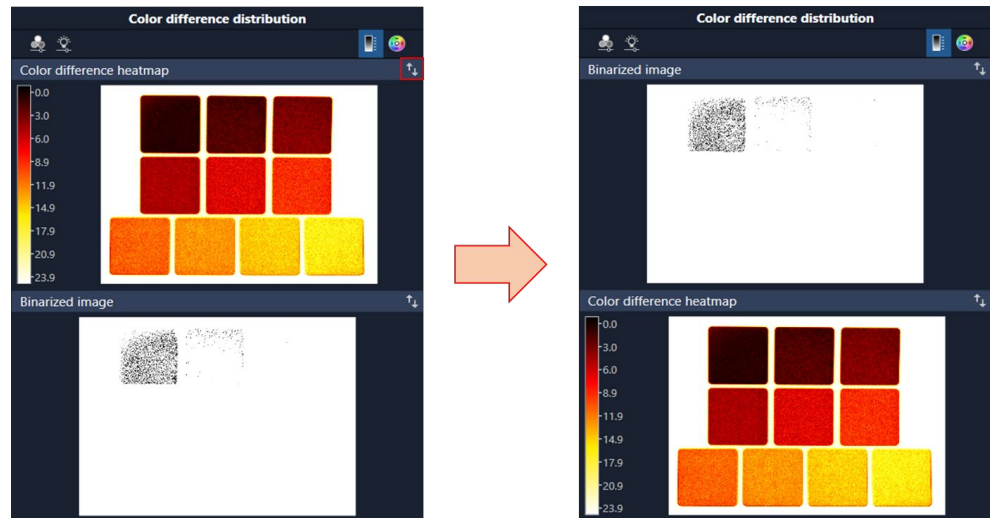

The following figure shows a binarized image based on the color patch in the lower right corner.

The binarized image is a monochrome image. If the color difference of each pixel is below the threshold, the corresponding pixel will be filled in black. If the color difference of each pixel is equal to or above the threshold, the corresponding pixel will be filled in white.

In this example, there are misjudged pixels filled in black outside the color patch specified as the reference color. This has occurred because the threshold value has not been set properly.

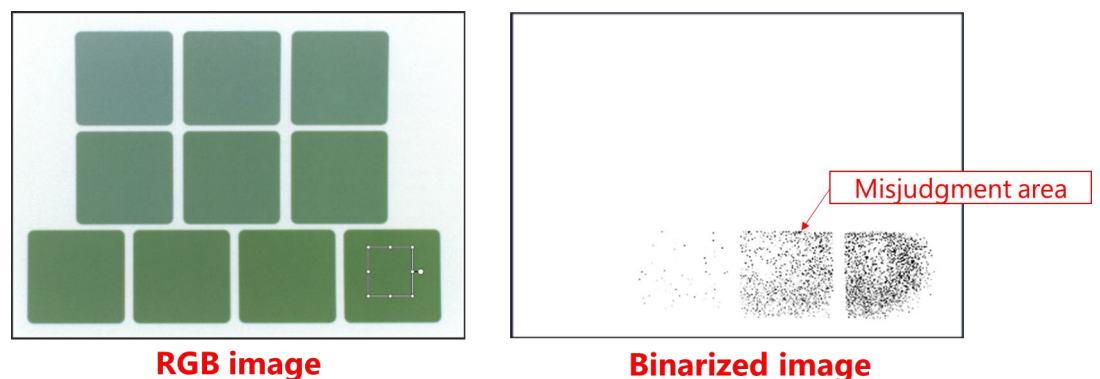

The following section describes the procedure to change the threshold value.

- 1 Click the  icon.
- 2 The panel will appear.
- 3 Change the position of the track bar in the panel.  
Use this to change the threshold value. The binarized image will update when the threshold value changes.

In this example, we need to set a smaller threshold value to eliminate these misjudgments. Set a threshold value that eliminates all misjudgments to obtain proper judgment results.

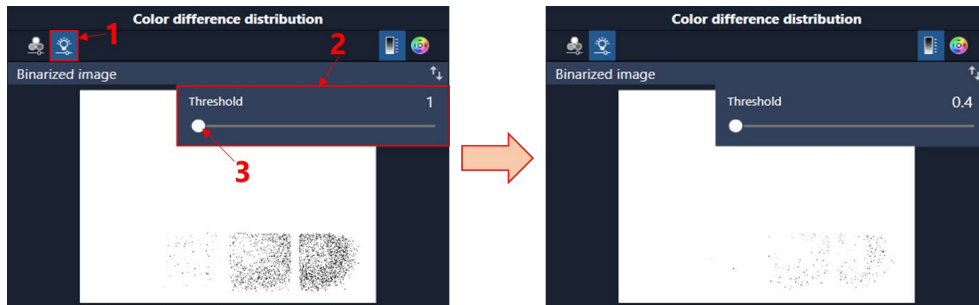

In an actual inspection, set the threshold value using a good limit sample and perform the above color inspection on a per lot basis to make PASS/FAIL judgments by confirming where the binarized image is filled in black.

## 9.3 Color Unevenness Inspection

### 9.3.1 Purpose and Measurement Configuration

This tutorial describes how to perform a macro-level color unevenness inspection by dividing the search window with a matrix. This is intended for detecting unevenness in prints, and unevenness in the coating of an automobile body frame, toys, and other such objects.

The color chart prepared for this tutorial has periodic shades of colors, and is intended for use in detecting printing and coating unevenness.

The following items are used in this tutorial.

#### Main products

- Spectroscopic Camera
- Spectroscopic Vision Controller
- USB 3.0 Spectroscopic Camera cable
- USB 2.0 Spectroscopic Camera cable

#### Optional products

- Camera tripod mount
- A/C adapter
- C-mount lens with 8 mm focal length (the optional lens: HF818-12M)

#### Items you should provide

- Camera stand
- Keyboard
- Mouse
- Monitor
- LED bar lighting
- White plate (white paper in this example)

The figure below is a color chart used in the tutorial. Print it in A4 size / color, and cut the margins before using it.

As this is the tutorial for a color unevenness inspection, make sure to perform a nozzle check and confirm that your printer is printing properly. You need to do this because, if the printer nozzles are clogged, printing unevenness may also occur in normal color patterns.



Normal color pattern



Color pattern with uneven color



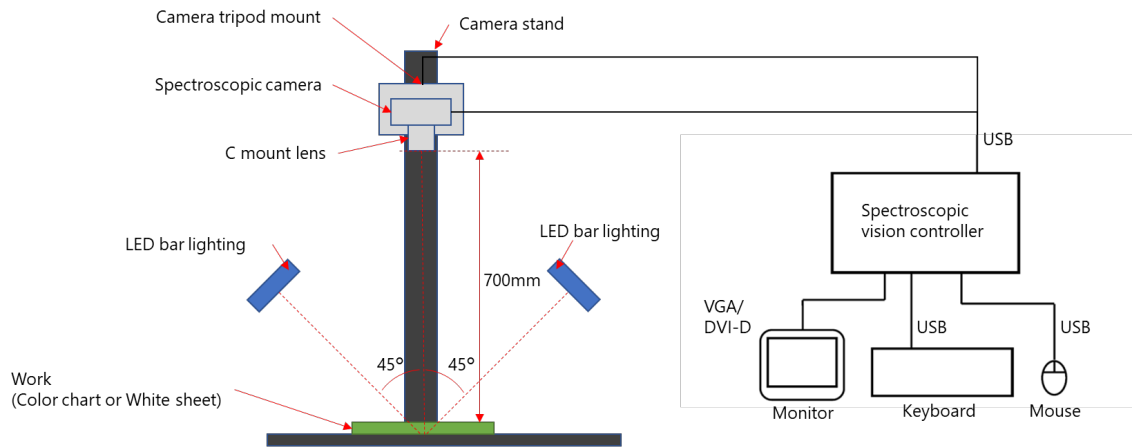

Measurement configuration for color unevenness inspection

Lighting is required to measure the color reflected off the target. When measuring tiles with a flat and glossy surface, place the lighting at a 45° angle to the workpiece in order to prevent specular reflection due to gloss. If it is placed on only one side, uneven lighting and shadows will be created when recognizing the shape of the tile. So, it is configured to illuminate at a 45° angle from both sides. The field of view of measurement is determined by the working distance (the distance from the tip of the lens on the Spectroscopic Camera to the measurement workpiece), the resolution of the Spectroscopic Camera, and the focal length of the lens.

- Working distance: 700 mm
- Spectroscopic camera resolution: 1024 x 768
- C-mount lens with 8 mm focal length (the optional lens: HF818-12M)

### 9.3.2 Start Epson SV Tools and Create a New Project

Refer to the following section for how to start Epson SV Tools and create a new project.

#### 9.2.2 Start Epson SV Tools and Create a New Project

### 9.3.3 Measurement for White Balance

Refer to the following section to perform a measurement for white balance.

#### 9.2.3 Measurement for White Balance

### 9.3.4 Measurement for Spectrum

Refer to the following section to perform a measurement for spectrum.

#### 9.2.4 Measurement for Spectrum of Color Patches

The two measurement targets of this tutorial are a “normal color pattern” and an “uneven color pattern”.

### 9.3.5 Color Unevenness Inspection

This section describes the color unevenness inspection process for measurement for spectrum using a “normal color pattern” and an “uneven color pattern”.

- (1) Load the “normal color pattern” measurement results.  
Once loaded, adjust the size and position of the search window, and then place it over the color unevenness inspection area.

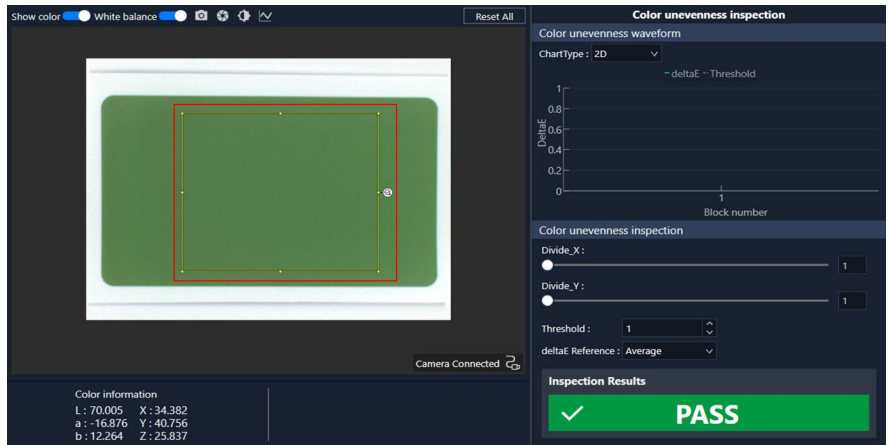

- (2) 1 Specify the number of divisions in the search window for color unevenness inspection.  
Set the number of divisions in the width and height directions using Divide\_X and Divide\_Y values, respectively.  
When changing the number of divisions, the number of divisions shown in the search window 2 and the color unevenness waveform graph 3 will update simultaneously.  
In this example, Divide\_X is set to 50, and Divide\_Y is set to 4. We have increased the number of divisions in the width direction as we are focusing on inspecting the unevenness in vertical lines.

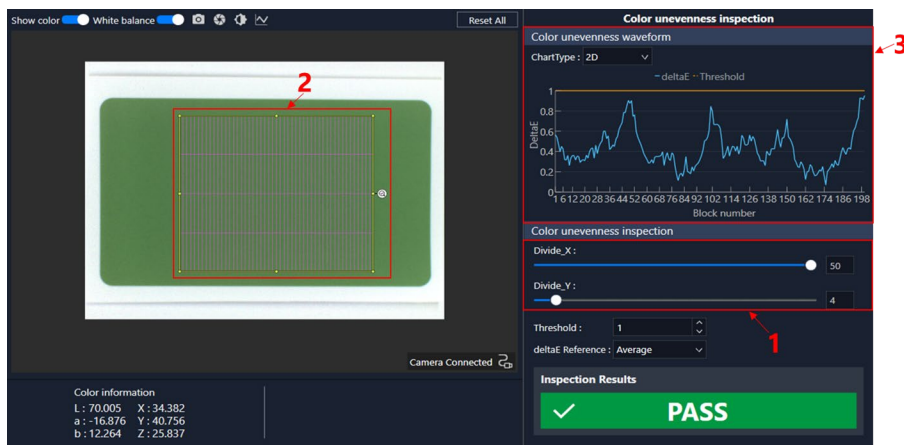

The color difference of each block in a color unevenness waveform is calculated based on the average color information in the search window. Reference color information can be set with the [deltaE Reference] setting. You can also set this to any value from a divided block. In this example, “Average” (average color information in the search window) is selected.

The threshold value for the color unevenness inspection can be set in the [Threshold] field. In this example, the threshold is set to 1.

As the workpiece in this example is a “normal color pattern” with little color unevenness, the color difference values for each block all fell below the threshold value, and a “PASS” judgment is output.

(3) Perform a color unevenness inspection using an “uneven color pattern”.

Set the same inspection conditions as the conditions used for the “normal color pattern”. The results of the color unevenness inspection are shown below. When the color difference in the divided blocks is equal to, or exceeds the threshold, the border frame of the corresponding block is displayed in orange. This provides a visual indication of where there is a large unevenness in color. The color unevenness waveform pattern also shows a large color difference in the line unevenness part. You can see the unevenness of the vertical lines in the color difference shown periodically. You can change the color unevenness waveform graph from 2D to 3D to easily compare the uneven part of the sample.

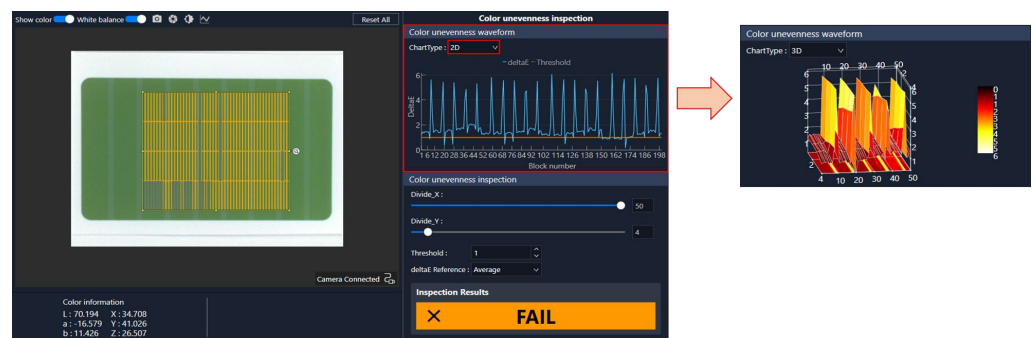

## 9.4 Spectrum Distinction of Lace Fabric

### 9.4.1 Purpose and Measurement Configuration

This tutorial describes how to identify consistencies in the spectral shape with the image spectrum on a per-pixel basis based on a pre-registered spectral data group. Due to the large volume of spectral information compared to color information, this inspection process allows for greater precision compared to using color information. However, the spectral shape is not suited for correlating visual inspections as inspection information is not provided in the form of color information visible to the human eye, such as when using Lab. It is an effective tool to use for detecting minor differences that are difficult to visually identify with the human eye.

The following items are used in this tutorial.

#### Main products

- Spectroscopic Camera
- Spectroscopic Vision Controller
- USB 3.0 Spectroscopic Camera cable
- USB 2.0 Spectroscopic Camera cable

#### Optional products

- Camera tripod mount
- A/C adapter
- C-mount lens with 12 mm focal length (optional lens: HF1218-12M)

#### Items you should provide

- Camera stand
- Keyboard
- Mouse
- Monitor
- LED bar lighting
- White plate (white paper in this example)

The following figure shows the lace fabric used in this tutorial.

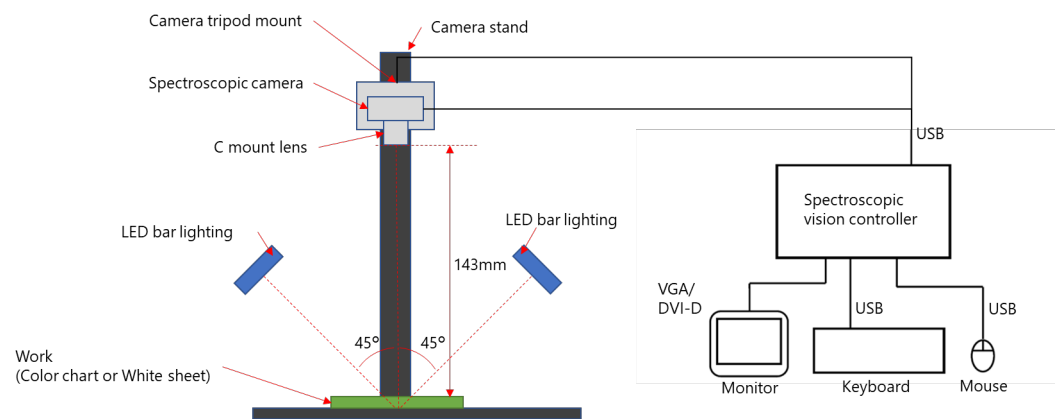
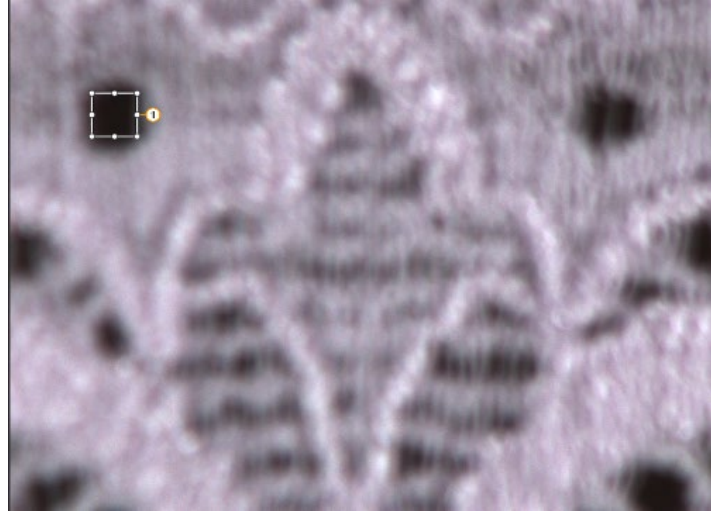

Measurement configuration of lace fabric

The reflectivity of clothing, lace, and other fabric products changes according to the direction of the fabric weave, and the direction of the lighting. Lighting the fabric in parallel to the direction of the weave will reduce diffuse reflection, and lower reflectivity. Conversely, lighting the fabric perpendicular to the direction of the weave will increase diffuse reflection.

As light comes from a single direction in a light source booth used for visual evaluation, there is no diffuse reflection similar to that produced by dome lighting. Instead, this results in a  $45^\circ$  illumination/ $0^\circ$  light reception configuration that produces a difference in reflection due to the weave. The lighting is setup to come from two directions. This is to eliminate shadows caused by the three-dimensional structure of the fabric. The field of view of measurement is determined by the working distance (the distance from the tip of the lens on the Spectroscopic Camera to the measurement workpiece), the resolution of the Spectroscopic Camera, and the focal length of the lens.

- Working distance: 143 mm
- Spectroscopic camera resolution: 1024 x 768
- C-mount lens with 12 mm focal length (optional lens: HF1218-12M)

### 9.4.2 Start Epson SV Tools and Create a New Project

Refer to the following section for how to start Epson SV Tools and create a new project.

#### 9.2.2 Start Epson SV Tools and Create a New Project

### 9.4.3 Measurement for White Balance

Refer to the following section to perform a measurement for white balance.

#### 9.2.3 Measurement for White Balance

### 9.4.4 Measurement for Spectrum

Refer to the following section to perform a measurement for spectrum.

#### 9.2.4 Measurement for Spectrum of Color Patches

### 9.4.5 Spectrum Distinction

#### 9.4.5.1 Data Registration

- (1) As shown in the figure below, data is registered in three locations in total: 1 the weave of the fabric (Glossy Part), 2 the weave of the fabric (Bright Part), and 3 the background (Dark Part).

Each part is described in order below.

- 1 weave of the fabric (Glossy Part), 2 weave of the fabric (Bright Part),
- 3 background (Dark Part)

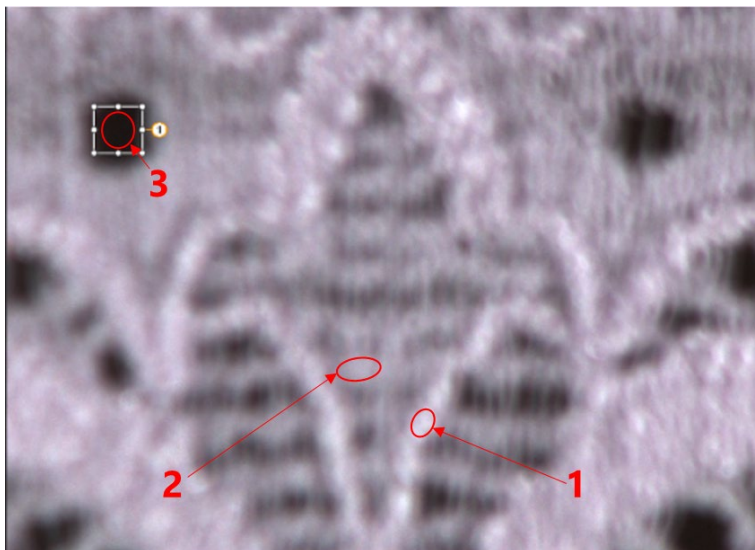

## (2) Register data for the weave of the fabric (Glossy Part).

- 1 Enlarge the preview image to a magnification of 300% to make it easier to pinpoint the position of the weave of the fabric (Glossy Part) in the search window.
- 2 Place the search window over the weave of the fabric (Glossy Part).
- 3 Click the ① icon to display the data registration panel.  
Register the data.
- 4 In the [Name] field, enter the name. (In this tutorial, we enter “COLOR1”.)
- 5 Click the <Screen Teach> button.

This ends the data registration process for the weave of the fabric (Glossy Part).

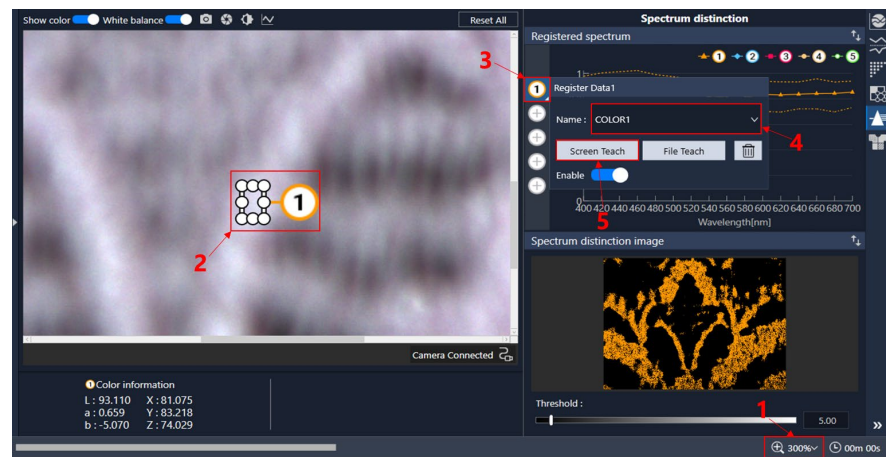

## (3) Register data for the weave of the fabric (Bright Part).

- 1 Place the search window over the weave of the fabric (Bright Part).
- 2 Click the ② icon to display the data registration panel.  
Register the data.
- 3 In the [Name] field, enter the name. (In this tutorial, we enter “COLOR2”.)
- 4 Click the <Screen Teach> button.

This ends the data registration process for the weave of the fabric (Bright Part).

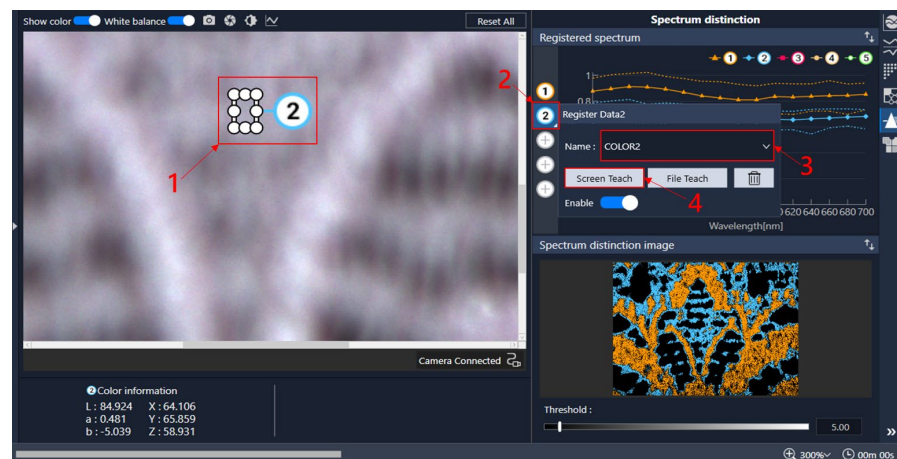

(4) Register data for the background (Dark Part).

1 Place the search window over the background (Dark Part).

2 Click the **3** icon to display the data registration panel.

Register the data.

3 In the [Name] field, enter the name. (In this tutorial, we enter “background”.)

4 Click the <Screen Teach> button.

This ends the data registration process for the background (Dark Part).

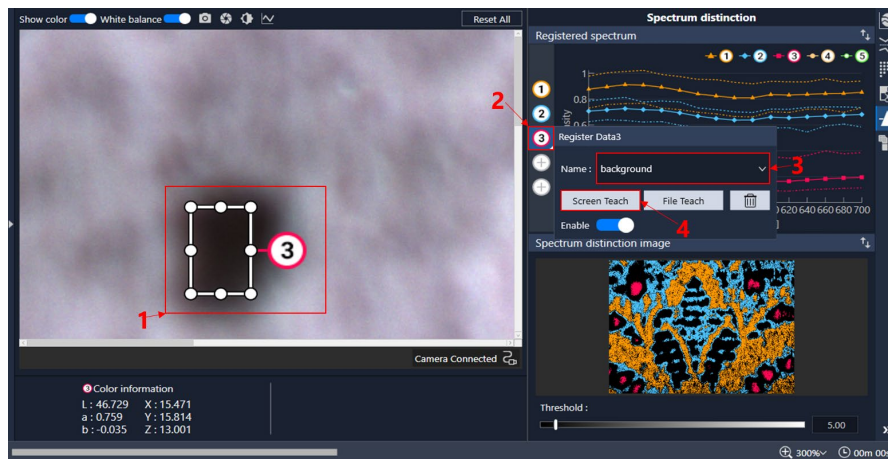



### 9.4.5.2 Setting Threshold Values

The judgment threshold value must be adjusted to output accurate judgment images in relation to the actual image.

Adjust the position of the judgment image to easily compare the measurement image and the judgment image. Click the  icon to switch the position of the judgment image and the registered spectral graph.

Place the mouse cursor over the boundary between the judgment image and the registered spectrum to change the cursor to , and then click and drag the cursor down to enlarge the judgment image.

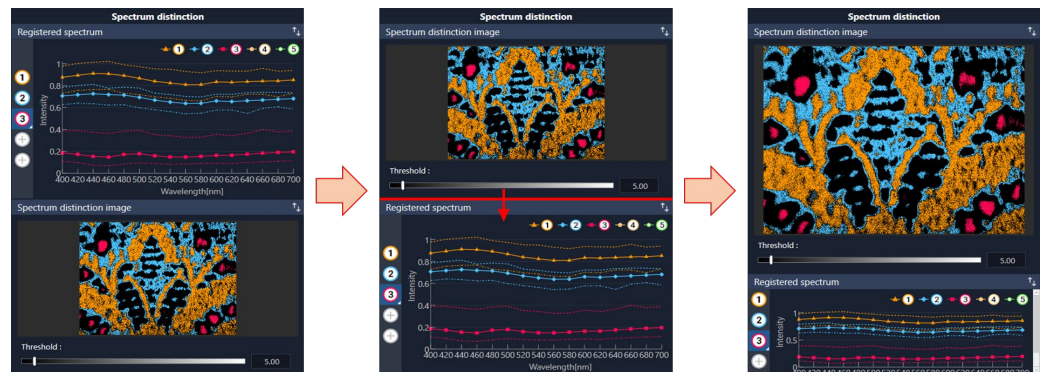

Reducing the threshold value to set a stricter judgment criteria will limit the area rendered in color. If the area rendered in color is too small in the judgment image, increase the threshold value to relax the judgment criteria and increase the area rendered in color. Note that increasing the threshold value too much will result in judgment errors. Therefore, set the threshold value while comparing the measurement image and the judgment image.

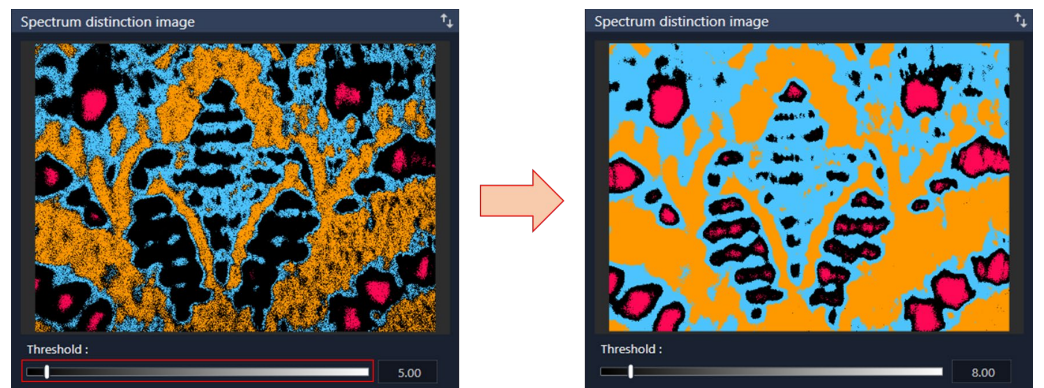

## 9.5 Fabric Color Inspection

### 9.5.1 Purpose and Measurement Configuration

This tutorial describes how to inspect colors in clothing, lace, and other fabrics. Clothing, lace, and other such products have highly uneven surfaces, resulting in areas that are reflected as fiber colors, and areas in shadow due to the effect of the weave. In a color inspection, color information is averaged in the search window. A specific color cannot be obtained because the color of the fiber is mixed in with the shadow from the weave and the background color. In this tutorial, individual colors within the color inspection range can be extracted because the color of the fiber, the color of the shadow from the weave, and the background color are registered individually. This inspection can also be used for color inspections of a specific color, regardless of the fabric, by removing certain colors, such as the background color.

The following items are used in this tutorial.

#### Main products

- Spectroscopic Camera
- Spectroscopic Vision Controller
- USB 3.0 Spectroscopic Camera cable
- USB 2.0 Spectroscopic Camera cable

#### Optional products

- Camera tripod mount
- A/C adapter
- C-mount lens with 12 mm focal length (optional lens: HF1218-12M)

#### Items you should provide

- Camera stand
- Keyboard
- Mouse
- Monitor
- LED bar lighting
- White plate (white paper in this example)

The following figure shows the lace fabric used in this tutorial.

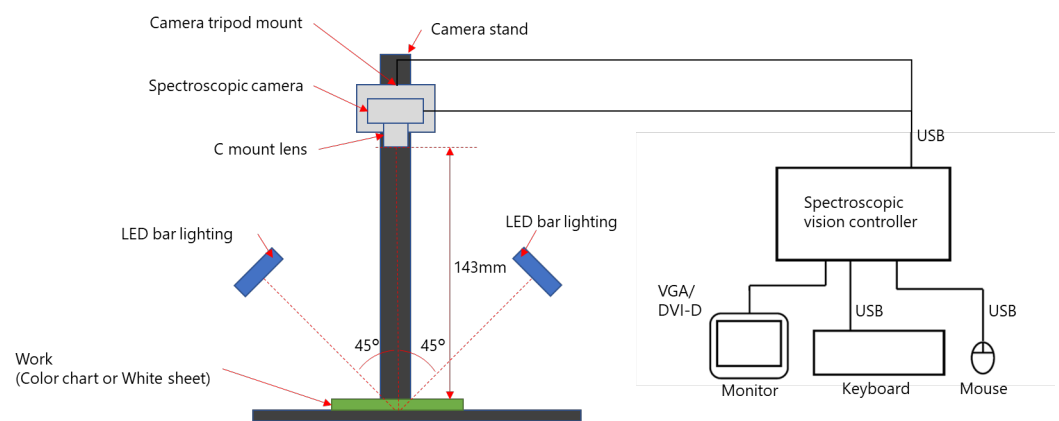
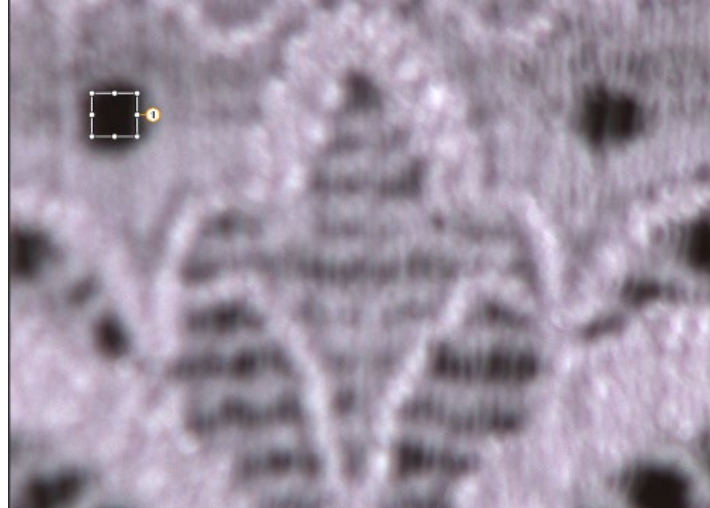

Measurement configuration of fabric color inspection

The reflectivity of clothing, lace, and other fabric products changes according to the direction of the fabric weave, and the direction of the lighting. Lighting the fabric in parallel to the direction of the weave will reduce diffuse reflection, and lower reflectivity. Conversely, lighting the fabric perpendicular to the direction of the weave will increase diffuse reflection. As light comes from a single direction in a light source booth used for visual evaluation, there is no diffuse reflection similar to that produced by dome lighting. Instead, this results in a  $45^\circ$  illumination/ $0^\circ$  light reception configuration that produces a difference in reflection due to the weave. The lighting is setup to come from two directions. This is to eliminate shadows caused by the three-dimensional structure of the fabric. The field of view of measurement is determined by the working distance (the distance from the tip of the lens on the Spectroscopic Camera to the measurement workpiece), the resolution of the Spectroscopic Camera, and the focal length of the lens.

- Working distance: 143 mm
- Spectroscopic camera resolution: 1024 x 768
- C-mount lens with 12 mm focal length (optional lens: HF1218-12M)

## 9.5.2 Start Epson SV Tools and Create a New Project

Refer to the following section for how to start Epson SV Tools and create a new project.

### 9.2.2 Start Epson SV Tools and Create a New Project

## 9.5.3 Measurement for White Balance

Refer to the following section to perform a measurement for white balance.

### 9.2.3 Measurement for White Balance

## 9.5.4 Measurement for Spectrum

Refer to the following section to perform a measurement for spectrum.

### 9.2.4 Measurement for Spectrum of Color Patches

## 9.5.5 Fabric Color Inspection

### 9.5.5.1 Data Registration

- (1) Before performing the fabric color inspection, it is necessary to specify search area for each of the ① Bright Part, ② Dark Part, and the ③ Glossy Part and register the data.

This tutorial describes the data registration process.

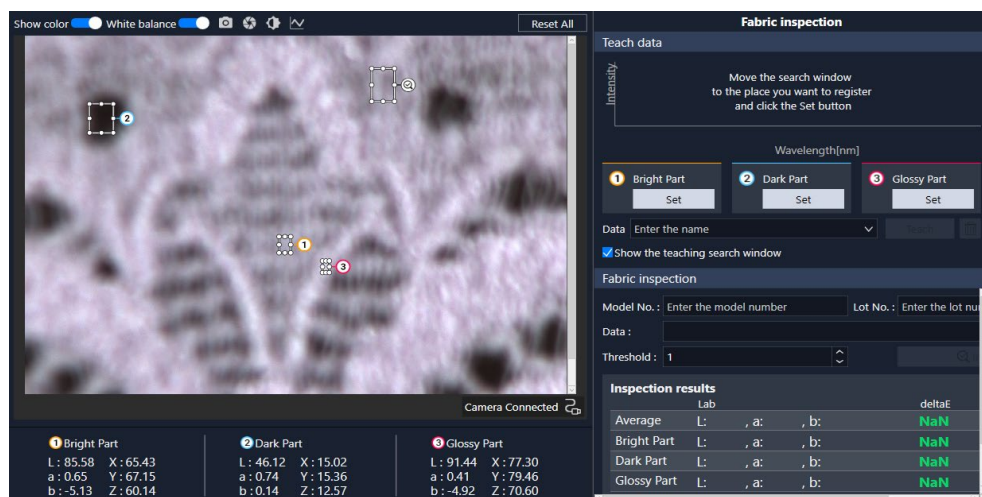

- (2) Match the three search windows for the ① Bright Part, ② Dark Part, and ③ Glossy Part to the areas you want to register data for.

Due to the small size of each area, enlarge the preview image before placing each search window.

1 Place each search window.

2 Click the <Set> button.

This sets the data.

3 Enter the data registration name. (In this tutorial, “fabric\_test” is used.)

4 Click the <Teach> button.

This ends the data registration process.

The screenshot displays the software interface for fabric inspection. On the left, a camera feed shows a fabric texture with three search windows (1, 2, 3) overlaid. Below the camera feed, a table lists the coordinates for each search window:

| Search Window | L     | X     | a    | Y     | b     | Z     |
|---------------|-------|-------|------|-------|-------|-------|
| ① Bright Part | 85.58 | 65.43 | 0.65 | 67.15 | -5.13 | 60.14 |
| ② Dark Part   | 46.12 | 15.02 | 0.74 | 15.36 | 0.14  | 12.57 |
| ③ Glossy Part | 91.44 | 77.30 | 0.41 | 79.46 | -4.92 | 70.60 |

On the right, the 'Fabric inspection' panel shows a 'Teach data' graph of Intensity vs. Wavelength (nm). Below the graph, there are three 'Set' buttons for the search windows, a 'Data' dropdown set to 'fabric\_test', and a 'Teach' button. The 'Inspection results' table shows the following data:

| Inspection results | Lab          | deltaE |
|--------------------|--------------|--------|
| Average            | L: , a: , b: | NaN    |
| Bright Part        | L: , a: , b: | NaN    |
| Dark Part          | L: , a: , b: | NaN    |
| Glossy Part        | L: , a: , b: | NaN    |

## 9.5.5.2 Fabric Inspection

- (1) To perform a color inspection, enter 1 Model No., 2 Lot No., and 3 Data fields. Once complete, the <Inspection> button will become available, and you will be able to perform a color inspection.

## 1 Model No.

Enter the Model No. Any character string is acceptable.

In this tutorial, “CL-100-135-B” is used.

## 2 Lot No.

Enter the lot number. Any alphanumeric character string is acceptable.

In this tutorial, “123456” is used.

## 3 Data

Select the data registered as an inspection reference standard from the list.

In this tutorial, “fabric\_test” is used.

Fabric inspection

Model No.: CL-100-135-B Lot No.: 123456

Data: fabric\_test

Threshold: 1

Inspection

| Inspection results |                  | deltaE | ratio |
|--------------------|------------------|--------|-------|
| Average            | Lab L: , a: , b: | NaN    | NaN   |
| Bright Part        | L: , a: , b:     | NaN    | NaN   |
| Dark Part          | L: , a: , b:     | NaN    | NaN   |
| Glossy Part        | L: , a: , b:     | NaN    | NaN   |

- (2) After entering the three fields above, perform the following:
- 1 Adjust the size of the search window, and place it over the inspection area. In this tutorial, we will place it in the same position as the color patch we registered data for (upper left corner).
  - 2 Set the inspection threshold. In this example, the threshold is set to 1.0.
  - 3 Click the <Inspection> button. The color inspection will begin.
  - 4 Once the color inspection is complete, the four types of color information (Lab), the color difference to the registered data, and the extraction ratio for the Bright Part, Dark Part, and the Glossy Part, and the average of the Bright Part, Dark Part, and the Glossy Part. These results will vary according to the data registration area and the inspection position. As the color difference of the Bright Part, Dark Part, Glossy Part, and the average all fall below the threshold value for registered data, a “PASS” judgment is output.

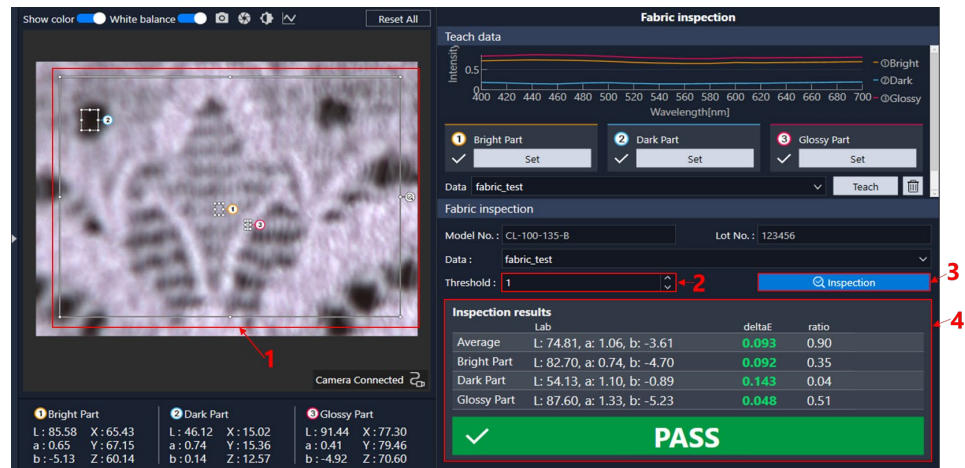

Further, although it has no direct influence on PASS/FAIL judgments, the ratio indicator is also provided. The ratio shows the degree to which registered parts are found in the inspection area.

The higher the ratio, the greater the amount of registered data is detected, leading a greater degree of reliability to the Lab and color difference data values.

Conversely, the lower the ratio, the lower the data reliability, even in cases where there is only a small degree of color difference. In this example, the ratio is 14% for the Bright Part, 5% for the Dark Part, and 81% for the Glossy Part. The average ratio is the sum of the Bright Part, Dark Part, and the Glossy Part, so in this example it is 99%. Here, 99% of the total image has been extracted, and the data is considered to have a high degree of reliability.

In actual PASS/FAIL judgment inspections, all four data types, namely the Bright Part, Dark Part, Glossy Part, and the average, do not need to be below the threshold value. For example, when prioritizing overall color inspections using a visual inspection, a judgment can be made using the average value alone. Judgments can also be made using the part with the largest extraction ratio. It is important to align these judgments with points of focus for visual inspections performed by the customer.

## 10. Troubleshooting

### 10.1 Error Messages

|                                    | Error message  | Solution   |
|------------------------------------|--|--|
| On startup                         | The Epson SV Tools is already running.   | You cannot run multiple instances of the Epson SV Tools software.  |
|                                    | The effectiveness of the spectroscopic vision function could not be confirmed. Please enable it from the Option for Spectroscopic. | Check that the option setting for spectroscopic vision system has been activated.                                |
| Camera-related                     | There is no response from the camera. Disconnect the camera.   | Check the connection between the USB cable and the Spectroscopic Camera, or the Spectroscopic Vision Controller. |
| Measurement                        | It could not be measured due to strong lighting.<br>Reduce the amount of lighting.   | Reduce the amount of lighting.<br>Reference: Use the minimum exposure time that avoids halation in the preview.  |
| Analysis processing                | Analysis processing failed.  | Internal error<br>Restart the Controller.  |
|                                    | The following data is corrupted and should be deleted or re-taught.  | The data is corrupted and should be deleted or re-taught.  |
| Save analytical data               | Please perform the test before saving the analysis data.   | Please perform the test before saving the analysis data.   |
|                                    | The save file name has not been set.   | Please enter the name of the save data.  |
|                                    | Please read the measurement data.  | Please read the measurement data.  |
| Data name entry and data selection | Please enter name.   | Please enter name.   |
|                                    | Please select a data.  | Please select a data.  |
|                                    | The name should be 40 characters or less.  | The name should be 40 characters or less.  |
|                                    | The following characters can not be used for data name<br>\\/: * ? " < >   | Do not use the prohibited characters shown in the error message.   |
|                                    | The following characters can not be used for project name<br>\\/: * ? " < >  | Do not use the prohibited characters shown in the error message.   |
|                                    | The data is corrupted.<br>Please select another data.  |  |
| Data file operation                | No data was found.<br>Select another data or try Teach again.  | Select another data or try Teach again.  |
|                                    | Please set the project name.   | Please set the project name.   |
|                                    | Please enter the file name   | Please enter the file name   |
|                                    | No measurement data was found.   | Reperform the measurement.   |
|                                    | No data was found.   | Please register the data.  |



|           | Error message  | Solution  |
|-----------|--|---|
|           | No data was found.<br>Please register the data.  | Please register the data.   |
|           | The process could not be completed.<br>Please make sure the files in the data folder are not open. | Check that data in the data folder are not open.  |
|           | Failed to read the measurement data.   |   |
|           | The manual was not found.  | The manual may have been deleted.<br>Reinstall the software to create a new manual.<br>Further, the manual is only provided with the Japanese language version. Changing the language setting to English will not display the manual. |
|           | The manual could not be opened.  |   |
|           | This data is registered with the following number and cannot be taught or deleted.                 |   |
| Snapshots | Start the preview or load measurement data.  | Start the preview or load measurement data.   |

## 10.2 The Spectroscopic Vision Controller Does Not Recognize the Spectroscopic Camera

If the Spectroscopic Vision Controller does not recognize the Spectroscopic Camera, either the USB cable has not been properly connected, or the EPSON RC+ software is running and the Spectroscopic Camera is already in use.

If the EPSON RC+ software is running and the Spectroscopic Camera is already in use, close the EPSON RC+, and then confirm the following.

If the USB cable has not been properly connected, remove and reconnect the USB cable, and then check the connection again.

Checking using Epson SV Tools:

- Connect the Spectroscopic Camera and the Spectroscopic Vision Controller using both USB 2.0 and USB 3.0 cables.
- Start Epson SV Tools.
- Once started, a “Connecting the camera” message will appear, as shown in the figure below.

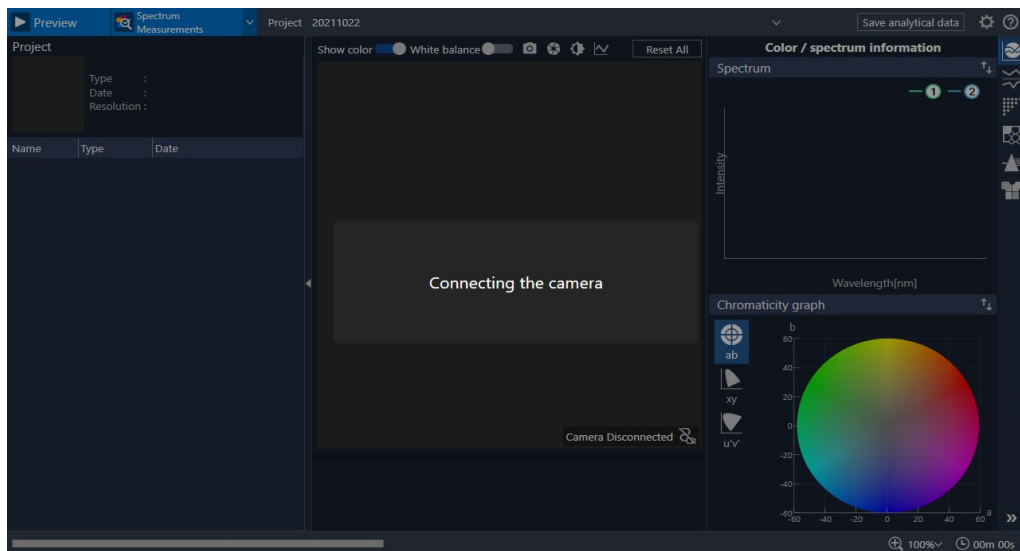

Once the connection procedure for the Spectroscopic Camera is complete, the “Camera/Disconnected” status will change to the “Camera/Connected” status as shown in the image below. The connection icon will also change at the same time.

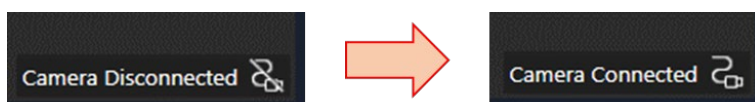

## Checking using Device Manager:

If both of the following appear, the connection status is normal.

- “DMM 27UJ003-ML” appears as the imaging device
- “USB serial device (COM\*\*)” appears under Ports (COM and LPT)

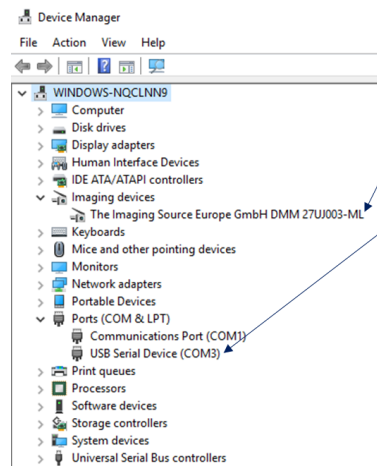

Shown when a USB3.0 cable is connected.  
A device that manages shooting functions.

Shown when a USB2.0 cable is connected.  
A device that manages the spectroscopic function.

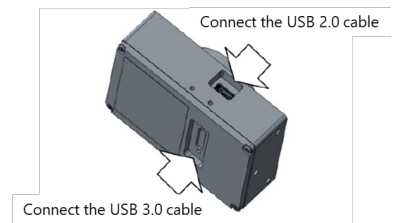

## 11. Trial Mode

### 11.1 Overview

Even when the license is not setup, you can use Epson SV Tools in trial mode. In trial mode, you cannot use the following functions.

- Connecting Spectroscopic Camera
- Saving analytical data
- Discarding teach data

To analyze, use a sample project. For details, refer to "*Appendix B: Sample Projects.*"

### 11.2 Connecting Spectroscopic Camera

In trial mode, even when you connect Spectroscopic Camera, the camera is not regarded as connected. You cannot use the following functions which need the connection of Spectroscopic Camera.

- Preview
- Measurement for spectrum
- Measurement for white balance
- Snapshot

### 11.3 Discarding Registered Data

In trial mode, the registered data will be discarded when you close Epson SV Tools. You cannot use the registered data at the next boot of Epson SV Tools. The registered data of a color inspection, a spectrum distinction, and a fabric inspection will be discarded.

On the teach status window, the following message appears.

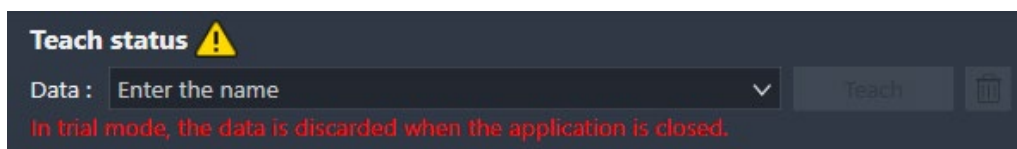

# Appendix



## Appendix A: Various Approximate Formulas for Lens

When the WD (Working Distance) is generally greater than 200 mm,

Distance to a subject:  $L$  [mm]

Focal length:  $f$  [mm]

### Approximate formula of field of view (height)

$$H = L \times \text{CCD vertical dimension} / f$$

\* CCD vertical dimension = pixel size  $\times$  pixels

\* For pixel size, refer to the specifications of each camera.

When the WD is generally 200 mm or less,

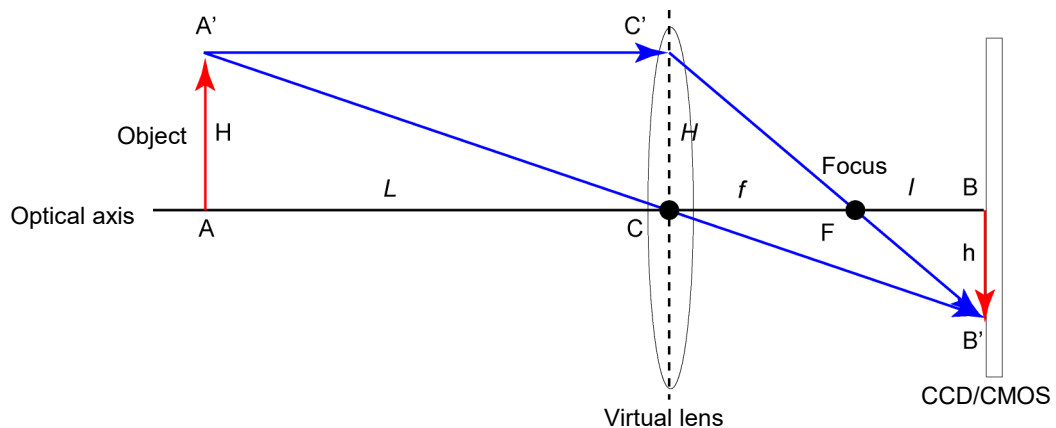

Distance to a subject:  $L$

Focal length:  $f$

Distance from focal point to image sensor:  $l$

Distance from virtual lens to image sensor (CCD/CMOS):  $(f+l)$

### Tips

“Distance to a subject:  $L$ ” in the figure above is different from the working distance “ $WD$ ”.

“Distance to a subject:  $L$ ” is the distance from “Virtual lens position”. The working distance “ $WD$ ” is the distance from “Lens edge” to the subject.

The relation between  $L$ ,  $(f+l)$  and  $WD$  in the figure above is as follows:

$$L + (f + l) = WD + \text{lens length} + 17.526\text{mm}$$

**Distance ( $f + l$ ) from virtual lens to image sensor (CCD/CMOS)**

$$(f + l) = (L \times f) / (L - f)$$

**L with extension tube ( $t$ )**

$$L = f \times ((f + l) + t) / (((f + l) + t) - f)$$

**Approximate formula of field of view (height)**

$$H = L \times \text{CCD vertical dimension} / (f + l)$$

\* CCD vertical dimension = pixel size  $\times$  pixels

\* For pixel size, refer to the specifications of each camera.



## Appendix B: Sample Projects

Sample projects are in the following folders:

\EpsonSVTools\Samples (installation destination of Epson SV Tools)

Within the sample projects, there is the measurement data for each tutorial. You can use the measurement data for color inspection and analysis of the tutorial.

The following four folders are for the sample projects. When analyzing using this sample projects, move or copy the analyzed project folder set to the following folder.

\EpsonSVTools\Results\Projects (installation destination of Epson SV Tools)

### 9.2 Color Patch Color/Spectrum Information and Color Inspection

Project name: ColorInspection

Spectrum data : ColorChart1\_20210531081905 (Green)  
 ColorChart2\_20210531083137 (Red)  
 ColorChart3\_20210531083231 (Beige)

White balance data : white13\_20210531081534

### 9.3 Color Unevenness Inspection

Project name: UnevennessInspection

Spectrum data : Mura\_20210531083641 (With unevenness)  
 NoMura\_20210531083546 (No unevenness)

White balance data : WhiteMura\_20210531083444

### 9.4 Spectrum Distinction of Lace Fabric

Project name: SpectrumDistinction

Spectrum data : Fabric1\_20210531090309 (Data for teaching)

White balance data : white\_fabric\_20210531090031

### 9.5 Fabric Color Inspection

Project name: FabricInspection

Spectrum data : Fabric1\_20210531090309 (Data for teaching)  
 Fabric2\_20210531091535 (Data for inspection)

White balance data : WhiteFabric\_20210531090031

## Appendix C: Open Source Software License Agreement

In addition to the software for which EPSON holds the rights, this product also uses open source software.

Information about the open source software used in this product is provided below.

EPSON uses open source software for this product in accordance with the terms presented by the copyright holder of the open source software (listed in the full license agreement).

Due to the nature of open source software, EPSON provides no warranty regarding open source software. However, this shall have no effect on any warranty provided by EPSON regarding defects in this product (including defects that are caused by the open source software).

The full text of the license agreement can be found in the following folder.

`\EpsonSVTools\OSSLicenses` (installation destination of Epson SV Tools)

## Appendix D: Other

The software below is used to a part of this product.

ComponentOne

Copyright (C) 2004 GrapeCity Inc.

