

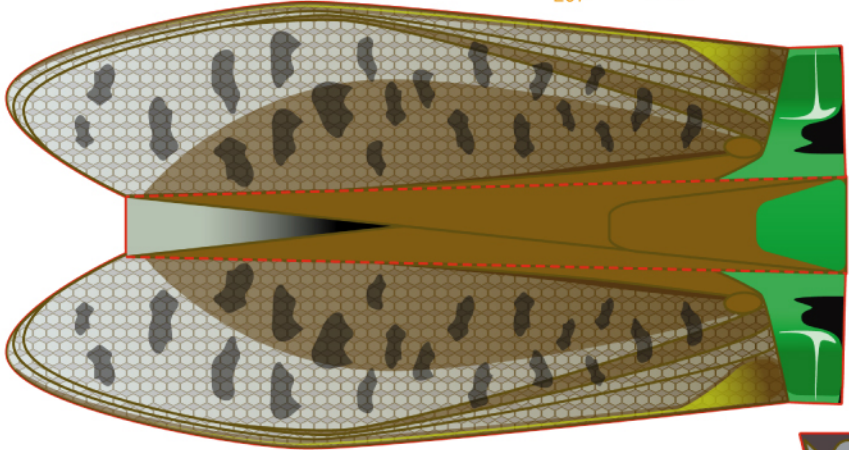

翅膀

L07



L06

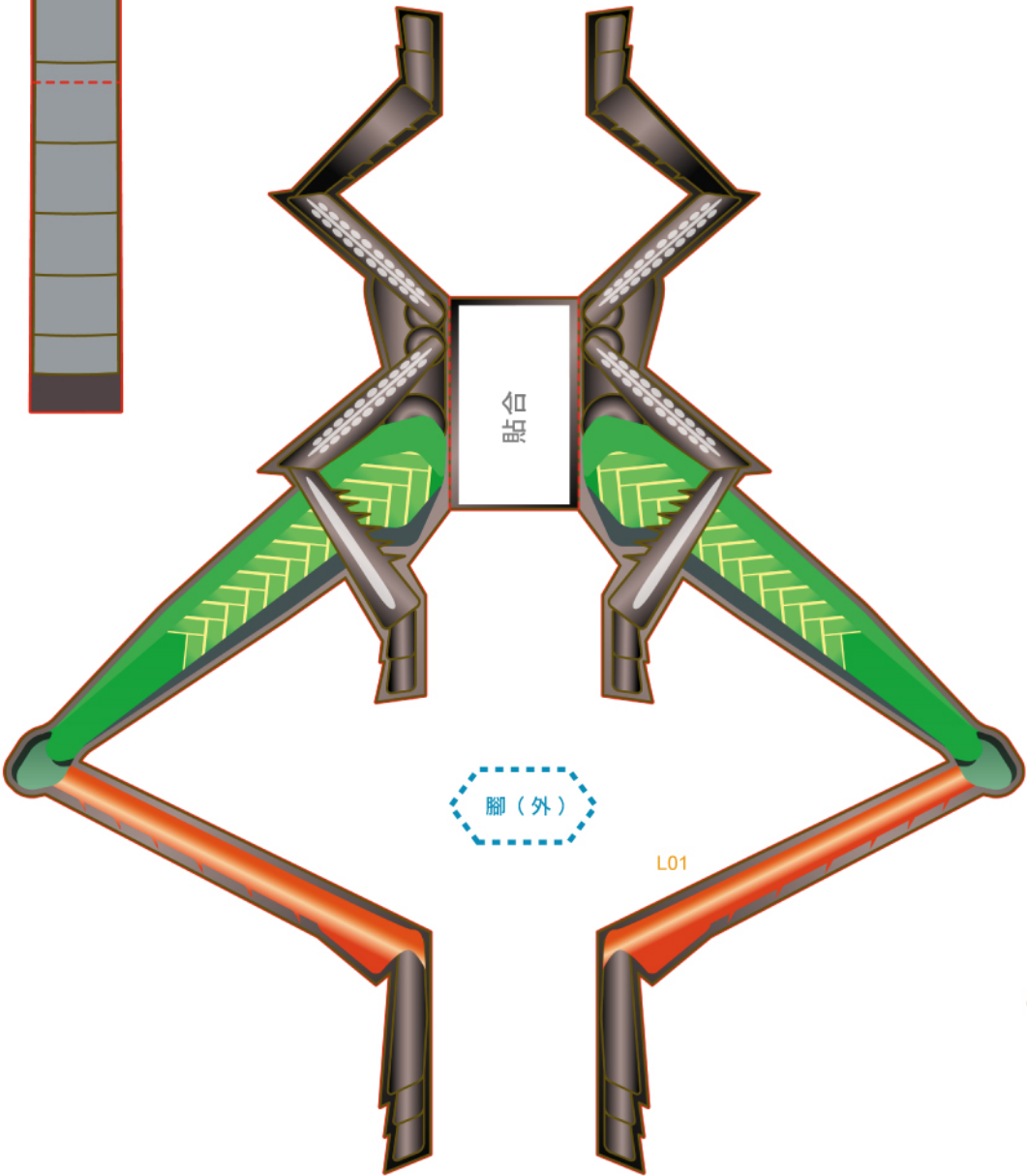

腳 (外)

L01

L03

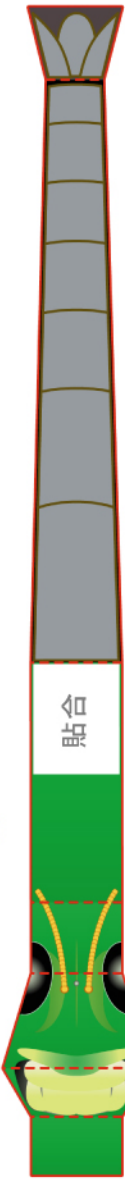

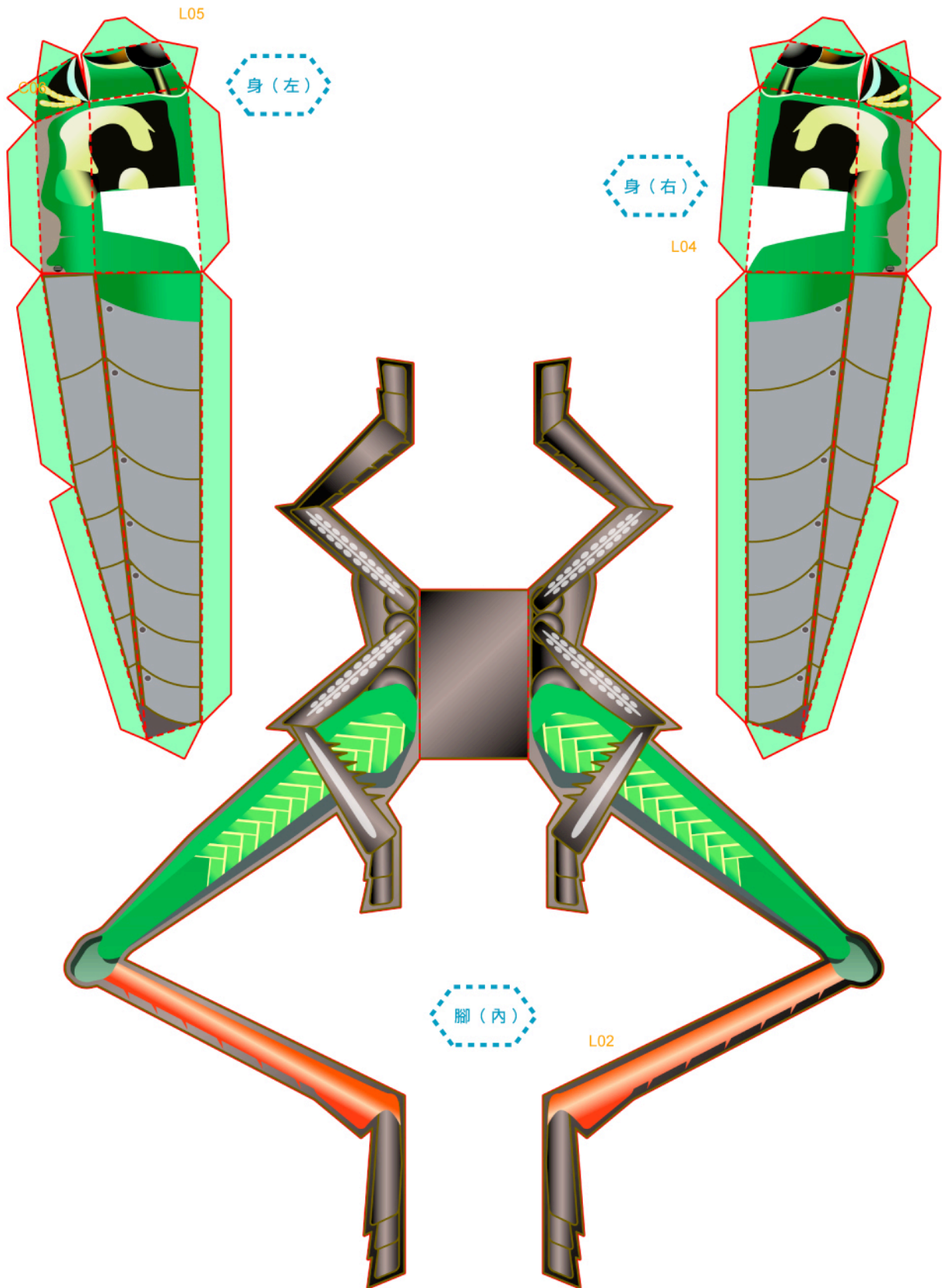

組合說明

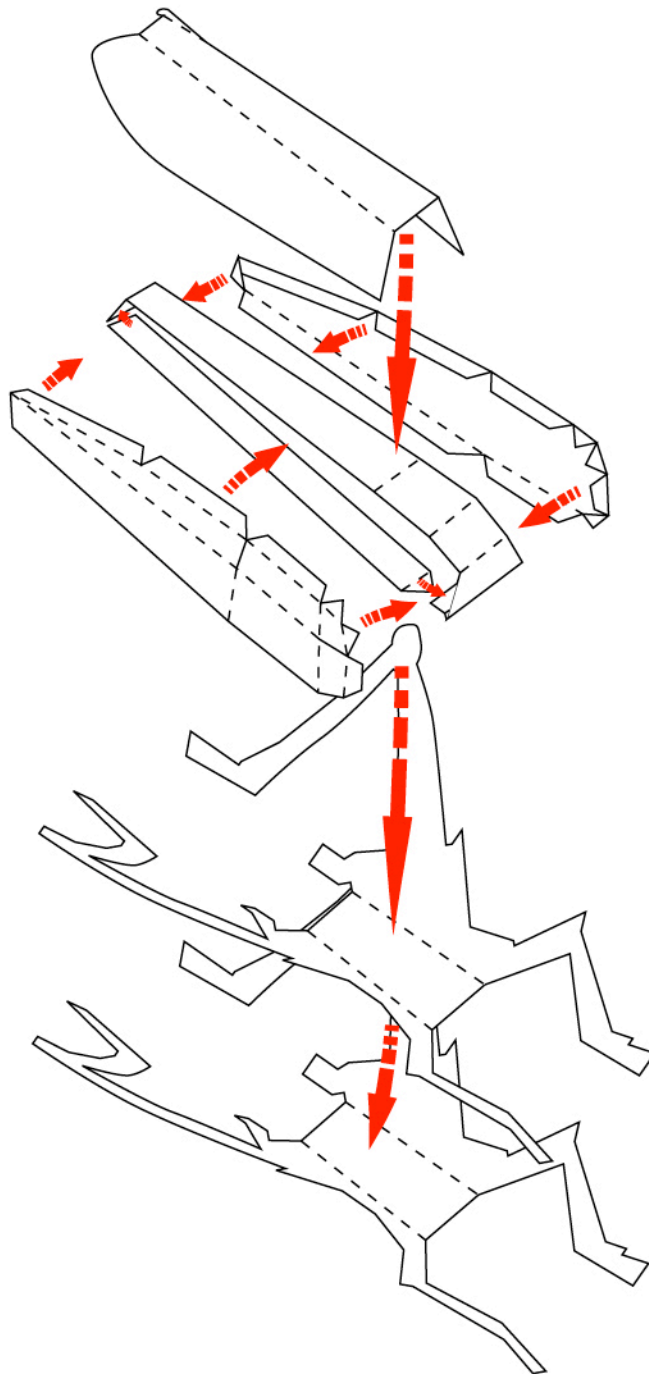
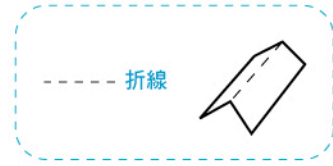

基本步驟

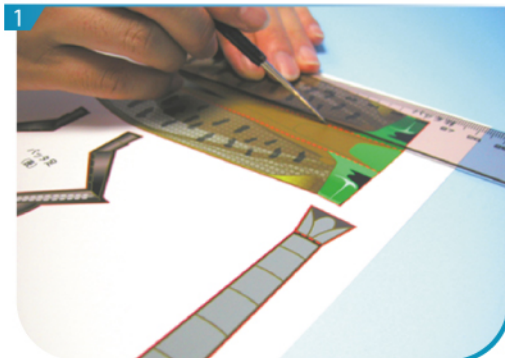

1 用沒有墨水的原子筆或鐵筆劃一下摺線。

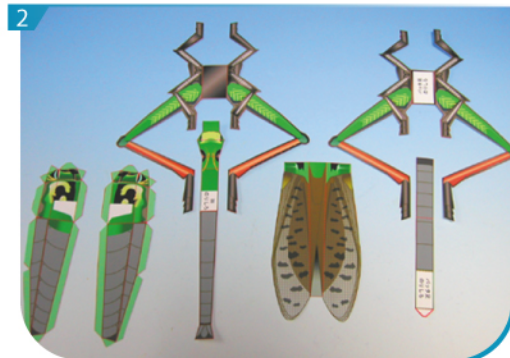

2 沿線剪出所有組件。為免混淆，可先在組件背面劃上記號。

製作步驟

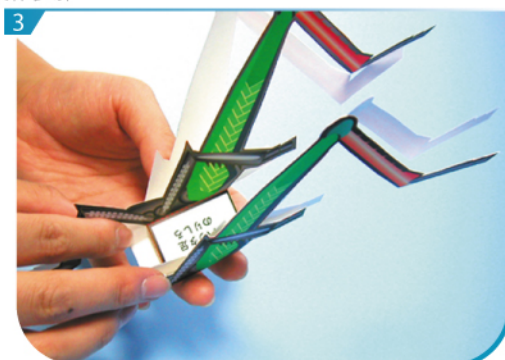

3 將L01及L02各自摺疊貼好，做成一對腳。

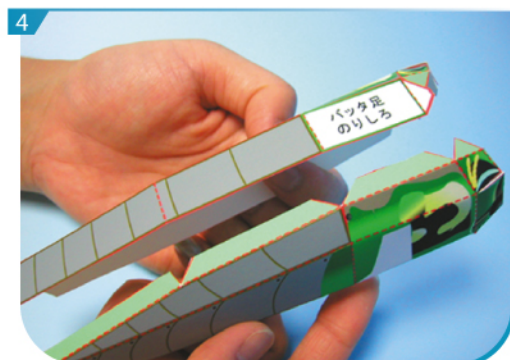

4 將L03、L04、L05及L06各自摺疊貼好，做成蚱蜢身體。



5 將腳及身體部份按預定位置黏合。

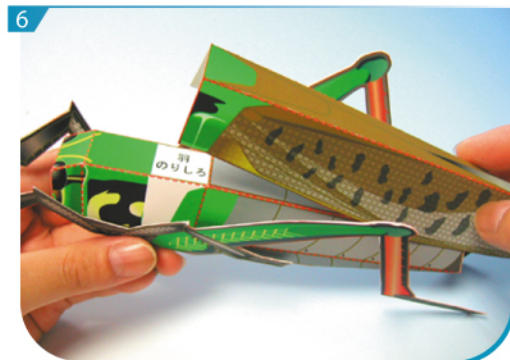

6 最後於預定位置將翅膀P07貼上，蚱蜢製作完成。