

ROBOT  
SPECIFICATIONS  
2023 CATALOG



# Why Epson® Robots?

As precision automation specialists, the Epson Robots team has been building automation products for nearly four decades. An industry leader in small-parts-assembly applications, we've introduced many firsts. As a result, our innovative products are hard at work in thousands of manufacturing facilities throughout the world.

## 1 Leading Epson technology

- Epson is the #1 SCARA robot manufacturer in the world
- We introduced the world's first folding-arm 6-Axis robot
- Specialized integrated motion sensors help reduce vibration and increase performance

## 2 What you need, when you need it

- The Epson lineup features 6-Axis and SCARA robots with payloads up to 20 kg and a reach ranging from 175 mm to 1,480 mm
- We offer a wide range of fully integrated options including vision guidance, conveyor tracking, flexible parts feeding, force guidance and more

## 3 Intuitive programming software

- Epson RC+® software is extremely user-friendly, making automation setup fast and easy
- It includes time-saving features such as wizards, templates, smart tools and more

## 4 Reliability you can count on

- Dedicated to helping you find the best solution for your automation needs
- Epson robots are long-lasting and require little maintenance
- Over 150,000 robots sold worldwide

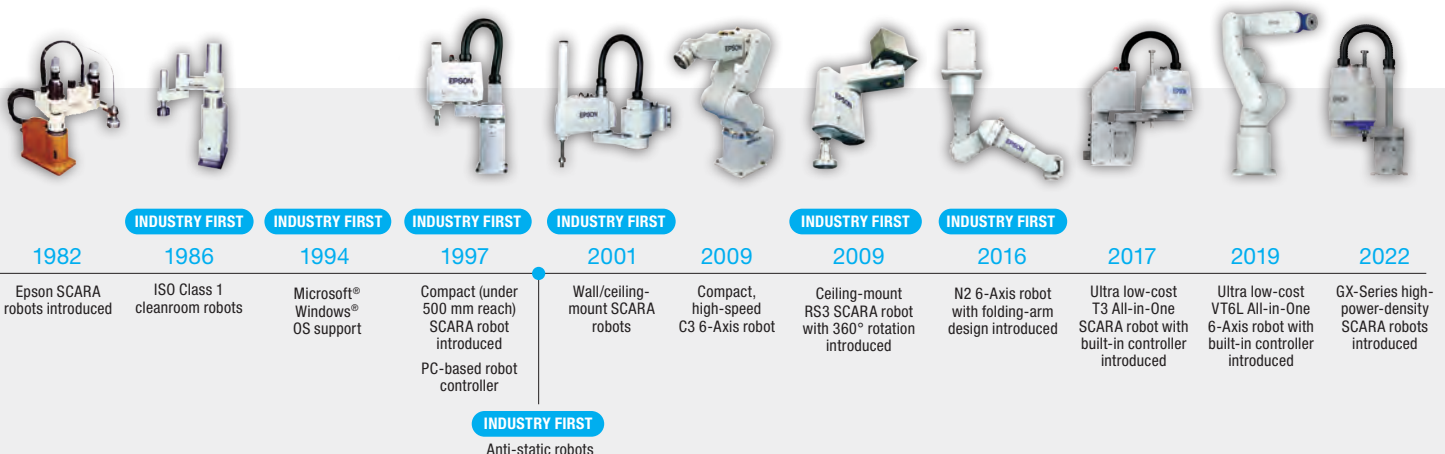

# Table of Contents

---

Robot Lineup 4

Industry Solutions 6

Applications 7

## SCARA

Overview 8

TB-Series 10

LSB-Series 14

RS-Series 20

GX-Series 24

G-Series 28

## 6-AXIS

Overview 36

VT-Series 38

N-Series 42

C-Series 46

## CONTROLLERS

Overview 50

All-in-One 52

RC90B 53

RC700A 54

RC700D 55

## EPSON RC+/EPSON RC+ EXPRESS

Overview 58

Epson RC+ Express 60

Epson RC+ 64

## INTEGRATED SOLUTIONS

Overview 68

Vision Guide 70

IntelliFlex™ 74

Force Guide 78

## OPTIONS

Overview 82

GUI Builder 84

RC+ 7.0 API, AOI and Conveyor Tracking 86

Fieldbus I/O and Teach Pendant 87

Miscellaneous Options 88

Training 91

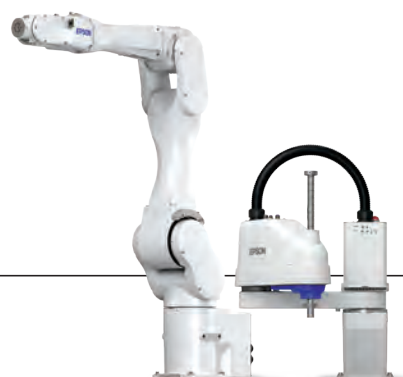

# SCARA



## Meet Epson's Lineup of Award-Winning SCARA and 6-Axis Robots

### TB-Series

Automate your factory without wasting time or money on complex slide-based solutions. These innovative All-in-One robots are available at an ultra low cost and offer fast, easy integration, taking less time to install than most automation solutions. With reach distances of 400 mm and 600 mm, they can handle payloads of 3 kg and 6 kg.

### LSB-Series

The perfect solution for factories looking for maximum value without sacrificing performance, the LSB-Series offers fast, compact performers at a low cost. With reach distances ranging from 400 mm to 1,000 mm, and payloads from 3 kg to 20 kg, they feature cycle times starting at 0.38 sec.

# 6-AXIS



## RS-Series

These zero-footprint robots are some of the most unique and flexible SCARA robots available on the market today. With reach distances of 350 mm and 550 mm, and payloads of 3 kg and 4 kg, they offer cycle times starting at 0.34 sec.

## VT-Series

Offering next-level technology at an incredible price, VT-Series All-in-One 6-Axis robots ensure easy setup with a built-in controller. With a reach of 900 mm and payloads up to 6 kg, these robots are ideal for simple applications such as machine load/unload, packaging, assembly and more.

## C4-Series

C4-Series robots offer excellent performance for the most demanding and complex tasks. Compact yet powerful, they deliver high repeatability and fast cycle times with reach distances ranging from 600 mm to 900 mm and payloads up to 4 kg.

## G-/GX-Series

With more than 300 models available, high-performance G- and GX-Series robots are ideal for applications where fast cycle times and high precision are required. The Epson lineup offers reach distances ranging from 175 mm to 1,000 mm and payloads from 1 kg to 20 kg, plus cycle times starting at 0.28 sec.

## N-Series

Setting a new standard for 6-Axis robots, the N-Series includes a revolutionary folding-arm design for maximum motion efficiency. N-Series robots offer reach distances of 450 mm to 1,000 mm and payloads of 2.5 kg and 6 kg.

## C8-/C12-Series

C8- and C12-Series robots are ideal for demanding applications requiring 6-Axis dexterity. With both long reach and heavy payloads, they provide remarkable flexibility. In fact, these compact robots offer reach distances ranging from 700 mm to 1,400 mm and payloads up to 12 kg.

# Industry Solutions

Epson Robots is a leading supplier to a wide variety of manufacturing industries including automotive, medical, electronics, consumer products, industrial and many more. Our customers range from large Fortune 100 companies to small manufacturing facilities.

- **Automotive:** Brakes, clutch components, ignition systems, instrument panels, headlights, mirrors, locks, sensors and more
- **Life sciences:** Contact lenses, glasses, dental instruments, dental implants, hearing aids, pacemakers, blood test systems and much more
- **Electronics:** Chip handling and placement, encoder assembly, board and laser diode testing, wire bonding and more
- **Consumer products:** Smartphones, tablets, speakers, jewelry, watches, cosmetics, printers and more



# Global High-Quality Support, When and Where It's Needed



At Epson, our reputation is built on the high quality of our products and services, and maintaining that quality is a worldwide priority. Our support network for robotic products includes nine regional centers, and we stand ready to meet the needs of customers in virtually every major market.

## Applications

Epson robots are extremely versatile and provide a wide range of automation possibilities:

- Assembly
- Pick and place
- Material handling
- Packaging
- Kitting/Tray loading
- Machine tending
- Screw driving
- Dispensing
- Palletizing
- Lab automation
- Inspection and testing
- Finishing
- Grinding

# Why Epson SCARA Robots?



**Epson's lineup of over 300 models** gives users the power to choose the right robot for their application. It's just part of what makes us the #1 SCARA robot manufacturer in the world.

## Hundreds of models available

- Sizes ranging from 175 mm to 1,000 mm in reach
- Payloads up to 20 kg
- Tabletop, wall- and ceiling-mount options

## Fast speeds

- Extraordinary cycle times to maximize parts per hour

## Extreme precision

- Repeatability down to 5 microns



# SCARA



## TB-Series All-in-One

**TB-Series All-in-One** SCARA robots are the perfect alternative to complex slide-based solutions. These space-saving robots install in minutes. And, they include the same intuitive software and powerful features found in Epson's high-end robots.



## LSB-Series

**LSB-Series** SCARA robots offer the high performance and great reliability that users have come to expect from Epson, but at a lower cost. LSB-Series SCARAs were created for factories looking for maximum value without giving up performance.



## RS-Series

**RS-Series** robots are some of the most unique and flexible SCARA robots available on the market today. With the ability to cross back under and reach behind themselves, RS-Series robots are able to utilize the entire workspace underneath the arm. As a result, there is no lost space in the center of the work envelope.



## G/GX-Series

**G- and GX-Series** SCARA robots feature a high-rigidity arm design that delivers high speed, high precision and low vibration. G- and GX-Series SCARA robots offer a wide variety of sizes from 175 mm to 1,000 mm in reach, with up to 20 kg payloads.



Epson is the #1 SCARA robot manufacturer in the world.



# TB-Series All-in-One

## Value without compromise

An innovative alternative to complex, slide-based systems, T3-B and T6-B All-in-One SCARA robots feature a built-in controller, power for end-of-arm tooling and 110 V or 220 V power.

# TB-SERIES

## SCARA ROBOTS

**ALL  
IN  
ONE**  
BUILT-IN CONTROLLER



**T3-B**

All-in-One design  
is the ultimate  
slide alternative



**T6-B**

Higher payload and  
longer reach at an  
incredible value



### TB-SERIES ALL-IN-ONE SPECIFICATIONS

		T3-B	T6-B
Arm length	Arm #1 + #2	400 mm	600 mm
Repeatability	Joints #1, #2	±0.020 mm	±0.040 mm
Payload	Rated	1 kg	2 kg
	Maximum	3 kg	6 kg
Standard cycle time <sup>1</sup>		0.52 sec	0.46 sec
Installation environment		Standard	
Available controllers		Built-in	

<sup>1</sup> Cycle time based on round-trip arch motion (300 mm horizontal, 25 mm vertical).

# TB-SERIES ALL-IN-ONE SCARA ROBOTS

## T3-B



Scan Here for  
CAD Drawings

### The ultimate slide alternative

- Arm length of 400 mm
- Easy to install
- Built-in controller
- Comes standard with 110 V and 220 V power
- No battery required for encoder



### SPECIFICATIONS

		T3-B-401
Mounting type		Tabletop
Arm length	Arm #1 + #2	400 mm
Weight (cables not included)		16 kg
Repeatability	Joints #1, #2	±0.020 mm
	Joint #3	±0.020 mm
	Joint #4	±0.020 deg
Max. motion range	Joint #1	±132 deg
	Joint #2	±141 deg
	Joint #3	150 mm
	Joint #4	±360 deg
Payload	Rated	1 kg
	Maximum	3 kg
Standard cycle time <sup>1</sup>		0.52 sec
Joint #4 allowable moment of inertia <sup>2</sup>	Rated	0.003 kg•m <sup>2</sup>
	Maximum	0.010 kg•m <sup>2</sup>
Joint #3 downward force		83 N
Electric lines		Hand I/O: IN6/OUT4 (D-Sub 15-Pin)/User I/O: IN18/OUT12
Pneumatic lines		Φ6 mm × 2, Φ4 mm × 1
Installation environment		Standard
Available controllers		Built-in
Safety standards		CE Mark: EMC Directive, Machinery Directive, RoHS Directive ANSI/RIA R15.06-2012 NFPA 79 (2007 Edition)

<sup>1</sup> Cycle time based on round-trip arch motion (300 mm horizontal, 25 mm vertical) with 1 kg payload (path coordinates optimized for maximum speed).  
<sup>2</sup> When payload center of gravity is aligned with Joint #4; if not aligned with Joint #4, set parameters using the INERTIA command.

# SCARA

## T6-B



Scan Here for  
CAD Drawings



The ultimate slide alternative—  
with longer reach and  
higher payload

- Arm length of 600 mm
- Easy to install
- Built-in controller
- Comes standard with 110 V and 220 V power
- No battery required for encoder

### ● SPECIFICATIONS

		T6-B-602
Mounting type		Tabletop
Arm length	Arm #1 + #2	600 mm
Weight (cables not included)		22 kg
Repeatability	Joints #1, #2	±0.040 mm
	Joint #3	±0.020 mm
	Joint #4	±0.020 deg
Max. motion range	Joint #1	±132 deg
	Joint #2	±150 deg
	Joint #3	200 mm
	Joint #4	±360 deg
Payload	Rated	2 kg
	Maximum	6 kg
Standard cycle time <sup>1</sup>		0.46 sec
Joint #4 allowable moment of inertia <sup>2</sup>	Rated	0.010 kg•m <sup>2</sup>
	Maximum	0.080 kg•m <sup>2</sup>
Joint #3 downward force		83 N
Electric lines		Hand I/O: IN6/OUT4 (D-Sub 15-Pin)/User I/O: IN18/OUT12
Pneumatic lines		Φ6 mm × 2, Φ4 mm × 1
Installation environment		Standard
Available controllers		Built-in
Safety standards		CE Mark: EMC Directive, Machinery Directive, RoHS Directive ANSI/RIA R15.06-2012 NFPA 79 (2007 Edition)

<sup>1</sup> Cycle time based on round-trip arch motion (300 mm horizontal, 25 mm vertical) with 2 kg payload (path coordinates optimized for maximum speed).  
<sup>2</sup> When payload center of gravity is aligned with Joint #4; if not aligned with Joint #4, set parameters using the INERTIA command.



# LSB-Series

**These fast, compact, low-cost solutions** are ideal for factories looking for maximum value without sacrificing performance. With payloads ranging from 3 kg to 20 kg and cycle times starting at 0.38 seconds, LSB-Series SCARA robots offer a variety of opportunities for manufacturers searching for a reduced-cost, high-performance automation solution with great reliability.

# LSB-SERIES

## SCARA ROBOTS



LS3-B

Fast, compact and low cost



LS6-B

Great performance at an affordable price



LS10-B

Powerful performance and a large payload at an affordable value



LS20-B

Remarkable value with long reach, high performance and heavy payload

### LSB-SERIES SPECIFICATIONS

		LS3-B	LS6-B	LS10-B	LS20-B
Arm length	Arm #1 + #2	400 mm	500/600/700 mm	600/700/800 mm	800/1,000 mm
Repeatability	Joints #1, #2	±0.010 mm	±0.020 mm	±0.020/±0.020/ ±0.025 mm	±0.025 mm
Payload	Rated	1 kg	2 kg	5 kg	10 kg
	Maximum	3 kg	6 kg	10 kg	20 kg
Standard cycle time <sup>1</sup>		0.42 sec	0.38/0.39/0.42 sec	0.39/0.41/0.44 sec	0.39/0.43 sec
Installation environments		Standard/Cleanroom ISO Class 4			
Available controllers		RC90B			

<sup>1</sup> Cycle time based on round-trip arch motion (300 mm horizontal, 25 mm vertical).

# LSB-SERIES SCARA ROBOTS

## LS3-B



Scan Here for  
CAD Drawings

### Fast, compact and low cost

- Arm length of 400 mm
- Small footprint
- Built-in camera cable
- Cleanroom ISO Class 4 models available



### SPECIFICATIONS

		LS3-B401
Mounting type		Tabletop
Arm length	Arm #1 + #2	400 mm
Weight (cables not included)		14 kg
Repeatability	Joints #1, #2	±0.010 mm
	Joint #3	±0.010 mm
	Joint #4	±0.010 deg
Max. motion range	Joint #1	±132 deg
	Joint #2	±141 deg
	Joint #3 Std	150 mm
	Joint #3 Clean	120 mm
	Joint #4	±360 deg
Payload	Rated	1 kg
	Maximum	3 kg
Standard cycle time <sup>1</sup>		0.42 sec
Joint #4 allowable moment of inertia <sup>2</sup>	Rated	0.005 kg•m <sup>2</sup>
	Maximum	0.050 kg•m <sup>2</sup>
Joint #3 downward force		100 N
Electric lines		15 (15-Pin: D-Sub), 8 (8-Pin: RJ45) Cat5e
Pneumatic lines		Φ4 mm × 1, Φ6 mm × 2
Installation environments		Standard/Cleanroom ISO Class 4
Available controllers		RC90B
Safety standards		CE Mark: EMC Directive, Machinery Directive, RoHS Directive ANSI/RIA R15.06-2012 NFPA 79 (2007 Edition)

<sup>1</sup> Cycle time based on round-trip arch motion (300 mm horizontal, 25 mm vertical) with 2 kg payload (path coordinates optimized for maximum speed).  
<sup>2</sup> When payload center of gravity is aligned with Joint #4; if not aligned with Joint #4, set parameters using the INERTIA command.



# SCARA

## LS6-B



Scan Here for  
CAD Drawings



### Low cost and high performance

- Arm lengths of 500, 600 and 700 mm
- Built-in camera cable
- Fast cycle throughput
- Cleanroom ISO Class 4 models available

### SPECIFICATIONS

		LS6-B502	LS6-B602	LS6-B702
Mounting type		Tabletop		
Arm length	Arm #1 + #2	500 mm	600 mm	700 mm
Weight (cables not included)		17 kg	17 kg	18 kg
Repeatability	Joints #1, #2	±0.020 mm		
	Joint #3	±0.010 mm		
	Joint #4	±0.010 deg		
Max. motion range	Joint #1	±132 deg		
	Joint #2	±150 deg		
	Joint #3 Std	200 mm		
	Joint #3 Clean	170 mm		
	Joint #4	±360 deg		
Payload	Rated	2 kg		
	Maximum	6 kg		
Standard cycle time <sup>1</sup>		0.38 sec	0.39 sec	0.42 sec
Joint #4 allowable moment of inertia <sup>2</sup>	Rated	0.010 kg•m <sup>2</sup>		
	Maximum	0.120 kg•m <sup>2</sup>		
Joint #3 downward force		100 N		
Electric lines		15 (15-Pin: D-Sub), 8 (8-Pin: RJ45) Cat5e		
Pneumatic lines		Φ4 mm × 1, Φ6 mm × 2		
Installation environments		Standard/Cleanroom ISO Class 4		
Available controllers		RC90B		
Safety standards		CE Mark: EMC Directive, Machinery Directive, RoHS Directive ANSI/RIA R15.06-2012 NFPA 79 (2007 Edition)		

<sup>1</sup> Cycle time based on round-trip arch motion (300 mm horizontal, 25 mm vertical) with 2 kg payload (path coordinates optimized for maximum speed).

<sup>2</sup> When payload center of gravity is aligned with Joint #4; if not aligned with Joint #4, set parameters using the INERTIA command.

# LSB-SERIES SCARA ROBOTS

## LS10-B



Scan Here for  
CAD Drawings



### Powerful, fast and affordable

- Arm lengths of 600, 700 and 800 mm
- Built-in camera cable
- No battery required for encoder
- Cleanroom ISO Class 4 models available

### ● SPECIFICATIONS

		LS10-B60X	LS10-B70X	LS10-B80X
Mounting type		Tabletop		
Arm length	Arm #1 + #2	600 mm	700 mm	800 mm
Weight (cables not included)		22 kg	22 kg	23 kg
Repeatability	Joints #1, #2	±0.020 mm	±0.020 mm	±0.025 mm
	Joint #3	±0.010 mm		
	Joint #4	±0.010 deg		
Max. motion range	Joint #1	±132 deg		
	Joint #2	±150 deg		
	Joint #3 Std	200 mm or 300 mm		
	Joint #3 Clean	170 mm or 270 mm		
	Joint #4	±360 deg		
Payload	Rated	5 kg		
	Maximum	10 kg		
Standard cycle time <sup>1</sup>		0.39 sec	0.41 sec	0.44 sec
Joint #4 allowable moment of inertia <sup>2</sup>	Rated	0.020 kg•m <sup>2</sup>		
	Maximum	0.300 kg•m <sup>2</sup>		
Joint #3 downward force		200 N		
Electric lines		15 (15-Pin: D-Sub), 8 (8-Pin: RJ45) Cat5e		
Pneumatic lines		Φ4 mm × 1, Φ6 mm × 2		
Installation environments		Standard/Cleanroom ISO Class 4		
Available controllers		RC90B		
Safety standards		CE Mark: EMC Directive, Machinery Directive, RoHS Directive ANSI/RIA R15.06-2012 NFPA 79 (2007 Edition)		

<sup>1</sup> Cycle time based on round-trip arch motion (300 mm horizontal, 25 mm vertical) with 2 kg payload (path coordinates optimized for maximum speed).

<sup>2</sup> If the center of gravity is at the center of each arm. If the center of gravity is not at the center of each arm, set the eccentric quantity using the INERTIA command.

# LS20-B



Scan Here for  
CAD Drawings



Long reach,  
heavy payload—  
all at a great value

- Arm lengths of 800 and 1,000 mm
- Fast cycle times
- Built-in camera cable
- Cleanroom ISO Class 4 models available

## SPECIFICATIONS

		LS20-B804	LS20-BA04
Mounting type		Tabletop	
Arm length	Arm #1 + #2	800 mm	1,000 mm
Weight (cables not included)		48 kg	51 kg
Repeatability	Joints #1, #2	±0.025 mm	
	Joint #3	±0.010 mm	
	Joint #4	±0.010 deg	
Max. motion range	Joint #1	±132 deg	
	Joint #2	±152 deg	
	Joint #3 Std	420 mm	
	Joint #3 Clean	390 mm	
	Joint #4	±360 deg	
Payload	Rated	10 kg	
	Maximum	20 kg	
Standard cycle time <sup>1</sup>		0.39 sec	0.43 sec
Joint #4 allowable moment of inertia <sup>2</sup>	Rated	0.050 kg•m <sup>2</sup>	
	Maximum	1.000 kg•m <sup>2</sup>	
Joint #3 downward force		250 N	
Electric lines		15 (15-Pin: D-Sub), 9 (9-Pin: D-Sub), 8 (8-Pin: RJ45) Cat5e	
Pneumatic lines		Φ4 mm × 1, Φ6 mm × 2	
Installation environments		Standard/Cleanroom ISO Class 4	
Available controllers		RC90B	
Safety standards		CE Mark: EMC Directive, Machinery Directive, RoHS Directive ANSI/RIA R15.06-2012 NFPA 79 (2007 Edition)	

<sup>1</sup> Cycle time based on round-trip arch motion (300 mm horizontal, 25 mm vertical) with 2 kg payload (path coordinates optimized for maximum speed).  
<sup>2</sup> When payload center of gravity is aligned with Joint #4; if not aligned with Joint #4, set parameters using the INERTIA command.



# RS-Series

**RS-Series SCARA robots are unique and highly flexible.** Offering payloads of 3 kg or 4 kg and cycle times starting at 0.34 seconds, they have the ability to cross under as well as reach behind themselves. RS-Series robots are able to utilize the entire workspace underneath the arm. As a result, there is no lost space in the center of the work envelope.

# RS-SERIES

## SCARA ROBOTS



RS3

Compact SCARA robot with unique workspace design



RS4

High-performance, innovative workspace design with longer reach capabilities



### RS-SERIES SPECIFICATIONS

		RS3	RS4
Arm length	Arm #1 + #2	350 mm	550 mm
Repeatability	Joints #1, #2	±0.010 mm	±0.015 mm
Payload	Rated	1 kg	1 kg
	Maximum	3 kg	4 kg
Standard cycle time <sup>1</sup>		0.34 sec	0.39 sec
Installation environments		Standard/Cleanroom ISO Class 3 with ESD	
Available controllers		RC700A	

<sup>1</sup> Cycle time based on round-trip arch motion (300 mm horizontal, 25 mm vertical).

# RS-SERIES SCARA ROBOTS

## RS3



Scan Here for  
CAD Drawings

### Compact with unique workspace design

- Arm length of 350 mm
- Payloads up to 3 kg
- Maximum motion efficiency
- Cleanroom ISO Class 3 models available



## SPECIFICATIONS

		RS3-351
Mounting type		Ceiling
Arm length	Arm #1 + #2	350 mm
Weight (cables not included)		17 kg
Repeatability	Joints #1, #2	±0.010 mm
	Joint #3	±0.010 mm
	Joint #4	±0.010 deg
Max. motion range	Joint #1	±225 deg
	Joint #2	±225 deg
	Joint #3 Std	130 mm
	Joint #3 Clean	100 mm
	Joint #4	±720 deg
Payload	Rated	1 kg
	Maximum	3 kg
Standard cycle time <sup>1</sup>		0.34 sec
Joint #4 allowable moment of inertia <sup>2</sup>	Rated	0.005 kg•m <sup>2</sup>
	Maximum	0.050 kg•m <sup>2</sup>
Joint #3 downward force		150 N
Electric lines		15-Pin (D-Sub)
Pneumatic lines		Φ4 mm × 1, Φ6 mm × 2
Installation environments		Standard/Cleanroom ISO Class 3 with ESD
Available controllers		RC700A
Safety standards		CE Mark: EMC Directive, Machinery Directive, RoHS Directive UL1740 ANSI/RIA R15.06 NFFPA 79

<sup>1</sup> Cycle time based on round-trip arch motion (300 mm horizontal, 25 mm vertical) with 1 kg payload (path coordinates optimized for maximum speed).

<sup>2</sup> When payload center of gravity is aligned with Joint #4; if not aligned with Joint #4, set parameters using the INERTIA command.

# RS4



Scan Here for  
CAD Drawings

## High-performance, innovative workspace design

- Arm length of 550 mm
- Payloads up to 4 kg
- Superior cycle times
- Cleanroom ISO Class 3 models available



### SPECIFICATIONS

		RS4-551
Mounting type		Ceiling
Arm length	Arm #1 + #2	550 mm
Weight (cables not included)		19 kg
Repeatability	Joints #1, #2	±0.015 mm
	Joint #3	±0.010 mm
	Joint #4	±0.010 deg
Max. motion range	Joint #1	±225 deg
	Joint #2	±225 deg
	Joint #3 Std	130 mm
	Joint #3 Clean	100 mm
	Joint #4	±720 deg
Payload	Rated	1 kg
	Maximum	4 kg
Standard cycle time <sup>1</sup>		0.39 sec
Joint #4 allowable moment of inertia <sup>2</sup>	Rated	0.005 kg•m <sup>2</sup>
	Maximum	0.050 kg•m <sup>2</sup>
Joint #3 downward force		150 N
Electric lines		15-Pin (D-Sub)
Pneumatic lines		Φ4 mm × 1, Φ6 mm × 2
Installation environments		Standard/Cleanroom ISO Class 3 with ESD
Available controllers		RC700A
Safety standards		CE Mark: EMC Directive, Machinery Directive, RoHS Directive UL1740 ANSI/RIA R15.06 NFPA 79

<sup>1</sup> Cycle time based on round-trip arch motion (300 mm horizontal, 25 mm vertical) with 1 kg payload (path coordinates optimized for maximum speed).

<sup>2</sup> When payload center of gravity is aligned with Joint #4; if not aligned with Joint #4, set parameters using the INERTIA command.



EPSON

# GX-Series

Introducing the GX-Series, part of Epson's new high-power-density SCARA robot lineup. The GX-Series builds upon 40 years of expertise to deliver next-level performance and flexibility in a compact footprint. A breakthrough in productivity, the GX-Series uses advanced Epson GYROPLUS Technology to provide fast production speeds and smooth motion control, all with higher payloads.



# GX-SERIES

## SCARA ROBOTS



GX4

Ultra high performance and flexibility



GX8

Heavier payloads and longer reach with reduced vibration



GX8 SCARA

### GX-SERIES SPECIFICATIONS

		GX4	GX8
Arm length	Arm #1 + #2	250/300/350 mm	450/550/650 mm
Repeatability	Joints #1, #2	±0.008/ ±0.010 mm	±0.015 mm
Payload	Rated	2 kg	4 kg
	Maximum	4 kg	8 kg
Standard cycle time		0.33/0.34/0.35 sec	0.28/0.30/0.33 sec
Installation environments		Standard/ESD/Cleanroom ISO Class 3 with ESD	Standard/ESD/Cleanroom ISO Class 3 with ESD/Protected IP65
Available controllers		RC700D	

# GX-SERIES SCARA ROBOTS

## GX4



Scan Here for  
CAD Drawings

## Ultra high performance and flexibility

- Handles high payloads from a small footprint
- Arm lengths of 250, 300 and 350 mm
- Epson's GYROPLUS Technology reduces vibration
- Curved arm option (350 mm) maximizes work envelope
- Cleanroom ISO Class 3 models available



### SPECIFICATIONS

		GX4-A251x	GX4-A301x		GX4-A351x		
<b>Mounting type</b>		Tabletop	Tabletop	Multiple	Tabletop	Multiple	
<b>Arm length</b>	<b>Arm #1 + #2</b>	250 mm	300 mm		350 mm		
<b>Weight (cables not included)</b>		15 kg	15 kg	17 kg	16 kg	17 kg	
<b>Repeatability</b>	<b>Joints #1, #2</b>	±0.008 mm	±0.010 mm				
	<b>Joint #3</b>	±0.010 mm					
	<b>Joint #4</b>	±0.005 deg					
	<b>Joint #1</b>	±140 deg	±140 deg	±115 deg	±140 deg	±120 deg	
<b>Max. motion range</b>	<b>Straight</b>	<b>Joint #2 Std</b>	±141 deg	±142 deg	±135 deg	±142 deg	
		<b>Joint #2 Clean</b>	±137 deg	±137 deg	±135 deg	±142 deg	
		<b>Joint #1 Right Hand</b>					-110 ~ 165 deg
	<b>Curved</b>	<b>Joint #1 Left Hand</b>					-165 ~ 110 deg
		<b>Joint #2 Right Hand Std &amp; ESD</b>					-120 ~ 165 deg
		<b>Joint #2 Right Hand Clean</b>					-120 ~ 160 deg
		<b>Joint #2 Left Hand Std &amp; ESD</b>					-165 ~ 120 deg
		<b>Joint #2 Left Hand Clean</b>					-160 ~ 120 deg
	<b>All Models</b>	<b>Joint #3 Std &amp; ESD</b>					150 mm
		<b>Joint #3 Clean</b>					120 mm
<b>Joint #4</b>						±360 deg	
<b>Payload</b>	<b>Rated</b>	2 kg					
	<b>Maximum</b>	4 kg					
<b>Standard cycle time<sup>1</sup></b>		0.33 sec	0.34 sec		0.35 sec		
<b>Joint #4 allowable moment of inertia<sup>2</sup></b>	<b>Rated</b>	0.005 kg•m <sup>2</sup>					
	<b>Maximum</b>	0.05 kg•m <sup>2</sup>					
<b>Joint #3 downward force</b>		150 N					
<b>Electric lines</b>		15-Pin (D-Sub), 8-Pin (RJ45 Cat5e)					
<b>Pneumatic lines</b>		Φ6 mm x 2, ø4 mm x 1					
<b>Installation environments</b>		Standard/ESD/Cleanroom ISO Class 3 with ESD					
<b>Available controllers</b>		RC700D					
<b>Safety standards</b>		CE Mark: UL1740					

<sup>1</sup> Cycle time based on round-trip arch motion (300 mm horizontal, 25 mm vertical) with 2 kg payload of tabletop model boost mode (path coordinates optimized for maximum speed).  
<sup>2</sup> When payload center of gravity is aligned with Joint #4; if not aligned with Joint #4, set parameters using the INERTIA command.

# GX8



Scan Here for  
CAD Drawings



## Heavier payloads and longer reach with reduced vibration

- High power density
- Arm lengths of 450, 550 and 650 mm
- Longer Z axis available on all models
- Higher acceleration and faster settling times
- Cleanroom ISO Class 3 models available

### SPECIFICATIONS

		GX8-A45x			GX8-A55x			GX8-A65x		
Mounting type		Tabletop	Ceiling	Wall	Tabletop	Ceiling	Wall	Tabletop	Ceiling	Wall
Arm length	Arm #1 + #2	450 mm			550 mm			650 mm		
Weight (cables not included)		33 kg		35 kg	34 kg		36 kg	35 kg		37 kg
Repeatability	Joints #1, #2	±0.015 mm								
	Joint #3	±0.010 mm								
	Joint #4	±0.005 deg								
	Max. motion range	Joint #1	±152 deg	±105 deg	±105 deg	±152 deg	±152 deg	±135 deg	±152 deg	±152 deg
	Joint #2 Std & ESD	Z: 0 mm ~ -270 mm ± 147.5 deg Z: -270 mm ~ -330 mm ± 145 deg	±125 deg		±147.5 deg			±147.5 deg		
	Joint #2 Clean/Protected	Z: 0 mm ~ -240 mm ± 147.5 deg Z: -240 mm ~ -300 mm ± 137.5 deg			Z: 0 ~ -240 mm ± 147.5 deg, Z: -240 ~ -300 mm ± 145 deg		±145 deg			
	Joint #3 Std & ESD	200 mm/330 mm								
	Joint #3 Clean/Protected	170 mm/300 mm								
	Joint #4	±360 deg								
Payload	Rated	4 kg								
	Maximum	8 kg								
Standard cycle time <sup>1</sup>		0.28 sec			0.30 sec			0.33 sec		
Joint #4 allowable moment of inertia <sup>2</sup>	Rated	0.01 kg•m <sup>2</sup>								
	Maximum	0.16 kg•m <sup>2</sup>								
Joint #3 downward force		150 N								
Electric lines		15-Pin (D-Sub), 9-Pin (D-Sub), 8-Pin (RJ45 Cat5e)								
Pneumatic lines		Φ4 mm x 2, Φ6 mm x 2								
Installation environments		Standard/ESD/Cleanroom ISO Class 3 with ESD/Protected IP65								
Available controllers		RC700D								
Safety standards		CE Mark: UL1740								

<sup>1</sup> Cycle time based on round-trip arch motion (300 mm horizontal, 25 mm vertical) with 2 kg payload of tabletop model boost mode (path coordinates optimized for maximum speed).  
<sup>2</sup> When payload center of gravity is aligned with Joint #4; if not aligned with Joint #4, set parameters using the INERTIA command.



# G-Series

**With a vast product lineup** including reach options from 175 mm to 1,000 mm, G-Series robots are rich in features and performance. With payloads ranging from 1 kg to 20 kg and cycle times down to 0.29 seconds, G-Series robots offer the speed and overall performance to accomplish even the most difficult tasks. Featuring a unique high-rigidity arm design, which reduces vibration, these robots deliver fast speeds and high precision with no overshoot or ringing.

# G-SERIES

## SCARA ROBOTS



**G1**

High-performance, high-precision mini SCARA robot



**G3**

Compact, fast and powerful with straight or unique curved arm



**G6**

Ultra fast speeds with extraordinary motion range



**G10**

Provides high speed at heavy payloads



**G20**

Long reach and high payloads with strong J4 inertia



Cleanroom/ESD G6 SCARA

### G-SERIES SPECIFICATIONS

		G1	G3	G6	G10	G20
Arm length	Arm #1 + #2	175/225 mm	250/300/350 mm	450/550/650 mm	650/850 mm	850/1,000 mm
Repeatability	Joints #1, #2	±0.005/ ±0.008 mm	±0.008/ ±0.010 mm	±0.015 mm	±0.025 mm	±0.025 mm
Payload	Rated	0.5 kg	1 kg	3 kg	5 kg	10 kg
	Maximum	1 kg	3 kg	6 kg	10 kg	20 kg
Standard cycle time <sup>1</sup>		0.29/0.30 sec	0.36/0.37/0.37 sec	0.33/0.36/0.38 sec	0.34/0.37 sec	0.37/0.42 sec
Installation environments		Standard/Cleanroom ISO Class 3 with ESD		Standard/Cleanroom ISO Class 3 with ESD/Protected IP54 and IP65		
Available controllers		RC700A				

<sup>1</sup> Cycle time based on round-trip arch motion (300 mm horizontal, 25 mm vertical; G1: 100 mm horizontal, 25 mm vertical).

# G-SERIES SCARA ROBOTS

# G1



Scan Here for  
CAD Drawings



## Powerful mini SCARA

- High-precision repeatabilities down to 0.005 mm
- Arm lengths of 175 and 225 mm
- Ultra compact, yet extremely powerful
- Cleanroom ISO Class 3 models available
- 3-Axis models available

### SPECIFICATIONS

		G1-171	G1-221	G1-171xZ	G1-221xZ
Number of axes		4-Axis		3-Axis	
Mounting type		Tabletop		Tabletop	
Arm length	Arm #1 + #2	175 mm	225 mm	175 mm	225 mm
Weight (cables not included)		8 kg		8 kg	
Repeatability	Joints #1, #2	±0.005 mm	±0.008 mm	±0.005 mm	±0.008 mm
	Joint #3	±0.010 mm		±0.010 mm	
	Joint #4	±0.010 deg		-	
Max. motion range	Joint #1	±125 deg		±125 deg	
	Joint #2 Std	±140 deg	±152 deg	±135 deg	±135 deg
	Joint #2 Clean	±140 deg	±149 deg	±123 deg	±132 deg
	Joint #3 Std	100 mm		100 mm	
	Joint #3 Clean	80 mm		80 mm	
	Joint #4	±360 deg		-	
Payload	Rated	0.5 kg		0.5 kg	
	Maximum	1 kg		1.5 kg	
Standard cycle time <sup>1</sup>		0.29 sec	0.30 sec	0.29 sec	0.30 sec
Joint #4 allowable moment of inertia <sup>2</sup>	Rated	0.0003 kg•m <sup>2</sup>		-	
	Maximum	0.0040 kg•m <sup>2</sup>		-	
Joint #3 downward force		50 N			
Electric lines		24 (9-Pin D-Sub, 15-Pin D-Sub)			
Pneumatic lines		Φ4 mm × 1, Φ6 mm × 2			
Installation environments		Standard/Cleanroom ISO Class 3 with ESD			
Available controllers		RC700A			
Safety standards		CE Mark: EMC Directive, Machinery Directive, RoHS Directive UL1740 ANSI/RIA R15.06 NFPA 79			

<sup>1</sup> Cycle time based on round-trip arch motion (100 mm horizontal, 25 mm vertical) with 0.5 kg payload (path coordinates optimized for maximum speed).

<sup>2</sup> When payload center of gravity is aligned with Joint #4; if not aligned with Joint #4, set parameters using the INERTIA command.

# G3



Scan Here for  
CAD Drawings

## Compact and ultra powerful

- Arm lengths of 250, 300 and 350 mm
- Handles payloads up to 3 kg
- Fast cycle times for increased productivity
- Available with straight or curved arm
- Cleanroom ISO Class 3 models available



### SPECIFICATIONS

		G3-251	G3-301		G3-351				
<b>Mounting type</b>		Tabletop	Tabletop	Multiple	Tabletop	Multiple			
<b>Arm length</b>		<b>Arm #1 + #2</b>							
		250 mm	300 mm		350 mm				
<b>Weight (cables not included)</b>		14 kg							
<b>Repeatability</b>		<b>Joints #1, #2</b>		±0.010 mm					
		±0.008 mm							
		<b>Joint #3</b>							
		±0.010 mm							
		<b>Joint #4</b>							
		±0.005 deg							
<b>Max. motion range</b>	<b>Straight</b>	<b>Joint #1</b>		±140 deg	±140 deg	±115 deg	±140 deg	±120 deg	
		<b>Joint #2 Std</b>		±141 deg	±142 deg	±135 deg	±142 deg		
		<b>Joint #2 Clean</b>		±137 deg	±141 deg	±135 deg	±142 deg		
	<b>Curved</b>	<b>Joint #1 Right Hand</b>		-	-125~150 deg	-	-110~165 deg	-105~130 deg	
		<b>Joint #1 Left Hand</b>		-	-150~125 deg	-	-165~110 deg	-130~105 deg	
		<b>Joint #2 Right Hand Std</b>		-	-135~150 deg	-	-120~165 deg	-120~160 deg	
		<b>Joint #2 Right Hand Clean</b>		-	-135~145 deg	-	-120~160 deg	-120~150 deg	
		<b>Joint #2 Left Hand Std</b>		-	-150~135 deg	-	-165~120 deg	-160~120 deg	
		<b>Joint #2 Left Hand Clean</b>		-	-145~135 deg	-	-160~120 deg	-150~120 deg	
	<b>All models</b>	<b>Joint #3 Std</b>		150 mm					
		<b>Joint #3 Clean</b>		120 mm					
		<b>Joint #4</b>		±360 deg					
	<b>Payload</b>		<b>Rated</b>		1 kg				
		<b>Maximum</b>		3 kg					
<b>Standard cycle time<sup>1</sup></b>		0.36 sec	0.37 sec						
<b>Joint #4 allowable moment of inertia<sup>2</sup></b>		<b>Rated</b>		0.005 kg•m <sup>2</sup>					
		<b>Maximum</b>		0.050 kg•m <sup>2</sup>					
<b>Joint #3 downward force</b>		150 N							
<b>Electric lines</b>		15-Pin (D-Sub)							
<b>Pneumatic lines</b>		∅4 mm × 1, ∅6 mm × 2							
<b>Installation environments</b>		Standard/Cleanroom ISO Class 3 with ESD							
<b>Available controllers</b>		RC700A							
<b>Safety standards</b>		CE Mark: EMC Directive, Machinery Directive, RoHS Directive ANSI/RIA R15.06 UL1740 NFPA 79							

<sup>1</sup> Cycle time based on round-trip arch motion (300 mm horizontal, 25 mm vertical) with 1 kg payload (path coordinates optimized for maximum speed).

<sup>2</sup> When payload center of gravity is aligned with Joint #4; if not aligned with Joint #4, set parameters using the INERTIA command.

# G-SERIES SCARA ROBOTS

# G6



Scan Here for  
CAD Drawings



## Compact, fast and powerful

- Arm lengths of 450, 550 and 650 mm
- High-rigidity arm = ultra high speed
- Tabletop, wall- and ceiling-mount models available
- Cleanroom ISO Class 3 and Protected IP65 models available

## SPECIFICATIONS

		G6-45x			G6-55x			G6-65x		
Mounting type		Tabletop	Ceiling	Wall	Tabletop	Ceiling	Wall	Tabletop	Ceiling	Wall
Arm length	Arm #1 + #2	450 mm			550 mm			650 mm		
Weight (cables not included)		27 kg		29 kg	27 kg	29 kg	28 kg	29.5 kg		
Repeatability	Joints #1, #2	±0.015 mm								
	Joint #3	±0.010 mm								
	Joint #4	±0.005 deg								
Max. motion range	Joint #1	±152 deg	±120 deg	±105 deg	±152 deg	±135 deg	±152 deg	±148 deg		
	Joint #2	Z: 0 mm ~ -270 mm ±147.5 deg Z: -270 mm ~ -330 mm ±145 deg	±130 deg		±147.5 deg					
	Joint #3 Std	180 mm/330 mm								
	Joint #3 Clean	150 mm/300 mm								
	Joint #4	±360 deg								
Payload	Rated	3 kg								
	Maximum	6 kg								
Standard cycle time <sup>1</sup>		0.33 sec			0.36 sec			0.38 sec		
Joint #4 allowable moment of inertia <sup>2</sup>	Rated	0.010 kg•m <sup>2</sup>								
	Maximum	0.120 kg•m <sup>2</sup>								
Joint #3 downward force		150 N								
Electric lines		24 (9-Pin D-Sub, 15-Pin D-Sub)								
Pneumatic lines		Φ4 mm × 2, Φ6 mm × 2								
Installation environments		Standard/Cleanroom ISO Class 3 with ESD/Protected IP54 and IP65								
Available controllers		RC700A								
Safety standards		CE Mark: EMC Directive, Machinery Directive, RoHS Directive UL1740 ANSI/RIA R15.06 NFPA 79								

<sup>1</sup> Cycle time based on round-trip arch motion (300 mm horizontal, 25 mm vertical) with 1 kg payload (path coordinates optimized for maximum speed).

<sup>2</sup> When payload center of gravity is aligned with Joint #4; if not aligned with Joint #4, set parameters using the INERTIA command.



# SCARA



SCARA Robots

6-Axis Robots

Controllers

Epson RC+ Software | Integrated Solutions

Options

# G-SERIES SCARA ROBOTS

## G10



Scan Here for  
CAD Drawings



## Long reach at high speeds

- Arm lengths of 650 and 850 mm
- Reduced residual vibration for faster accel./decel. rates
- Tabletop, wall- and ceiling-mount models available
- Cleanroom ISO Class 3 and Protected IP65 models available

### SPECIFICATIONS

		G10-65x			G10-85x		
Mounting type		Tabletop	Ceiling	Wall	Tabletop	Ceiling	Wall
Arm length	Arm #1 + #2	650 mm			850 mm		
Weight (cables not included)		46 kg		51 kg	48 kg		53 kg
Repeatability	Joints #1, #2	±0.025 mm					
	Joint #3	±0.010 mm					
	Joint #4	±0.005 deg					
Max. motion range	Joint #1	±152 deg	±107 deg		±152 deg		±107 deg
	Joint #2	±152.5 deg	±130 deg		For Clean/Protected models ±152.5 deg below Z = -360 ~ -390 deg ±151 deg		
	Joint #3 Std	180 mm/420 mm					
	Joint #3 Clean	150 mm/390 mm					
	Joint #4	±360 deg					
Payload	Rated	5 kg					
	Maximum	10 kg					
Standard cycle time <sup>1</sup>		0.34 sec			0.37 sec		
Joint #4 allowable moment of inertia <sup>2</sup>	Rated	0.020 kg•m <sup>2</sup>					
	Maximum	0.250 kg•m <sup>2</sup>					
Joint #3 downward force		250 N					
Electric lines		24 (9-Pin D-Sub, 15-Pin D-Sub)					
Pneumatic lines		Φ4 mm × 2, Φ6 mm × 2					
Installation environments		Standard/Cleanroom ISO Class 3 with ESD/Protected IP54 and IP65					
Available controllers		RC700A					
Safety standards		CE Mark: EMC Directive, Machinery Directive, RoHS Directive UL1740 ANSI/RIA R15.06 NFPA 79					

<sup>1</sup> Cycle time based on round-trip arch motion (300 mm horizontal, 25 mm vertical) with 2 kg payload (path coordinates optimized for maximum speed).

<sup>2</sup> When payload center of gravity is aligned with Joint #4; if not aligned with Joint #4, set parameters using the INERTIA command.

# G20



Scan Here for  
CAD Drawings

## Ultra long reach and heavy payload

- Arm lengths of 850 and 1,000 mm
- Unique design structure for high rigidity
- Tabletop, wall- and ceiling-mount models available
- Cleanroom ISO Class 3 and Protected IP65 models available



### SPECIFICATIONS

		G20-85x			G20-A0x		
Mounting type		Tabletop	Ceiling	Wall	Tabletop	Ceiling	Wall
Arm length	Arm #1 + #2	850 mm			1,000 mm		
Weight (cables not included)		48 kg		53 kg	50 kg		55 kg
Repeatability	Joints #1, #2	±0.025 mm					
	Joint #3	±0.010 mm					
	Joint #4	±0.005 deg					
Max. motion range	Joint #1	±152 deg	±107 deg		±152 deg		±107 deg
	Joint #2	±152.5 deg	±130 deg		For Clean/Protected models ±152.5 deg below Z = -360 ~ -390 deg ±151 deg		
	Joint #3 Std	180 mm/420 mm					
	Joint #3 Clean	150 mm/390 mm					
	Joint #4	±360 deg					
	Payload	Rated	10 kg				
Maximum		20 kg					
Standard cycle time <sup>1</sup>		0.37 sec			0.42 sec		
Joint #4 allowable moment of inertia <sup>2</sup>	Rated	0.050 kg•m <sup>2</sup>					
	Maximum	0.450 kg•m <sup>2</sup>					
Joint #3 downward force		250 N					
Electric lines		24 (9-Pin D-Sub, 15-Pin D-Sub)					
Pneumatic lines		Φ4 mm × 2, Φ6 mm × 2					
Installation environments		Standard/Cleanroom ISO Class 3 with ESD/Protected IP54 and IP65					
Available controllers		RC700A					
Safety standards		CE Mark: EMC Directive, Machinery Directive, RoHS Directive UL1740 ANSI/RIA R15.06 NFPA 79					

<sup>1</sup> Cycle time based on round-trip arch motion (300 mm horizontal, 25 mm vertical) with 2 kg payload (path coordinates optimized for maximum speed).

<sup>2</sup> When payload center of gravity is aligned with Joint #4; if not aligned with Joint #4, set parameters using the INERTIA command.

# Why Epson 6-Axis Robots?



**Epson's space-saving 6-Axis robots** enable a remarkable range of motion to maximize application possibilities.

## World's first folding-arm design

- Epson's innovative N-Series offers significant advantages in motion and workspace efficiency

## Proven technology

- Epson 6-Axis robots utilize the same controls, software and motion technologies found in our industry-leading SCARA robots

## SlimLine design

- Saves valuable factory floorspace and allows our robots to fit where other robots can't—without compromising power, speed or reach
- Compact wrist pitch enables our robots to access hard-to-reach places in confined spaces

# 6-AXIS



## VT-Series All-in-One

**VT-Series** All-in-One 6-Axis robots feature great performance at an ultra low price, offering many of the same features as Epson high-end robots. VT-Series robots include a built-in controller and simplified cabling, allowing fast, easy integration.



## N-Series

The **N-Series** lineup features a revolutionary compact folding-arm design that maximizes motion efficiency for faster cycle times. Packed with unique technology, the N-Series significantly reduces workspace requirements when compared to typical 6-Axis robots.



## C-Series

**C-Series** 6-Axis robots provide great cycle times and a unique SlimLine design, backed by remarkable precision and motion range. These compact robots offer exceptional performance for even the most demanding and complex applications.



# VT-Series All-in-One

**With a built-in controller and simplified cabling,** VT-Series All-in-One 6-Axis robots offer quick setup and installation. Featuring 110 V and 220 V power connections or a DC-powered version, they ensure easy integration—whether in a lab, an industrial environment or a mobile application.

# VT-SERIES

## 6-AXIS ROBOTS

ALL  
IN  
ONE  
BUILT-IN CONTROLLER



VT6L

A feature-packed performer at a remarkably low cost



### VT-SERIES ALL-IN-ONE SPECIFICATIONS

		VT6L
Arm length		920 mm
Repeatability	Joints #1 – #6	±0.100 mm
Payload	Rated	3 kg
	Maximum	6 kg
Standard cycle time <sup>1</sup>		0.60 sec
Installation environments		Standard/Cleanroom ISO Class 4/Protected IP67
Available controllers		Built-in

<sup>1</sup> Cycle time based on round-trip arch motion (300 mm horizontal, 25 mm vertical).

# VT-SERIES ALL-IN-ONE 6-AXIS ROBOTS

## VT6L



Scan Here for  
CAD Drawings



### Full-featured, ultra low cost

- Arm length of 900 mm
- Payloads up to 6 kg
- Built-in controller
- Available with 110 V and 220 V power or as a DC-powered version

### SPECIFICATIONS

	VT6-A901 (VT6L)			VT6-A901-DC (VT6L-DC)
Mounting type	Tabletop	Ceiling	Wall	Tabletop
Degree of freedom	6			6
Arm length	P Point: through the center of J4/J5/J6 920 mm			920 mm
Wrist flange surface	1,000 mm			1,000 mm
Weight (cables not included)	40 kg			40 kg
Repeatability	Joints #1 – #6 ±0.100 mm			±0.100 mm
Max. motion range	Joint #1	±170 deg/±170 deg/±30 deg		±170 deg/±170 deg/±30 deg
	Joint #2	-160 ~ +65 deg (225 deg)		-160 ~ +65 deg (225 deg)
	Joint #3	-51 ~ +190 deg (241 deg)		-51 ~ +190 deg (241 deg)
	Joint #4	±200 deg		±200 deg
	Joint #5	±125 deg		±125 deg
	Joint #6	±360 deg		±360 deg
Payload	Rated	3 kg		3 kg
	Maximum	6 kg		6 kg
Standard cycle time <sup>1</sup>	0.60 sec			0.60 sec
Allowable moment of inertia <sup>2</sup>	Joint #4	0.300 kg•m <sup>2</sup>		0.300 kg•m <sup>2</sup>
	Joint #5	0.300 kg•m <sup>2</sup>		0.300 kg•m <sup>2</sup>
	Joint #6	0.100 kg•m <sup>2</sup>		0.100 kg•m <sup>2</sup>
Standard I/O	In: 24/Out: 16			In: 24/Out: 16
Installation environments	Standard/ Cleanroom ISO Class 4/ Protected IP67	Standard		Standard
Available controllers	Built-in			Built-in
Safety standards	CE Mark: EMC Directive, Machinery Directive, RoHS Directive ANSI/RIA R15.06-2012 NFPA 79 (2007 Edition)			CE Mark: EMC Directive, Machinery Directive, RoHS Directive ANSI/RIA R15.06-2012 NFPA 79 (2007 Edition)
Power	110 and 220 VAC			48 VDC

<sup>1</sup> Cycle time based on round-trip arch motion (300 mm horizontal, 25 mm vertical) with 2 kg payload (path coordinates optimized for maximum speed).

<sup>2</sup> If the center of gravity is at the center of each arm. If the center of gravity is not at the center of each arm, set the eccentric quantity using the INERTIA command.



# 6-AXIS



SCARA Robots

6-Axis Robots

Controllers

| Epson RC+ Software | Integrated Solutions |

Options



# N-Series

**The N-Series offers revolutionary technology** that provides significant advantages for more efficient workspace utilization than typical 6-Axis robots. Packed with unique technology exclusive to Epson, N-Series robots set a new standard in 6-Axis technology with the world's first folding-arm design.

# N-SERIES

## 6-AXIS ROBOTS



N2

World's first folding-arm design, ideal for assembly and parts handling



N6

Higher payloads and longer reach for load/unload applications



### N-SERIES SPECIFICATIONS

		N2	N6
Arm length		450 mm	850/1,000 mm
Repeatability	Joints #1, #2	±0.02 mm	±0.030 mm/±0.040 mm
Payload	Rated	1 kg	3 kg
	Maximum	2.5 kg	6 kg
Installation environments		Standard	Standard/Cleanroom ISO Class 5 with ESD
Available controllers		RC700A	

# N-SERIES 6-AXIS ROBOTS

## N2



Scan Here for  
CAD Drawings



### Space-saving, revolutionary design

- Arm length of 450 mm
- Payloads up to 2.5 kg
- World's first compact folding-arm design
- Reduces required workspace area vs. standard 6-Axis robots
- Maximizes motion efficiency for faster cycle times

### SPECIFICATIONS

		N2-A450	
Mounting type		Tabletop	Ceiling
Degree of freedom		6	
Arm length	P Point: through the center of J4/J5/J6	450 mm	
Wrist flange surface		507 mm	
Weight (cables not included)		19 kg	
Repeatability	Joints #1 – #6	±0.020 mm	
Max. motion range	Joint #1	±180 deg	
	Joint #2	±180 deg	
	Joint #3	±180 deg	
	Joint #4	±195 deg	
	Joint #5	±130 deg	
	Joint #6	±360 deg	
Payload	Rated	1 kg	
	Maximum	2.5 kg	
Allowable moment of inertia <sup>1</sup>	Joint #4	0.200 kg•m <sup>2</sup>	
	Joint #5	0.200 kg•m <sup>2</sup>	
	Joint #6	0.080 kg•m <sup>2</sup>	
Electric lines		15 (15-Pin: D-Sub), 8 (8-Pin: RJ45) Cat5e	
Pneumatic lines		Φ6 mm × 2	
Installation environment		Standard	
Available controllers		RC700A	
Safety standards		CE Mark: EMC Directive, Machinery Directive, RoHS Directive ANSI/RIA R15.06-2012 NFPA 79 (2007 Edition)	

<sup>1</sup> If the center of gravity is at the center of each arm. If the center of gravity is not at the center of each arm, set the eccentric quantity using the INERTIA command.

# 6-AXIS

## N6



Scan Here for  
CAD Drawings



### Long reach, revolutionary design

- Arm lengths of 850 and 1,000 mm
- Payloads up to 6 kg
- World's first folding-arm design
- Ideal for confined spaces and load/unload applications

### SPECIFICATIONS

		N6-A85x	N6-A10x
Mounting type		Ceiling	Tabletop/Ceiling
Degree of freedom		6	6
Arm length	P Point: through the center of J4/J5/J6	850 mm	1,000 mm
Wrist flange surface		960 mm	1,110 mm
Weight (cables not included)		64 kg	69 kg
Repeatability	Joints #1 – #6	±0.030 mm	±0.040 mm
Max. motion range	Joint #1	±180 deg	
	Joint #2	±180 deg	
	Joint #3	±180 deg	
	Joint #4	±200 deg	
	Joint #5	±125 deg	
	Joint #6	±360 deg	
Payload	Rated	3 kg	3 kg
	Maximum	6 kg	6 kg
Allowable moment of inertia <sup>1</sup>	Joint #4	0.420 kg•m <sup>2</sup>	
	Joint #5	0.420 kg•m <sup>2</sup>	
	Joint #6	0.140 kg•m <sup>2</sup>	
Electric lines		15 (15-Pin: D-Sub), 8 (8-Pin: RJ45) Cat5e	
Pneumatic lines		Φ6 mm × 2	
Installation environment		Standard	
Available controllers		RC700A	
Safety standards		CE Mark: EMC Directive, Machinery Directive, RoHS Directive ANSI/RIA R15.06-2012 NFPA 79 (2007 Edition)	

<sup>1</sup> If the center of gravity is at the center of each arm. If the center of gravity is not at the center of each arm, set the eccentric quantity using the INERTIA command.



# C-Series

**With exceptional flexibility and a slim, compact design,** C-Series robots provide an innovative solution for 6-Axis applications. Their small footprint makes them ideal for factories that need to save space. And their long arms enable them to access hard-to-reach areas in the workplace.

# C-SERIES

## 6-AXIS ROBOTS



C4

Compact robots with high repeatability and fast cycle times



C8

Powerful robots with long reach and heavy payloads



C12

High-performance robots with heavy payload and second-generation GYROPLUS Technology



### C-SERIES SPECIFICATIONS

		C4	C8	C12
Arm length		600/900 mm	700/900/1,400 mm	1,400 mm
Repeatability	Joints #1 – #6	±0.020/±0.030 mm	±0.020/±0.030/±0.050 mm	±0.050 mm
	Rated	1 kg	3 kg	3 kg
Payload	Maximum	4 kg (5 kg with arm-downward positioning)	8 kg	12 kg
	Standard cycle time <sup>1</sup>	0.37/0.47 sec	0.31/0.35/0.53 sec	0.50 sec
Installation environments		Standard/Cleanroom ISO Class 3 and 4 with ESD	Standard/Cleanroom ISO Class 3 and 4 with ESD/Protected IP67	Standard/Cleanroom ISO Class 4 with ESD
Available controllers		RC700A		

<sup>1</sup> Cycle time based on round-trip arch motion (300 mm horizontal, 25 mm vertical) with 1 kg payload (path coordinates optimized for maximum speed).

# C-SERIES 6-AXIS ROBOTS

## C4



Scan Here for  
CAD Drawings



## High speed and exceptional flexibility

- Arm lengths of 600 and 900 mm
- Payloads up to 4 kg
- Slim design and compact wrist—fits in tight spaces
- Cleanroom ISO Class 3 models available

### SPECIFICATIONS

		C4-A601 (C4)		C4-A901 (C4L)	
Mounting type		Tabletop	Ceiling	Tabletop	Ceiling
Degree of freedom		6			
Arm length	P Point: through the center of J4/J5/J6	600 mm		900 mm	
Wrist flange surface		665 mm		965 mm	
Weight (cables not included)		27 kg		29 kg	
Repeatability	Joints #1 – #6	±0.020 mm		±0.030 mm	
Max. motion range	Joint #1	±170 deg			
	Joint #2	-160 ~ +65 deg			
	Joint #3	-51 ~ +225 deg			
	Joint #4	±200 deg			
	Joint #5	±135 deg			
	Joint #6	±360 deg			
Payload	Rated	1 kg			
	Maximum	4 kg			
Standard cycle time <sup>1</sup>		0.37 sec		0.47 sec	
Allowable moment of inertia <sup>2</sup>	Joint #4	0.150 kg•m <sup>2</sup>			
	Joint #5	0.150 kg•m <sup>2</sup>			
	Joint #6	0.100 kg•m <sup>2</sup>			
Electric lines		9-Pin (D-Sub)			
Pneumatic lines		Φ4 mm × 4			
Installation environments		Standard/Cleanroom ISO Class 3 with ESD			
Available controllers		RC700A			
Safety standards		CE Mark: EMC Directive, Machinery Directive, RoHS Directive UL1740 ANSI/RIA R15.06 NFPA 79			

<sup>1</sup> Cycle time based on round-trip arch motion (300 mm horizontal, 25 mm vertical) with 1 kg payload (path coordinates optimized for maximum speed).

<sup>2</sup> If the center of gravity is at the center of each arm. If the center of gravity is not at the center of each arm, set the eccentric quantity using the INERTIA command.



# C8/C12



Scan Here for  
CAD Drawings



## Long reach and heavy payload

- Arm lengths of 700, 900 and 1,400 mm
- Payloads up to 12 kg
- Slim design and compact wrist—fits in tight spaces
- Cleanroom ISO Class 3 (C8/C8L) and Class 4 (C8XL/C12XL) models available



## SPECIFICATIONS

	C8-A701 (C8)	C8-A901 (C8L)	C8-A1401 (C8XL)	C12XL-A1401 (C12XL)
Mounting type	Tabletop/Ceiling/Wall			Tabletop
Degree of freedom	6			
Arm length	P Point: through the center of J4/J5/J6			
	711 mm	901 mm	1,400 mm	1,400 mm
Wrist flange surface	791 mm	981 mm	1,480 mm	1,480 mm
Weight (cables not included)	49 kg (Protected: 53 kg)	52 kg (Protected: 56 kg)	62 kg (Protected: 66 kg)	63 kg
Repeatability	Joints #1 – #6			
	±0.02 mm	±0.03 mm	±0.05 mm	±0.05 mm
Max. motion range	Joint #1			
	±240 deg			
	Joint #2		-135 ~ +55 deg	
	-158 ~ +65 deg			
	Joint #3			
	-61 ~ +202 deg			
	Joint #4			
	±200 deg			
	Joint #5			
	±135 deg			
	Joint #6			
	±360 deg			
Payload	Rated			
	3 kg			
	Maximum			
	8 kg			12 kg
Standard cycle time <sup>1</sup>	0.31 sec	0.35 sec	0.53 sec	0.50 sec
Allowable moment of inertia <sup>2</sup>	Joint #4			
	0.470 kg•m <sup>2</sup>			0.700 kg•m <sup>2</sup>
	Joint #5			
	0.470 kg•m <sup>2</sup>			0.700 kg•m <sup>2</sup>
	Joint #6			
	0.150 kg•m <sup>2</sup>			0.200 kg•m <sup>2</sup>
Electric lines	15-Pin (D-Sub), 8-Pin (RJ45), 6-Pin (for Force Sensor)			
Pneumatic lines	Φ6 mm x 2			
Installation environments	Standard/Cleanroom ISO Class 3 with ESD/Protected IP67			Standard/Cleanroom ISO Class 4 with ESD
Available controllers	RC700A			
Safety standards	CE Mark: EMC Directive, Machinery Directive, RoHS Directive UL1740 ANSI/RIA R15.06 NFFA 79			CE Mark: EMC Directive, Machinery Directive, RoHS Directive ANSI/RIA R15.06 NFFA 79

<sup>1</sup> Cycle time based on round-trip arch motion (300 mm horizontal, 25 mm vertical) with 1 kg payload (path coordinates optimized for maximum speed).

<sup>2</sup> If the center of gravity is at the center of each arm. If the center of gravity is not at the center of each arm, set the eccentric quantity using the INERTIA command.

# Robot Controllers

**Compact and intuitive**, Epson controllers make automation configuration easy. Designed for use with both SCARA and 6-Axis robots, Epson's lineup provides advanced servo control for smooth motion and precise positioning. With integrated options available such as Vision Guidance, Force Guidance, Conveyor Tracking and more, Epson controllers provide true solution-based expandability.



# CONTROLLERS



All-in-One

Space-saving design with built-in controllers at an ultra low price

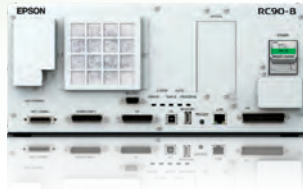

RC90B

Great performance at an affordable price



RC700A

Powerful feature set with ultra fast processing



RC700D

High-performance controller for our most advanced SCARA robots

## Advanced controllers to meet your automation needs

- **Powerful performance, compact design**
  - built for space-constrained environments; able to support everything from simple to high-end robots
- **Supports both SCARA and 6-Axis robots**
  - simplifies the lineup with common platforms
- **Full lineup of both SCARA and 6-Axis controllers**
  - choose the one best suited for your application
- **Easy to configure/setup**
  - front access (RC90B, RC700A and RC700D); intuitive panel; consolidated controls, all on one side, for easy changeouts
- **Advanced servo control system**
  - enables the robot to quickly perform smooth, precise motions
- **Slots for optional components**
  - supports a wide variety of fully integrated options

## All-in-One

Space-saving design,  
ultra low cost

- Supports TB-Series SCARA and VT-Series 6-Axis robots
- Comes standard with 110 V and 220 V power
- Use as standalone, PLC slave or with a PC
- Wide variety of integrated options including Vision Guide, IntelliFlex Feeding System, .Net connectivity, Ethernet/IP®, DeviceNet®, PROFIBUS and more



### ● SYSTEM CAPABILITIES



# RC90B

## Great performance at an affordable price

- Supports LSB-Series SCARA robots
- Use as standalone, PLC slave or with a PC
- Wide variety of integrated options including Vision Guide, Force Guide, IntelliFlex Feeding System, .Net connectivity, Ethernet/IP, DeviceNet, PROFIBUS, Expansion I/O, Conveyor Tracking and more



## SYSTEM CAPABILITIES

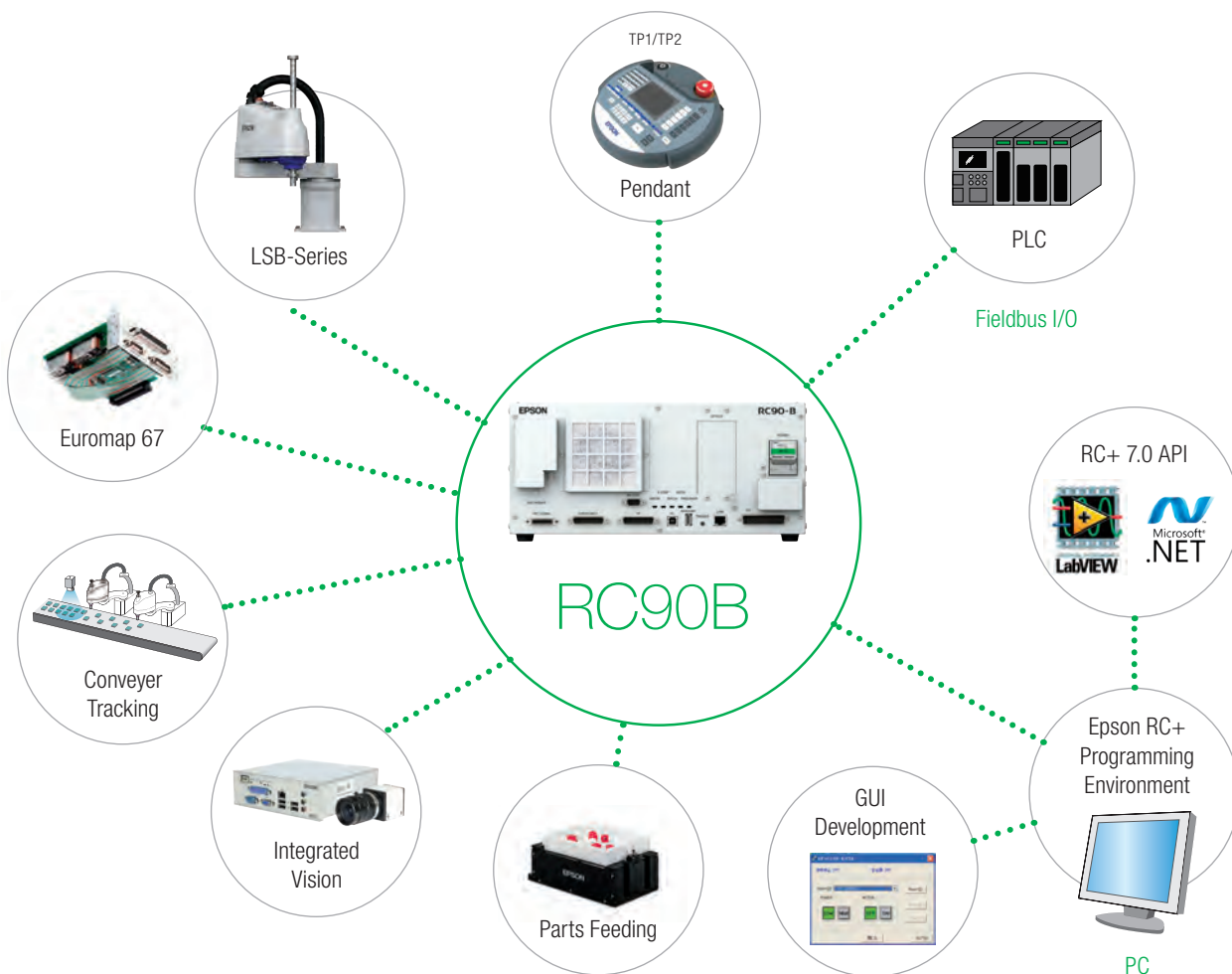

## RC700A

### Powerful performance with ultra fast processing

- Supports G- and RS-Series SCARA and C- and N-Series 6-Axis robots
- Use as standalone, PLC slave or with a PC, as well as Modules
- Wide variety of integrated options including Vision Guide, Force Guide, IntelliFlex Feeding System, .Net connectivity, Ethernet/IP, DeviceNet, PROFIBUS, Expansion I/O, Conveyor Tracking and more



### SYSTEM CAPABILITIES

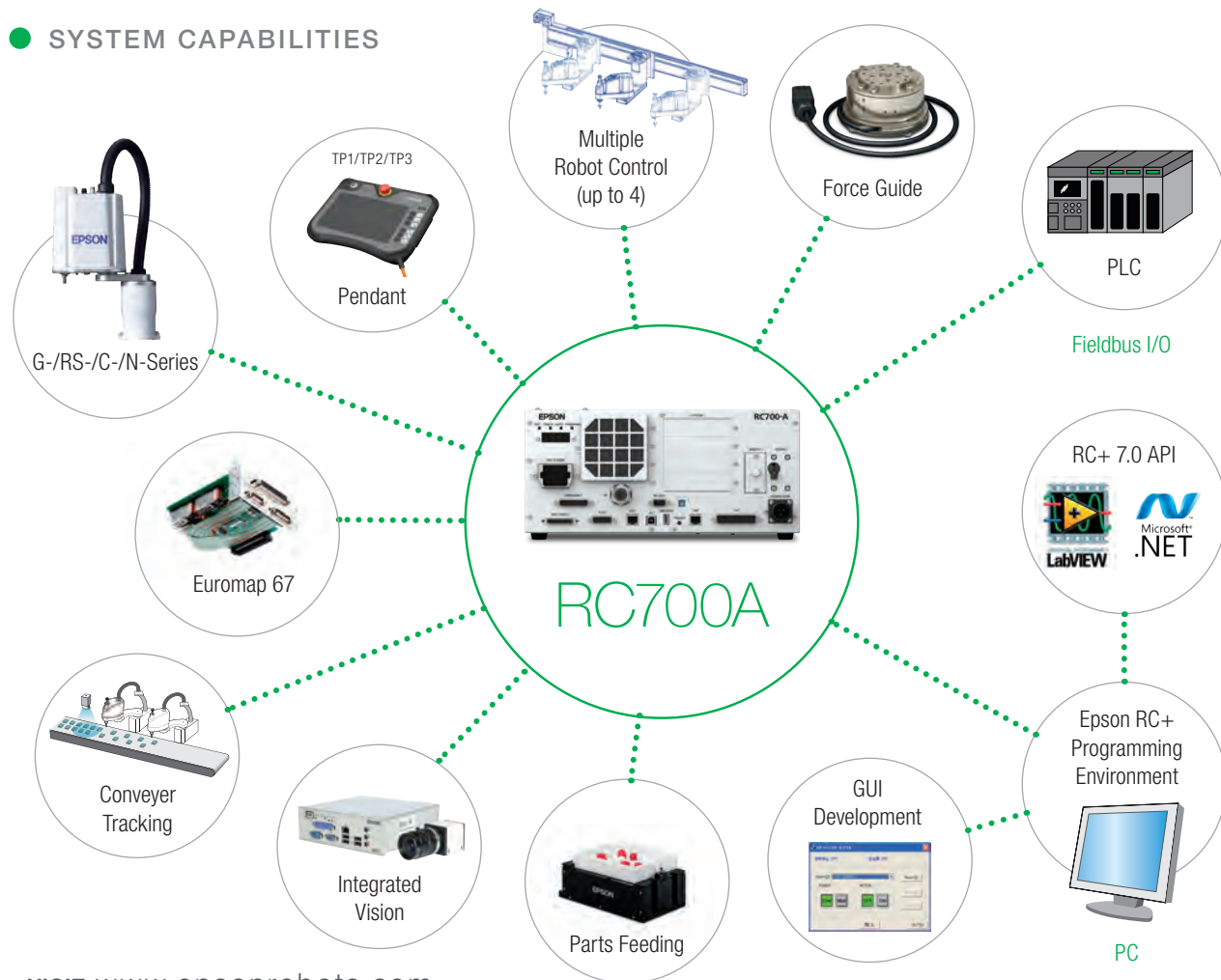

# RC700D

## High-performance controller for our most advanced SCARA robots

- Supports GX-Series SCARA robots
- Use as standalone, PLC slave or with a PC, as well as Modules
- Wide variety of integrated options, including Vision Guide, Force Guide, IntelliFlex Feeding System, .Net connectivity, Ethernet/IP, DeviceNet, PROFIBUS, Expansion I/O, Conveyor Tracking and more

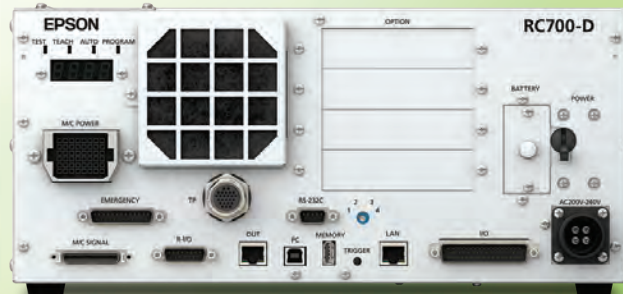

### SYSTEM CAPABILITIES

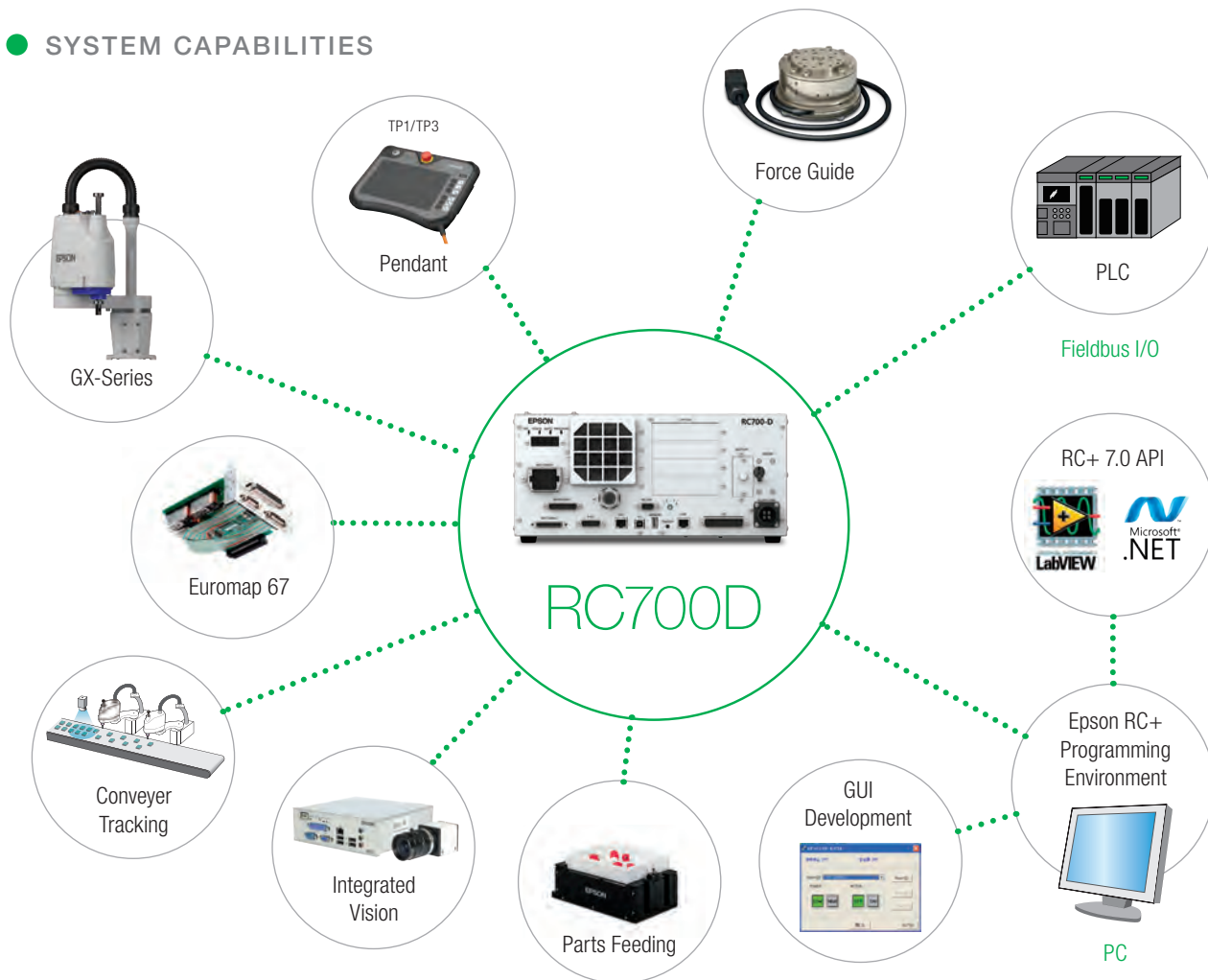

# ROBOT CONTROLLERS

## ● SPECIFICATIONS

Model		All-in-One		RC90B	
Robot manipulator control	Programming language and robot control software	Epson RC+ 7.x Epson RC+ Express 1.x		Epson RC+ 7.x Epson RC+ Express 1.x	
	Joint control	Up to six (6) joints simultaneous control, Software AC servo control		Up to four (4) joints simultaneous control, Software AC servo control	
	Speed control	PTP motion: Programmable in the range of 1% to 100% CP motion: Programmable (actual value to be manually entered)		PTP motion: Programmable in the range of 1% to 100% CP motion: Programmable (actual value to be manually entered)	
	Acceleration/ deceleration control	PTP motion: Programmable in the range of 1% to 100% Automatic CP motion: Programmable (actual value to be manually entered)		PTP motion: Programmable in the range of 1% to 100% Automatic CP motion: Programmable (actual value to be manually entered)	
	Number of manipulators	1		1	
Positioning control	PTP (Point-To-Point)/CP (Continuous Path)		PTP (Point-To-Point)/CP (Continuous Path)		
Memory capacity	Maximum object size: 8MB Point data area: 1,000 points (per file) Backup variable area: Max. 400KB (includes the memory area for the management table) Approx. 4,000 variables (depends on the size of array variables)		Maximum object size: 8MB Point data area: 1,000 points (per file) Backup variable area: Max. 400KB (includes the memory area for the management table) Approx. 4,000 variables (depends on the size of array variables)		
External input/output signals (standard)	Standard Input Output	VT-Series: Input: 24/Output: 16 TB-Series: In: 18/Out: 12/ Hand: In: 6/Out: 4	Including 8 inputs, 8 outputs with remote function assigned; assignment change allowed	Input: 24 Output: 16	Including 8 inputs, 8 outputs with remote function assigned; assignment change allowed
	Standard I/O drive unit	—		—	
Communication interface (standard)	Ethernet	1 channel		1 channel	
	USB	1 port		1 port	
Option boards (special slot)	I/O	—		Input: 24 per board Output: 16 per board	Maximum of 2 boards allowed
	Analog I/O	—		1 channel	
	Euromap 67	—		Input: 15 per board/Output: 16 per board	
	RS-232C	—		2 channels/board	Maximum of 2 boards allowed
	Fieldbus I/O slave	PROFINET PROFIBUS-DP DeviceNet CC-Link Ethernet/IP EtherCAT®	Maximum of 1 board allowed	1 channel/board PROFINET PROFIBUS-DP DeviceNet CC-Link Ethernet/IP EtherCAT	Maximum of 1 board allowed
	Pulse generator	—		4 axes/board	Maximum of 2 boards allowed
Option boards (PCI or PCIe slots)	Fieldbus I/O master	PROFIBUS-DP DeviceNet Ethernet/IP	—	1 channel/board PROFIBUS-DP DeviceNet Ethernet/IP	Maximum of 1 board allowed
Security	Password-based protection levels can be set to restrict access to some parts of the Epson RC+ system, helping prevent accidental or unauthorized alteration of control programs when multiple operators need to have access to basic controls. Keeps a log of changes made to source code.				
Safety features	Emergency stop switch / Safety door input / Low power mode / Dynamic brake / Encoder cable disconnection error detection / Motor overload detection / Irregular motor torque (out-of-control Manipulator) detection / Motor speed error detection / Positioning overflow - servo error - detection / Speed overflow - servo error - detection / CPU irregularity detection / Memory check-sum error detection / Overheat detection at the Motor Driver Module / Relay welding detection / Over-voltage detection / AC power supply voltage reduction detection / Temperature error detection / Fan error detection		Emergency stop switch / Safety door input / Low power mode / Dynamic brake / Encoder cable disconnection error detection / Motor overload detection / Irregular motor torque (out-of-control Manipulator) detection / Motor speed error detection / Positioning overflow - servo error - detection / Speed overflow - servo error - detection / CPU irregularity detection / Memory check-sum error detection / Overheat detection at the Motor Driver Module / Relay welding detection / Over-voltage detection / AC power supply voltage reduction detection / Temperature error detection / Fan error detection		
Power source	AC 110 V to AC 220 V/Single phase 50/60 Hz		AC 200 V to AC 240 V/Single phase 50/60 Hz		
Weight	Varies per robot model		7.5 kg		



# CONTROLLERS

RC700A		RC700D	
Epson RC+ 7.x Epson RC+ Express 1.x (not supported with N- and RS-Series)		Epson RC+ 7.x Epson RC+ Express 1.x	
Up to six (6) joints simultaneous control, Software AC servo control		Up to six (6) joints simultaneous control, Software AC servo control	
PTP motion: Programmable in the range of 1% to 100% CP motion: Programmable (actual value to be manually entered)		PTP motion: Programmable in the range of 1% to 100% CP motion: Programmable (actual value to be manually entered)	
PTP motion: Programmable in the range of 1% to 100%; Automatic CP motion: Programmable (actual value to be manually entered)		PTP motion: Programmable in the range of 1% to 100%; Automatic CP motion: Programmable (actual value to be manually entered)	
4		1	
PTP (Point-To-Point)/CP (Continuous Path)		PTP (Point-To-Point)/CP (Continuous Path)	
Maximum object size: 8MB Point data area: 1,000 points (per file) Backup variable area: Max. 400KB (includes the memory area for the management table) Approx. 4,000 variables (depends on the size of array variables)		Maximum object size: 8MB Point data area: 1,000 points (per file) Backup variable area: Max. 400KB (includes the memory area for the management table) Approx. 4,000 variables (depends on the size of array variables)	
Input: 24 Output: 16	Including 8 inputs, 8 outputs with remote function assigned; assignment change allowed	Input: 24 Output: 16	Including 8 inputs, 8 outputs with remote function assigned; assignment change allowed
Input: 24 Output: 16	Per drive unit	—	—
1 channel		1 channel	
1 port		1 port	
Input: 24 per board Output: 16 per board	Maximum of 4 boards allowed	Input: 24 per board Output: 16 per board	Maximum of 4 boards allowed
1 channel		1 channel	
Input: 15 per board/Output: 16 per board		Input: 15 per board/Output: 16 per board	
2 channels/board	Maximum of 2 boards allowed	2 channels/board	Maximum of 2 boards allowed
1 channel/board PROFINET PROFIBUS-DP DeviceNet CC-Link Ethernet/IP EtherCAT	Maximum of 1 board allowed	1 channel/board PROFINET PROFIBUS-DP DeviceNet CC-Link Ethernet/IP EtherCAT	Maximum of 1 board allowed
4 axes/board	Maximum of 4 boards allowed	4 axes/board	Maximum of 4 boards allowed
1 channel/board PROFIBUS-DP DeviceNet Ethernet/IP	Maximum of 1 board allowed	1 channel/board PROFIBUS-DP DeviceNet Ethernet/IP	Maximum of 1 board allowed
Password-based protection levels can be set to restrict access to some parts of the Epson RC+ system, helping prevent accidental or unauthorized alteration of control programs when multiple operators need to have access to basic controls. Keeps a log of changes made to source code.			
Emergency stop switch / Safety door input / Low power mode / Dynamic brake / Encoder cable disconnection error detection / Motor overload detection / Irregular motor torque (out-of-control Manipulator) detection / Motor speed error detection / Positioning overflow - servo error - detection / Speed overflow - servo error - detection / CPU irregularity detection / Memory check-sum error detection / Overheat detection at the Motor Driver Module / Relay welding detection / Over-voltage detection / AC power supply voltage reduction detection / Temperature error detection / Fan error detection		Emergency stop switch / Safety door input / Low power mode / Dynamic brake / Encoder cable disconnection error detection / Motor overload detection / Irregular motor torque (out-of-control Manipulator) detection / Motor speed error detection / Positioning overflow - servo error - detection / Speed overflow - servo error - detection / CPU irregularity detection / Memory check-sum error detection / Overheat detection at the Motor Driver Module / Relay welding detection / Over-voltage detection / AC power supply voltage reduction detection / Temperature error detection / Fan error detection	
AC 200 V to AC 240 V/Single phase 50/60 Hz		AC 200 V to AC 240 V/Single phase 50/60 Hz	
11 kg		11 kg	

# Development Software: Epson RC+ and Epson RC+ Express

Epson RC+ and Epson RC+ Express offer the ultimate selection of powerful, easy-to-use features, reducing the time needed to develop automated robot solutions. Epson RC+ advanced software includes fully integrated options such as Vision Guidance, Force Guidance, Conveyor Tracking, Parts Feeding and more. Epson RC+ Express features an easy-to-learn, block-style robot teaching environment, ideal for new users with little or no coding experience.



# SOFTWARE

SCARA Robots

6-Axis Robots

Controllers

Epson RC+ Software

Integrated Solutions

Options



## Epson RC+

Comprehensive suite of advanced tools and features in one convenient, integrated environment

## Epson RC+ Express

Intuitive, no-code, visual-based robot teaching environment

**The perfect choice for automation experts and new users alike, Epson makes it easy to create an array of industrial robot solutions with two powerful development environments.**

- Software options for simple or complex applications
- Easy-to-learn programming (Epson RC+) or no-code programming environment (Epson RC+ Express)
- Intuitive and easy to learn
- 3D simulator
- Quick deployment of your robotic system

# SOFTWARE

## Epson RC+ Express

### Get your robot system up and running fast

Epson RC+ Express is a simple, visual-based teaching environment built for users who are new to robot automation and have little to no programming experience.



## NO-CODE, EASY-TO-USE ROBOT TEACHING ENVIRONMENT

Get the power and flexibility of a scripted-text language with an easy-to-use robot programming environment. Epson RC+ Express is designed for use with Epson SCARA and 6-Axis robots, from the All-in-One T-Series and VT6L to the highest-performance G-, GX- and C-Series.

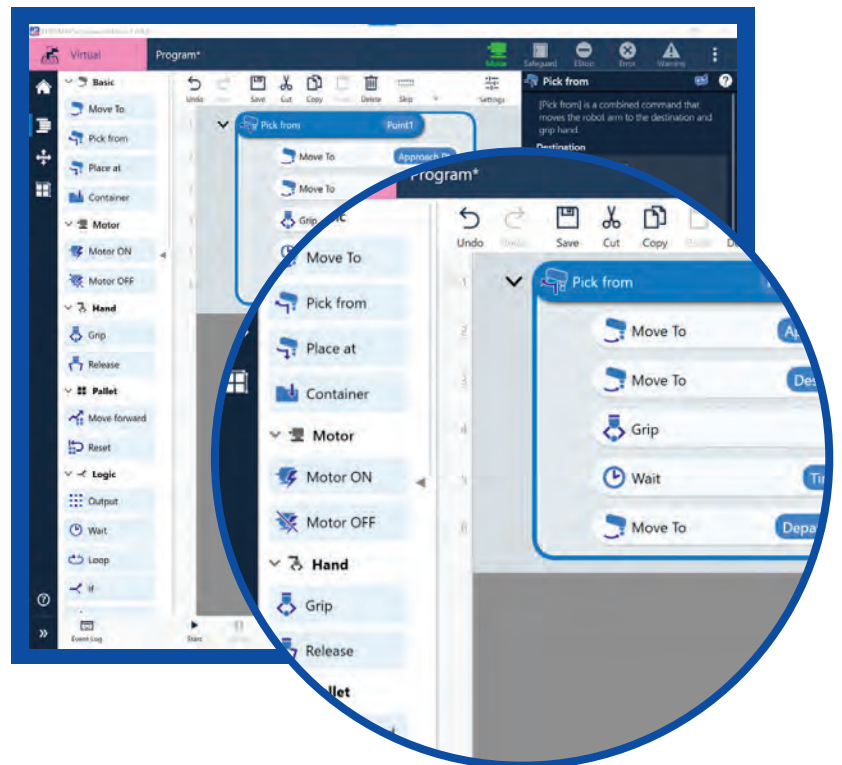

## SIMPLE TO NAVIGATE

Clear, intuitive, visual user interface makes it easy to learn and manage key functions, such as jogging, gripper control and motion. Take advantage of easy jog when manipulating 6-Axis robots, move effortlessly between linear and joint motion, and easily align the robot tool face to different planes with a single click.

Robot recovery has never been easier—by using the rollback feature after an event, the robot can be returned to a previous known position, allowing an easy restart to the system.



World position	Joint position	Arm orientation
X 400.000 mm	J1 0.000 deg	Rightly
Y 0.000 mm	J2 0.000 deg	
Z 0.000 mm	J3 0.000 mm	
U 0.000 deg	J4 0.000 deg	

## EXTENDED CAPABILITIES

Experienced Epson RC+ users can take advantage of the extended SPEL+ commands to simplify programs and complete more advanced tasks, while retaining the simple yet powerful Epson RC+ Express interface.

The optional Epson RC+ Project Link allows users to create advanced functions—such as Vision Guide or Force Guide—in Epson RC+ and then bring them into Epson RC+ Express programs. Additionally, Epson RC+ Express commands can be translated to the SPEL+ language, allowing easy transition from Epson RC+ Express to Epson RC+.

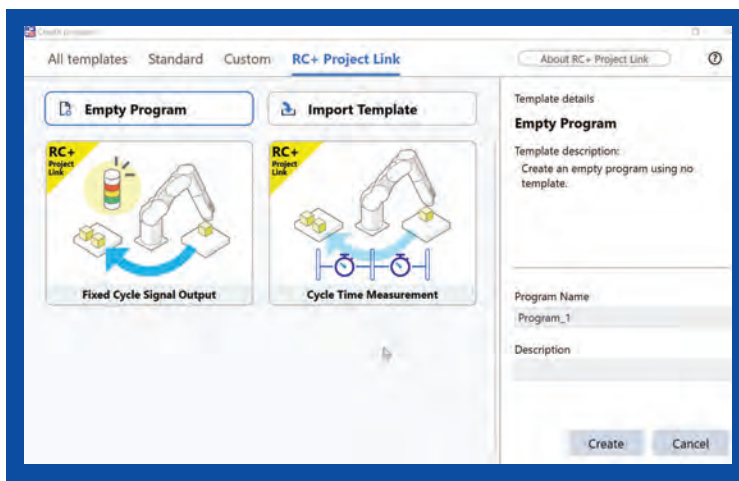

# SOFTWARE

## QUICK SETUP

Epson's proprietary Focus Assist technology provides quick-teach tools with auto-generated fields for fast application setup. Visual indicators highlight missing inputs to complete the function, such as quickly teaching a point. Wizards take users step-by-step to easily teach tools and pallets.

Once running, programs can be protected to reduce the risk of accidental program changes, all while allowing points to be re-taught to account for normal production variability.

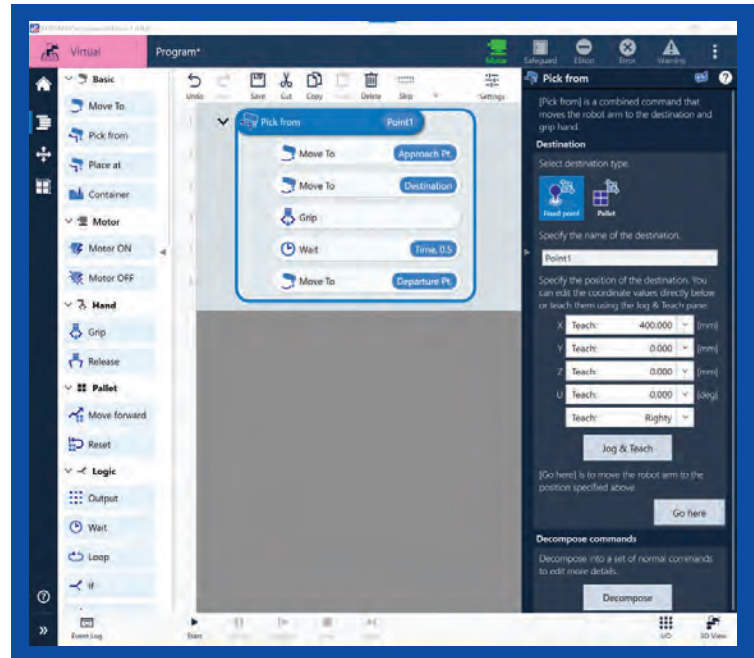

## COMMON APPLICATION TEMPLATES

Quickly create common applications, such as pick-and-place or palletizing and depalletizing, with premade, ready-to-use template programs. Learn on your own using the online tutorials with step-by-step instructions for Epson RC+ Express.

Templates are even provided for the optional Project Link, which allows the use of more advanced options, such as Vision Guide, Force Guide and Parts Feeding.

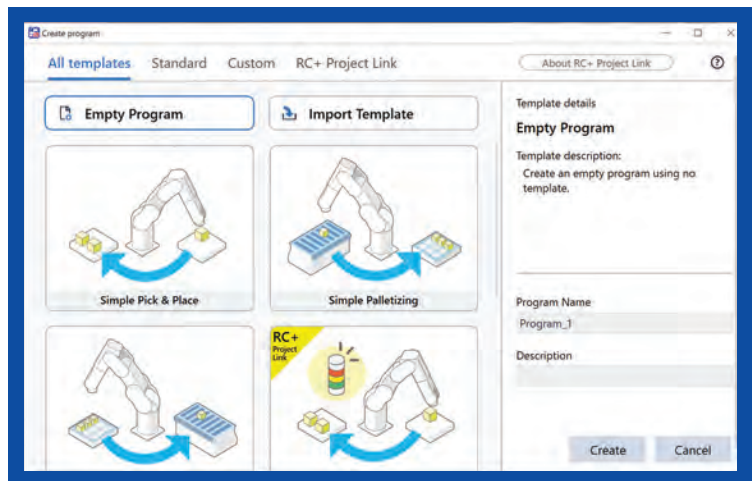

# SOFTWARE

## 3D SIMULATOR

Conveniently program and fine-tune applications with the built-in 3D simulator before your hardware has even arrived. Teach points, create motion commands and even simulate inputs and outputs to develop your application offline.

Rehearsal Mode allows the robot to be operated at low power and speed, and if an unexpected motion or action occurs, the robot can be stopped by lifting your finger from the touchpad, reducing risk of damage to the robot and the workcell.

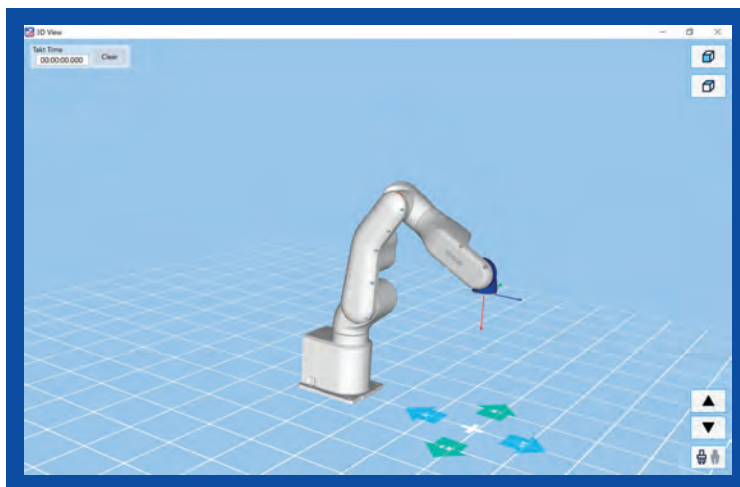

## TABLET-BASED WINDOWS OS ENVIRONMENT

Compatible with touchscreen devices to easily create robot applications. Drag and drop functions and easily change their order by sliding them around. Cut and paste commands and points to speed application development. Use sliders to easily configure the robot speed to meet your throughput requirements.



## Epson RC+

### The ultimate choice for robot system development

Epson RC+ offers a powerful set of tools and features that redefine automation efficiency. A comprehensive solution for virtually any application, Epson RC+ provides seamless integration, with all components working together in one integrated environment.



## All-inclusive development environment

- Projects
- Robot manager
- Task manager
- Run window
- Operator window
- Jog and teach window
- I/O monitor
- Offline development
- Wizards
- Project explorer
- Toolbar customization
- 3D simulator



# Auto-assist makes editing easier than ever

Epson RC+ includes powerful editing capabilities to minimize mistakes and streamline program development. In addition to basics such as cut, copy and paste, it also includes Syntax Assist, auto-indent, color-based command usage, comment blocks, indent/outdent, find/replace and more.

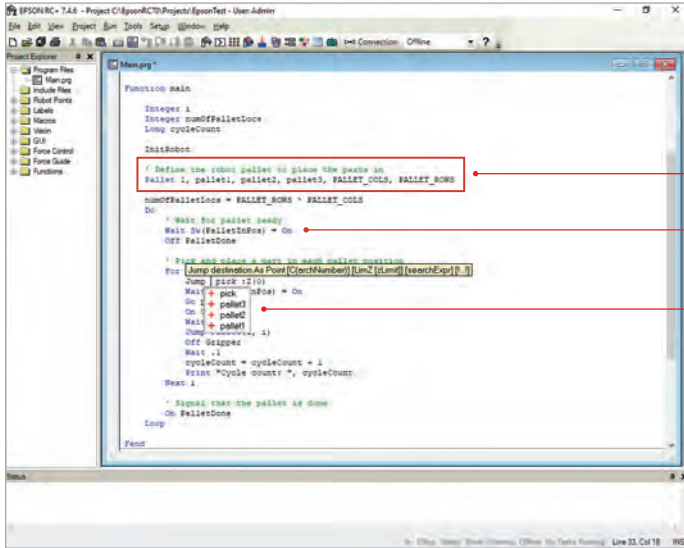

**Color-based editor** where keywords are blue, parameters are black, comments are green and incorrect syntax is red.

**Automatic indenting of code** contained in a function block for easy readability.

**Syntax Assist** helps users type or select the proper syntax for commands and their associated parameters.

## INTEGRATED DEBUGGER

# Easily identify issues in record time

The integrated debugger offers many clever ways to check the status of your program or identify issues you may find while running it. The Epson debugger allows you to check specified variables, view the value of those variables in real time, set break points, perform a single-step execution or jump over certain steps. You can also step into a function to view more details.

Run Window	F5
Test Auto Mode	Shift+F5
Step Into	F11
Step Over	F10
Walk	F12
Resume...	F7
Stop	
Toggle Breakpoint	F9
Clear All Breakpoints	Ctrl+Shift+F9
Display Variables...	
Call Stack...	F4

Easy-access menu and hot keys available for commonly used debugging tools.

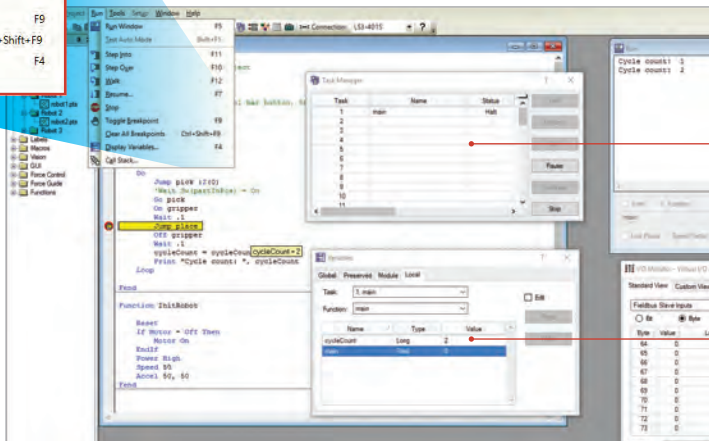

Task manager provides quick access to view status, start, stop, pause and continue Epson RC+ tasks.

Real-time display of local and/or global variables.

### Build and fine-tune your application before hardware setup

Take automation development to the next level with a virtual test run. Epson's workcell simulator means you can program your workcell, even before your hardware has arrived. See a 3D simulation of your application in action—in real time. You can even add additional components that may be a part of the workcell, such as a table, feeder or various types of guarding. Add a tool to the robot's arm and implement your program to examine the efficiency of the application.

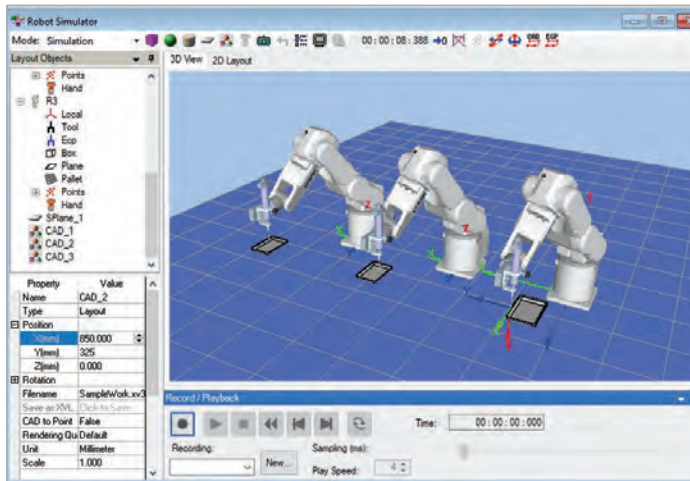

*Need to examine how multiple robots might affect productivity? Give it a test run with a detailed, simulated workcell.*

Full-featured simulator supports up to three robots and peripherals such as guarding, tools, parts and more.

#### Cycle-time calculation

- Calculate cycle time based on real application execution

#### Offline application checking

- Program can be created and debugged from standalone PCs
- Debugged programs can be rolled out directly to plant floor workcells

#### Machine vision simulation

- Machine vision image processing input can also be used within simulations

#### Record and playback functions

- Recording and playback functions make it easy to include still images and movies in presentations

#### Clearance checking

- Choosing the right robot is easy because you can check all necessary workcell and peripheral equipment

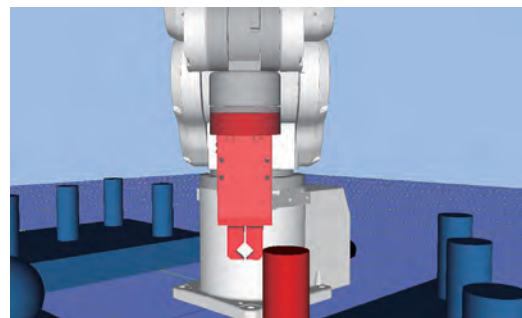

Vision Guide simulation supported with Epson RC+ 7.0

## SPEL+ ROBOT LANGUAGE

Epson's SPEL+ is a powerful yet easy-to-learn-and-use programming language for robot automation applications. With 500+ commands and statements, including motion functions, I/O control, variables and data types, program control and more, SPEL+ can be used for both complex and simple applications.

### Example Program

```
Function main
  Motor On           *turn motor power on
  Power High        *Power mode set high
  Speed 100         *Speed 100%
  Accel 100, 100    *Acceleration/Deceleration 100%

  If Sw(partok) = On Then *Checking if good part
    Jump goodparts      *move arm to goodpart pile
  Else
    Jump badparts       *move arm to bad part pile
  Endif

Fend
```

## INTEGRATED ENVIRONMENT

### One source, one comprehensive solution

Epson software offers easy integration of Epson robots with various automation options, including Vision Guide, Force Guide, IntelliFlex Parts Feeding, Conveyor Tracking and more. Built as a comprehensive solution for any given application, it provides seamless integration, allowing all components to interface with one another in a single environment.

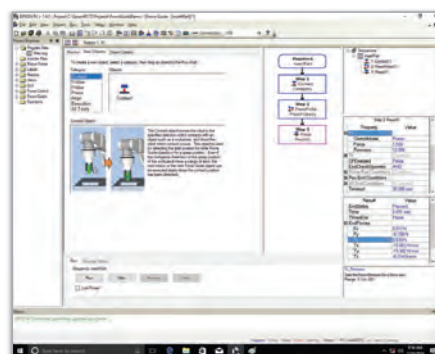
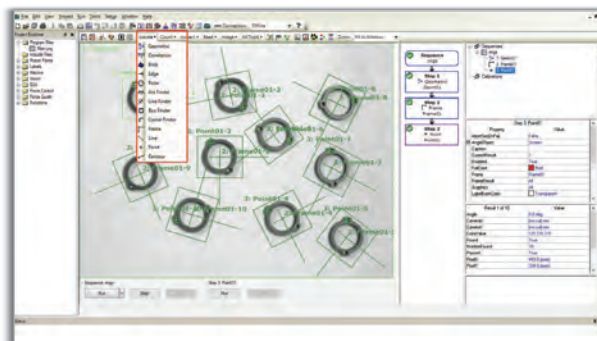

*Vision Guide and Force Guide are just two of the many integrated options available with Epson RC+.*

# Integrated Solutions

Enhance your robot automation solution with integrated options such as Vision Guide, Force Guide, IntelliFlex Parts Feeding and more. These powerful solutions make it easy to quickly build various applications without having to worry about peripheral communication setups and development from multiple environments. Instead, you can focus on maximizing the efficiency of your application.



# SOLUTIONS



## Vision Guide

Integrated vision guidance with easy configuration and collaboration



## IntelliFlex

High-performance parts-feeding solution with easy integration



## Force Guide

Intuitive robot force guidance for high-precision performance

# Vision guidance made easy

Epson Vision Guide makes precision robotic guidance easy to use. Fully integrated within the Epson RC+ development environment for easy configuration and calibration, this intuitive solution features a point-and-click interface that makes it simple for users of all levels. It also features wizards and auto calibration methods, plus a combination robot/vision simulator for rapid offline testing. With a common software environment for both robots and vision guidance, Epson Vision Guide allows for fast development and simplified maintenance. An efficient and versatile solution, it also includes tools for inspection, gauging, barcode reading and much more.

## Object Properties and Results

Users can easily input and adjust data; the software automatically generates associated results based on input parameters

**Vision Button**  
Launch Vision Guide directly from Epson RC+

- Locate ▾ Count ▾ Ins ▾
- Geometric
- Correlation
- Blob
- Edge
- Polar
- Arc Finder
- Line Finder
- Box Finder
- Corner Finder
- Frame
- Line
- Point
- Contour

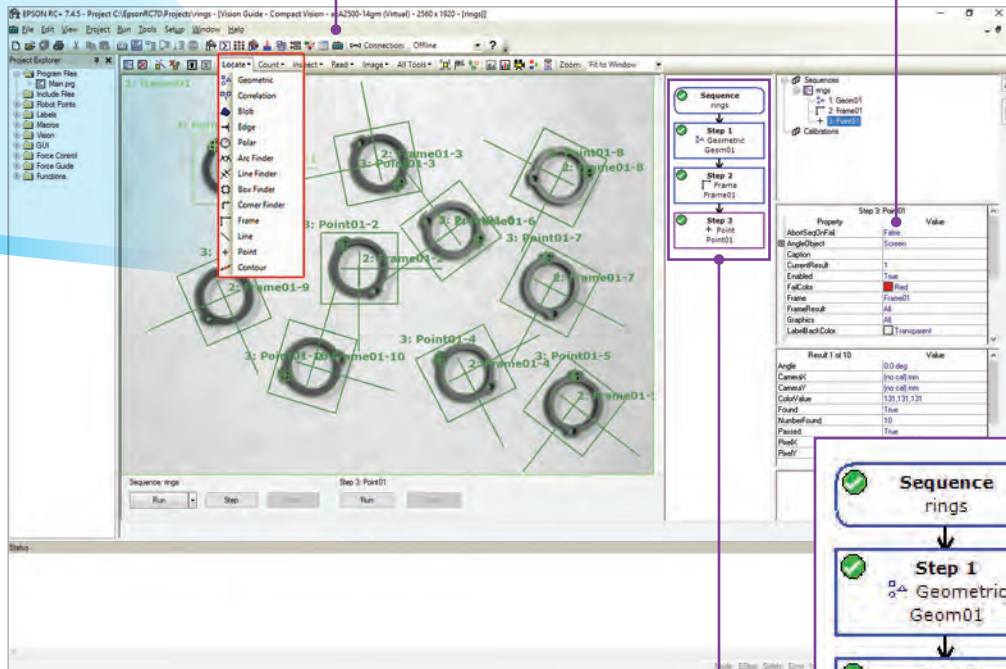

## Vision Objects

Drag and drop vision objects directly onto the image display window

## Flowchart

Sequence flowchart allows users to verify vision tools and adjust the step order for their application

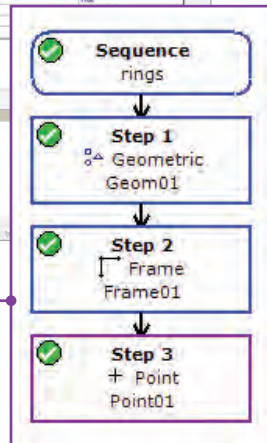

# True robot geometry-based calibration

Unlike common mapping-based calibration, Epson Vision Guide uses a powerful geometric-based calibration solution to improve the precision of camera-to-robot-coordinate system translation. Reduce calibration time and improve consistency with the integrated calibration wizard and easy step-by-step instructions. Multiple calibrations for both 6-Axis and SCARA robots, including fixed-downward, fixed-upward and those with mobile-joint-mounted cameras, are supported.

Fixed Downward



Fixed Upward



Mobile J2



Mobile J4



Mobile J5



Mobile J6

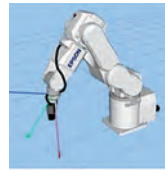

Standalone



SCARA AND 6-AXIS

SCARA

6-AXIS

NO ROBOT



# Versatile tool set



### Geometric

Finds a model based on geometric features. Used for determining position and orientation.



### Blob

Computes geometric, topological and other image features. Used for determining presence/absence, size, positioning and orientation.



### Correlation

Measures quality compared to previously trained features for alignment, inspection, position and orientation.



### Edge

Locates edges by identifying changes in grey value from dark to light or light to dark.



### ImageOp

Performs morphology, convolution, flip, binarize, rotate and more for a region of interest.



### Polar

Uses correlation of a rotational area to determine object orientation.



### OCR

Optical Character Recognition is used to recognize character strings in an image.



### CodeReader

Reads bar or two-dimensional codes, including data matrix and others.



### ColorMatch

Detects user-defined colors.



### LineFinder

Determines the location of a line in an image.



### LineInspector

Identifies deviations on a linear path between two points.



### ArcFinder

Determines the radius and center point of an arc or major/minor axes and the angle of an ellipse.



### ArcInspector

Determines abnormalities in the arc of a circle/ellipse.



### DefectFinder

Compares a template image to an input image to identify defects.



### Frame

Provides dynamic position reference for other vision objects.



### Line

Defines a line between two objects.



### Point

Defines reference positions for other objects.



### BoxFinder

Determines the center of an object.



### CornerFinder

Identifies the intersection position of two lines that form a corner.



### Contour

Generates a contour based on the external shape of an object.

# Full-featured, integrated solution

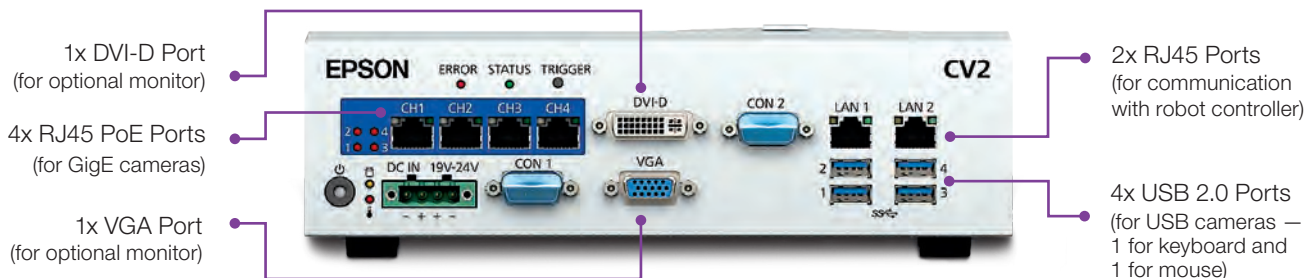



## ● SPECIFICATIONS

System		CV2SA	CV2HA	PV1
Robot controller		RC700A, RC90, RC90B, TB-Series, VT-Series		
Cameras supported (Epson cameras only)		GigE: Mono (0.3 MP, 1.3 MP, 2 MP, 5 MP, 10 MP and 20 MP) and Color (2 MP, 5 MP, 10 MP and 20 MP) USB: Mono (0.3 MP, 1.3 MP and 5 MP) and Color (1.3 MP, 5 MP)		
Vision tools		Locate: Geometric, Correlation, Blob, Edge, Polar, ArcFinder, LineFinder, BoxFinder, CornerFinder, Frame, Line, Point and Contour Count: Blob, Correlation, Geometric Inspect: Blob, DefectFinder, Line, LineInspector, ArcInspector and ColorMatch Read: CodeReader and OCR Image: ImageOp and Text		
Quantity of connectable cameras		Up to 6 cameras (2 USB and 4 GigE cameras)		Up to 8 GigE cameras
Image processing speed		Standard type	High-speed type	N/A
Safety standards		CE, UL, KC		N/A
Dimensions W x D x H (excluding rubber feet)		232 mm x 175 mm x 70 mm		N/A
Operating temperature and humidity		5 – 40 deg C, 20% – 80% (non-condensing)		N/A
Direction of installation		Horizontal or Vertical		N/A
Power source voltage		DC 19 V – 24 V		N/A
Rated electric current		11.57 A (at 19 V DC) – 9.16 A (at 24 V DC)		N/A
Weight		2.1 kg		N/A
Interface (connection)	Ethernet (for communication with Robot Controller)	RJ45: 4 ports (1000 Mbps); Power over Ethernet (PoE) supported; can connect to HUB or Switch		N/A
	Ethernet (for GigE camera)	RJ45: 4 ports (1000 Mbps); Power over Ethernet (PoE) supported		
	USB	USB 2.0: 4 ports (for USB Camera, USB Memory, Mouse, Keyboard)		
	Monitor connection	VGA: 1 port, DVI-D: 1 port (SXGA fixed) The 2 ports display the same output (mirror display)		
	CON1, CON2	Not available		
CV2 standard accessories		Mounting plates (1 set), power supply connector (1 pc), connector cap for CON (2 pcs)		N/A

# The smarter parts singulation solution

Powered by Epson robots, IntelliFlex Software and Vision Guide, the IntelliFlex Feeding System delivers a simplistic feeding solution to accommodate a wide variety of parts. Integrated with Epson RC+ Development Software, the IntelliFlex Feeding System offers easy setup and configuration. Its point-and-click interface helps reduce the typical development time required for advanced applications. With four feeder sizes available (IntelliFlex 80, 240, 380 and 530), the system can accommodate part sizes ranging from 3 mm to 150 mm. The IntelliFlex system also offers intelligent auto-tuning for fast setup and flexible parts changeover. And, multi-axis vibration technology provides optimized parts control and singulation.



**IntelliFlex 240**—Ideal for parts ranging from 5 mm – 40 mm



**IntelliFlex 80**—Ideal for parts ranging from 3 mm – 15 mm



## Point-and-click setup and configuration

Fully integrated with the Epson RC+ Development Software, the IntelliFlex Feeding System makes setup and configuration easier than ever. Featuring a point-and-click interface, it can help reduce development time for advanced applications, often taking it from weeks down to days.

### EPSON SYSTEM SETUP

1. **Vision Programming**
  - Built-in robot-to-vision calibration and point-and-click programming
2. **Parts Tuning**
  - Automatic parts tuning with vision feeder integration
3. **Parts Control Adjustment**
  - Configuration wizard for defining part separation pickup area and more

### TYPICAL SYSTEM SETUP

1. **Feeder Communications**
  - Low-level protocol using feeder command set
2. **Feeder Tuning**
  - Getting parts to move properly
3. **Vision Setup and Calibration**
  - Calibrating vision system to robot
4. **Vision Programming**
  - Finding parts reliably
5. **System Programming**
  - Robot + Feeder + Vision coordination
6. **Optimization**
  - Fine-tuning and performance optimization

Turn this...

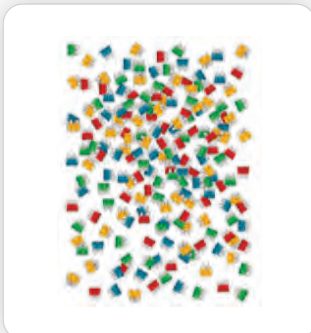

Into this...

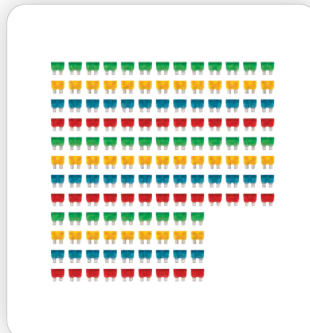

With this.



With multi-axis vibration technology, designed to optimize parts control.

# Precision parts calibration with smart auto-tuning

Epson RC+ Development Software also features an intuitive wizard to guide users through customized calibration. Step by step, this wizard automatically determines the exact values needed for optimum tuning and calibration.

## Part pickup regions maximize parts throughput

Easily set parameters specific to each part, no coding required

Configures feeder orientation to properly select the pickup area without needing to modify the physical application layout

Defines parts pickup area to optimize cycle time

## Parts calibration (tuning) wizard reduces tuning time

3 simple steps to set up calibration parameters

Integrated image display window to show part separation results

Automatically computes and displays the tuning parameters, vibration amplitude and vibration time

## IntelliFlex Feeding System

### FLEXIBLE FEEDER SPECIFICATIONS

Model Name	IntelliFlex 80	IntelliFlex 240	IntelliFlex 380	IntelliFlex 530
Model number	RIF80	RIF240	RIF380	RIF530
Part size dimensions	3 mm – 15 mm	5 mm – 40 mm	15 mm – 60 mm	30 mm – 150 mm
Max. surface load per feeder	0.05 kg	0.40 kg	1.5 kg	2.0 kg
Communication	Ethernet (TCP/IP)			
Power supply	24 V/6 A	24 V/8 A	24 V/20 A	24 V/20 A
Vibration platform (length x width)	65 mm x 52 mm	195 mm x 150 mm	254 mm x 325 mm	427 mm x 371 mm
Footprint (length x width x height)	320 mm x 65 mm x 140 mm	300 mm x 171 mm x 132 mm	499 mm x 257 mm x 307 mm	600 mm x 372 mm x 320 mm
Compatible robot series	SCARA: G-/LS-B-/RS-, TB-, GX-Series 6-Axis: C-/N-/VT-Series			
Vision integration	Vision Guide PV1 and CV2			
<b>Software Features</b>				
Max. # of feeders supported per robot controller (All-in-Ones)	2			
Max. # of feeders supported per robot controller (RC700A, RC700D & RC90B)	4			
Max. # of robots sharing the same feeder at the same time (RC700A with drive units only)	2			
Max. # of robots sharing the same feeder at the same time (RC90B & All-in-Ones)	1			
Max. # of unique parts per feeder running at the same time	4			
Max. # of parts per development environment project (Epson RC+)	32			
Purge software function (IntelliFlex 80 requires Purge Calibration)	Supported			
<b>Options</b>				
Purge hardware	Optional hardware required			
Integrated backlight options	White/Red/Infrared/Green/Blue			
Tray configuration options	ESD (Anti-static) Anti-stick Anti-rolling Medical Black			
Hopper sizes	0.16 L	2 L/3 L	10 L	15 L
What's in the box	Flexible Feeder, IntelliFlex Software, Power and Communication Cables			
Support	Customer Service (562) 290-5920 service@robots.epson.com Applications Support (562) 290-5930 applications@robots.epson.com Sales Inquiries (562) 290-5997 info@robots.epson.com			

# Intuitive robot force guidance for high-precision performance

**Powered by proprietary Epson Quartz Technology**, Epson Force Guide enables Epson robots to detect six axes of force with precision down to 0.1 N. Driven by real-time servo system integration, Force Guide delivers fast, tactile feedback to guide robots for high-precision parts placement. Easy to set up, Force Guide features a point-and-click interface with pre-configured solutions and built-in objects, reducing the development time for precision applications.



## Advantage Epson

**Drawing on our global expertise in robotic solutions**, Epson created Force Guide as a tool to achieve higher productivity in automated manufacturing processes. Epson Force Guide features proprietary Quartz Technology, which provides remarkable rigidity and powerful performance, allowing customers to complete automation tasks that were previously not possible.

- **Epson Quartz Technology**
- **High rigidity**
- **Powerful performance**

# Force Guide applications

**Force and torque sensors are an increasingly significant component** for material testing, assembly, development and quality assurance. Because of their accuracy, versatility and reliability, they are being used by more and more companies around the world. Epson Force Guide provides a wide range of automation possibilities:

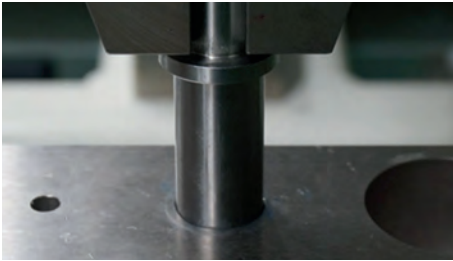

## Parts and connector insertion

With Epson Force Guide, parts and connector insertion can be easily automated for everything from pin-in-socket insertion to high-precision valve assembly. Epson sensors detect misalignment. And, because of high sensitivity, the part or connector is easily inserted, damage-free.

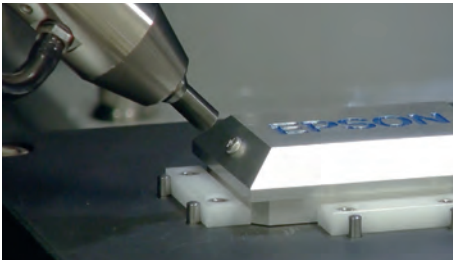

## Screw driving

Thanks to real-time force/torque feedback, the smallest of screws can be easily tightened, even when there is deviation in angle or location. By detecting the force, the robot can successfully execute the task while preventing any stripping of the threads.

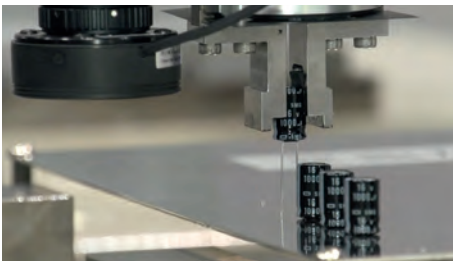

## Delicate parts handling

Because of its tight integration with the servo system, Epson Force Guide makes it easy to handle glass and other delicate materials. Our quartz-based sensors allow for soft placement in applications that would otherwise result in breakage of glass or other fragile materials.



## Grinding/polishing

Deburring and grinding of parts to accurately remove excess flash is possible with Epson Force Guide, despite deviations in casting or dimensions. The tool remains on its path, due to real-time force feedback. Similarly, polishing can be automated so as to keep the tool pressing with constant and precise force to the part.



## Gear meshing

On assembly operations, Epson Force Guide provides the robot with the tools and data necessary to align and match the faces of various components, including multiple gears.

# Force Guide tools

Pre-configured force guidance object tools provide a simple method for creating robot force-based motions and applications.



**1 CONTACT**  
Find the object



**4 FOLLOW**  
Move the robot based on the force detected

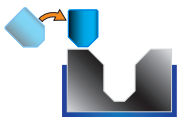

**2 ALIGN**  
Align the object, as needed



**5 PRESS**  
Continue to apply the necessary force to the object to complete placement of the part



**3 PROBE**  
Find the holes or steps needed

# Intuitive interface

Fully integrated in the Epson RC+ development environment, Epson Force Guide applications can be created and tested in an easy-to-use point-and-click fashion.

The screenshot shows the Epson RC+ software interface. On the left, a 'Category' list includes Contact, Follow, Probe, Press, Align, Execution, and All Tools. The main window displays a 'Sequence' flowchart with three steps: Step 1 (Contact), Step 2 (Press/Probe), and Step 3 (Press). A 'Property' table is visible on the right, showing parameters like ContactType, Force, Firmness, and Timeout. At the bottom left, a 3D preview shows a robot arm interacting with a green cylindrical object.

## Force Guide Sequence

The Force Guide sequence flowchart provides a simple drag-and-drop mechanism for defining the force guidance operational flow (ordering of steps). This reduces the amount of programming required for Force Guide applications.

## Object Properties and Results

Users can input and adjust force and torque data. The software automatically generates associated results based on input parameters.

## Object Function Preview

A graphical representation is shown to illustrate the robot motions associated with specific Force Guide tools.



## Real-time Force Guide monitoring

Epson Force Guide provides real-time graphical representations of both force and torque, allowing users to see and adjust force guidance based on object parameters. Epson Force Guide also provides visual feedback and records and displays data logs to ensure operational reliability.

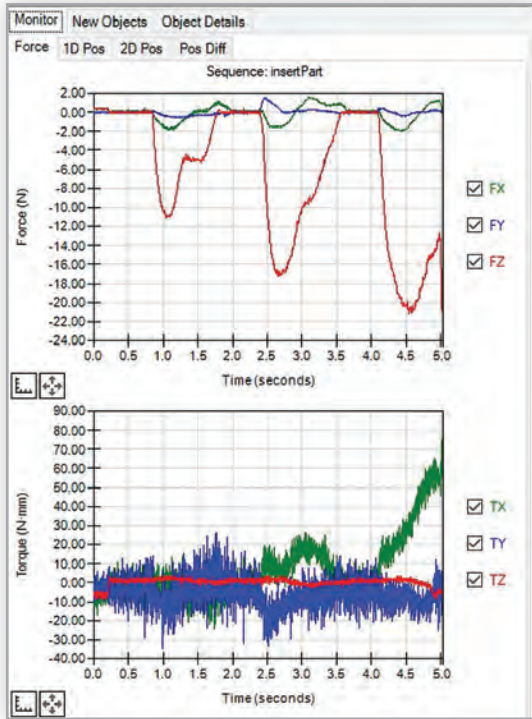

### SPECIFICATIONS

Model No.	S250N	S250L	S250P	SH250LH	S250H	S2503		S2506	S25010
Compatible robots <sup>1</sup>	C4	C8 (Standard, Clean/ESD) C12XL	C8 (Protected)	N6	N2	RS-Series	G3 GX4	G6 GX8	G10 G20
Cabling routing	External	Internal	Internal	Internal	Internal	Internal	External	Internal	Internal
Dimensions (diameter x height)	80 mm x 49 mm	88 mm x 49 mm	88 mm x 66 mm	85 mm x 48 mm	80 mm x 49 mm	80 mm x 52 mm		80 mm x 52 mm	80 mm x 52 mm
Weight <sup>2</sup>	460 g	520 g	680 g	460 g	460 g	620 g	620 g	620 g	640 g
Compatible robot controller <sup>3</sup>	RC700A, RC700D (GX4 and GX8)								
Measured degrees of freedom	6-Axis: 3 force components (Fx, Fy, Fz) and 3 torque components (Tx, Ty, Tz)								
Rated load	Force (Fx, Fy, Fz)					250 N			
	Torque (Tx, Ty, Tz)					18 Nm			
Maximum allowable static load	Force (Fx, Fy, Fz)					1,000 N			
	Torque (Tx, Ty, Tz)					36 Nm			
Measured resolution <sup>4</sup>	Force (Fx, Fy, Fz)					± 0.1 N or less (5 sec, 25 °C)			
	Torque (Tx, Ty, Tz)					± 0.003 Nm or less (5 sec, 25 °C)			
Measurement accuracy <sup>5</sup>	± 5% RO or less								
Operating environment	Temperature								
	Humidity								
Protection class	IP20	IP20	IP67	IP20	IP20	IP20	IP20	IP20	IP20
What's in the box	Force Sensor, Force Control Board, Cables								
Safety standards	CE Mark: EMC Directive, KC Mark								
Support	Customer Service (562) 290-5920 service@robots.epson.com Applications Support (562) 290-5930 applications@robots.epson.com Sales Inquiries (562) 290-5997 info@robots.epson.com								

1 Robots not supported: G1, LS-Series, TB-Series, EZ Modules.

2 Weight includes force sensor and mounting flange; does not include control board and cables.

3 Controllers not supported: RC90B and All-in-One.

4 The measurement resolution including the noise level and time drift (25 °C), when the measurement time is 5 seconds.

5 The measurement accuracy when the measurement time is 6 minutes.

# Options

From Vision Guide and Force Guide to GUI Builders, teach pendants conveyor tracking and fieldbus I/O, Epson offers the options you need to enhance your robot system.

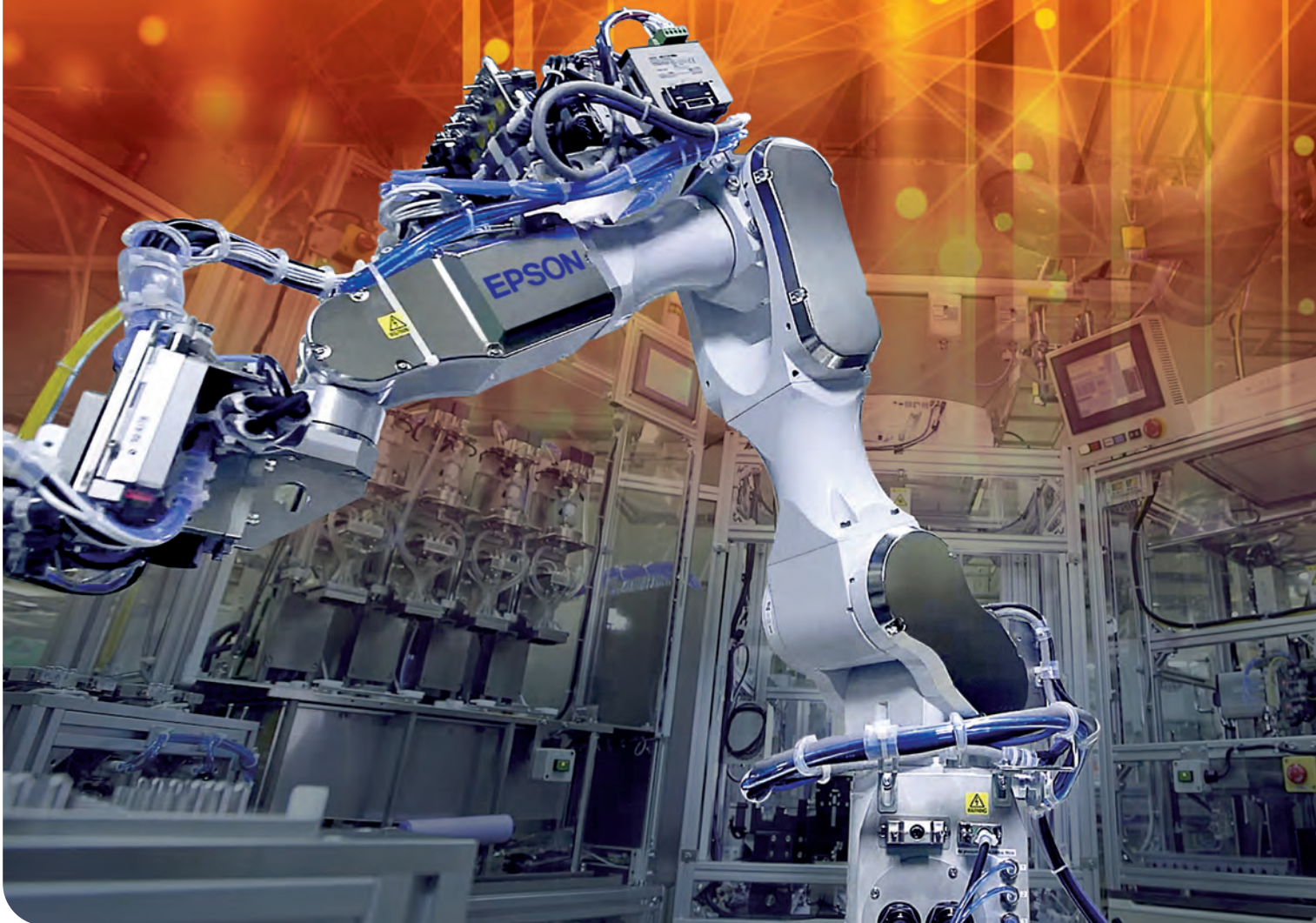

# OPTIONS

## SPECIFICATIONS

### Controller Options

	All-in-One (TB- and VT-Series)	RC90B (LSB-Series)	RC700A (G-, RS-, C-, N-Series)	RC700D (GX-Series)
Teach pendant (TP2)	●	●	●	—
Teach pendant (TP3)	●	—	●	●
Conveyor tracking	—	●	●	●
PG cards (external axis control)	—	●	●	●
Emergency stop switch	●	●	●	●
RS-232C cards	—	●	●	●
I/O expansion cards	—	●	●	●
Fieldbus I/O (slave)	●	●	●	●
Fieldbus I/O (master)	●	●	●	●
I/O cable kit	—	●	●	●
Analog I/O	—	●	●	●
Euromap 67	—	●	●	●
Force Guide	—	—	●	●
Parts Feeding	●	●	●	●

### Software Options

	All-in-One	RC90B	RC700A	RC700D
Vision Guide (7.0)	●	●	●	●
RC+ 7.0 API	●	●	●	●
ECP	●	●	●	●
GUI Builder 7.0	●	●	●	●
OCR	●	●	●	●
Add-On Instructions	●	●	●	●

### Robot Manipulator Options

	T3-B/ T6-B	LS3-B/ LS6-B/ LS10-B/ LS20-B	RS3/ RS4	G1	GX4/ GX8	G6/ G10/ G20	N2/N6	C4	C8/ C12XL	VT6L
External wiring units	—	—	—	—	●	●	—	—	—	●
Tool adapters/ISO flange	●	●	●	●	●	●	●	—	●	●
Brake release units	—	—	—	—	—	—	●	●	●	—
Power and signal cables	—	●	●	●	●	●	●	●	●	●
Camera mounting bracket	●	●	●	—	●	●	●	●	●	●
External drive units	—	—	●	●	—	●	—/●	●	●/—	—
UL 1740	—	—	●	●	●	●	—	●	●	—

# OPTIONS

## GUI Builder

### COMPATIBLE CONTROLLERS

All-in-One

RC90B

RC700A

RC700D

## Easily create a Graphical User Interface (GUI) for operators

- Fully integrated within Epson RC+ to reduce overall development time
- Create GUIs without Visual Studio or other third-party software tools
- Create and debug GUI forms from your Epson RC+ Project
- Form and Control Events are executed as SPEL+ tasks
- Perfect for novices and experts alike
- Works with RC700A, RC700D, RC90B and All-in-One controllers

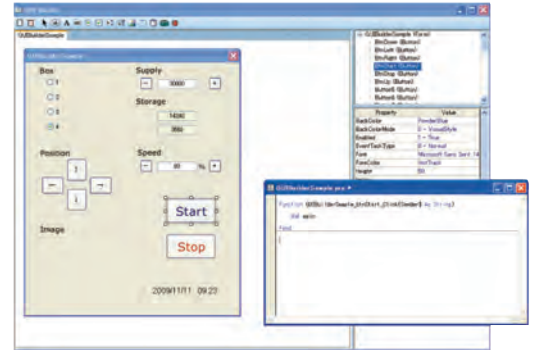

## The GUI Builder Window

**GUI Builder has five main areas of use** for creating and modifying user GUIs. These include: Toolbar Buttons, Design Area, Forms Explorer, Property Grid and Events Grid.

## GUI Builder area definitions

### ● DESIGN AREA

**Where forms are displayed at design time.**

Each opened form is displayed on its own tab. You can easily switch between forms by clicking on the tab or double-clicking the form in the Forms Explorer.

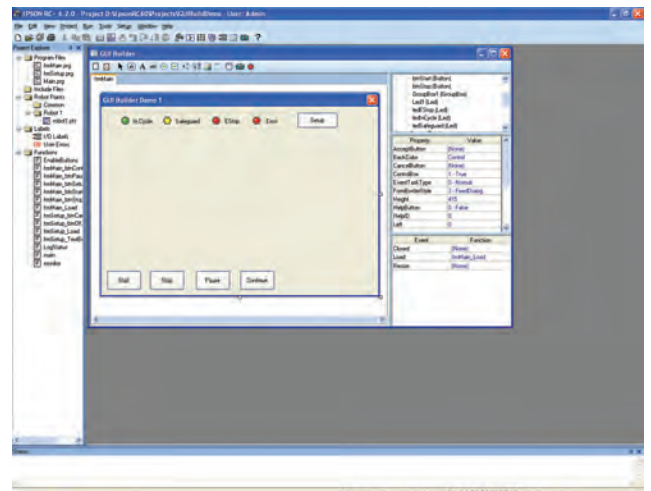

## Steps to Use GUI Builder

### STEP 1

Create a new form, click the Button control from the GUI Builder toolbar and drag it to the form.



### STEP 2

Double-click the button and the Code Editor will appear. Add the SPEL+ code you want to execute when the button is clicked from your application.

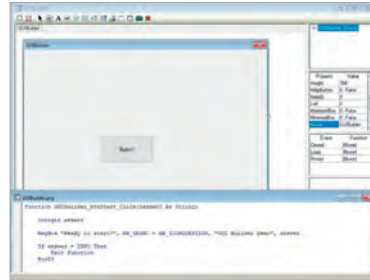

### STEP 3

Add more graphic components on your form and associated SPEL+ codes as required for your application.

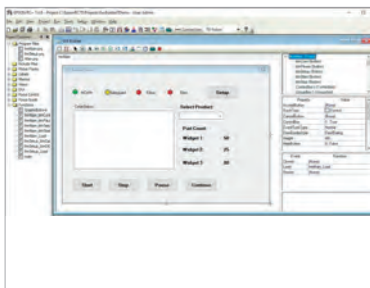

### STEP 4

Run the application from the Epson RC+ Run window or set it up to have the GUI come up automatically. You can also bring up Epson RC+ dialogs like the I/O monitor shown here.



### ● TOOLBAR BUTTONS

Contains the various controls to be put on a GUI Builder form. Many of the common controls are supported such as Button, Label, Textbox, Radio Button and Checkbox. However, there are also some controls unique to Epson that help reduce development time for items routinely needed for robot systems. Some of these unique controls include the Video Box control (to display the Vision Guide image) and the LED control (to interface with the Epson robot I/O).

### ● FORMS EXPLORER

A tree that contains each form for the current project and its associated controls. When a new form or control is created, it is added to the tree. Double-clicking on a form opens the form in its own tab in the design area.

### ● PROPERTY GRID

Used to display and edit forms and control properties. When you select a form or control, the associated properties are displayed in the grid. You can edit the values for properties, thus changing the characteristics of the specific control.

### ● EVENTS GRID

Used to display and change events for the associated form or control. Each event has a user function (written in SPEL+ code) that is called when the event occurs. This gives the user complete flexibility to program what happens when specific events occur.

# OPTIONS

## RC+ 7.0 API

COMPATIBLE CONTROLLERS

All-in-One

RC90B

RC700A

RC700D

### Program and execute robot applications in a familiar MS Windows OS environment

- Robots can be controlled using Visual Basic®, Visual C++®, Visual C#®, LabVIEW™ and other third-party programming languages
- Robot status and variable values can be captured
- Vision Guide integration for easy image display on user GUIs
- Third-party .Net interface and database design tools can also be used for program development
- The following Epson RC+ windows and dialogs can be called from within a .Net application:
  - Robot Manager
  - I/O Monitor
  - Task Manager
  - Maintenance Dialog
  - Simulator
  - Force Monitor

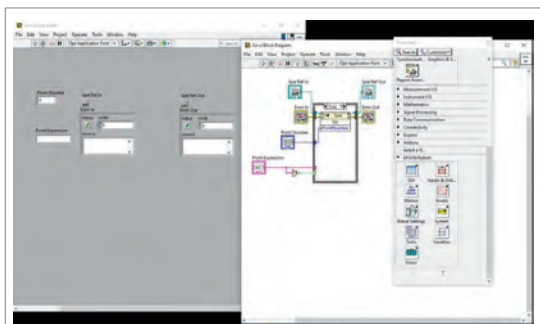

LabVIEW

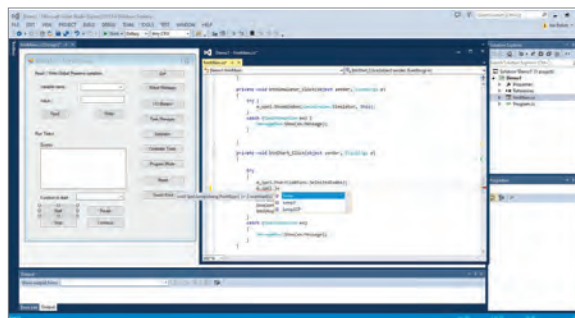

Visual C®

## Add-On Instructions (AOI) for Allen Bradley®

COMPATIBLE CONTROLLERS

RC90B

RC700A

RC700D

### For integration with systems using Allen Bradley PLC-based programming<sup>1</sup>

- Ideal for both basic and complex programming tasks—initiates simple solutions or highly structured programs, all with ladder-logic programming
- Single point of control—machine control via a PLC

<sup>1</sup> An Ethernet/IP board is required to enable communication between the robot controller and the programmable logic controller.



## Conveyor Tracking

COMPATIBLE CONTROLLERS

RC90B

RC700A

RC700D

### Precision tracking for high-productivity pick-and-place operation

- Supports vision- or sensor-based conveyor tracking
- Vision Guide software detects moving parts for pick-and-place handling
- Multi-conveyor, multi-tool setups are supported
- Automate manual kitting/packaging tasks and help maintain productivity with continuous conveyor operation; ideal for product assembly

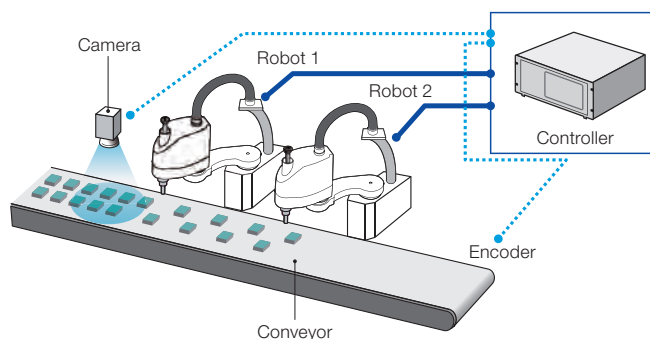

## Fieldbus I/O (Master)

COMPATIBLE CONTROLLERS

All-in-One RC90B RC700A RC700D

### Bidirectional high-speed peripheral connectivity

- Support for DeviceNet, PROFIBUS and Ethernet/IP networked peripherals (1,024-point I/O)
- Requires user PC for master board
- Must be connected to robot controller during operation

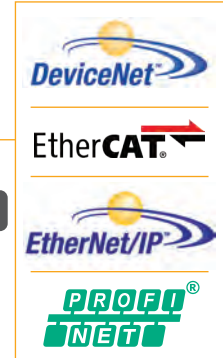

## Fieldbus I/O (Slave)

COMPATIBLE CONTROLLERS

All-in-One RC90B RC700A RC700D

### High-speed peripheral connectivity

- Support for DeviceNet, PROFIBUS, CC-Link®, Ethernet/IP, EtherCAT and PROFINET® networked peripherals (256-point I/O)

## Teach Pendant TP2

COMPATIBLE CONTROLLERS

All-in-One RC90B RC700A

### Easy-to-use pendant

- Universal design ensures ease of use for both right-handed and left-handed operators



## Teach Pendant TP3

COMPATIBLE CONTROLLERS

All-in-One RC700A RC700D

### Powerful pendant for both teaching and robot operation

- 10" color touchscreen panel
- 1280 x 800 high-definition screen resolution
- User-friendly GUI
- Ability to make robot parameter changes
- High-speed test mode
- IP65-rated enclosure is sealed against oil and dust for reliable operation in adverse conditions
- Shock-resistant construction helps protect unit from impact damage
- Universal design ensures ease of use for both right-handed and left-handed operators



# OPTIONS

## Camera Mounting Bracket

Easily mount cameras to robot arm

### COMPATIBLE ROBOT MANIPULATORS

G3	GX4	G6	GX8	G10	G20
LS3-B	LS6-B	LS10-B	LS20-B	RS3	RS4
T3-B	T6-B	N2	N6	C4	C8
C12	VT6L				

Bracket design varies according to robot; please specify model when ordering.



## OCR

### COMPATIBLE CONTROLLERS

All-in-One	RC90B	RC700A	RC700D
------------	-------	--------	--------

Optical Character Recognition (OCR) of text on parts and labels

- For use with optional Vision Guide system
- Enables you to specify the font, font size and number of characters of text that you want to read from an image
- A font creation function lets you create SEMI fonts and user-defined fonts from imaged characters or ASCII conversion files

## PG Motion System

### COMPATIBLE CONTROLLERS

RC90B	RC700A	RC700D
-------	--------	--------

Control peripheral devices for fully integrated process automation\*

- Epson RC+ Software and pulse generator (PG) cards enable control of multiple third-party drives and motors
- PG robots and standard Epson RC+ system robots can be operated simultaneously and controlled using the same commands
- PG cards can be used to control X/Y tables, slides, rotary tables and a wide range of other production/inspection line peripherals
- Each PG card has 4 channels and can support from 1 to 4 robots; up to 4 cards can be installed on the RC700A

\*Drivers and motors for third-party devices not included.

## ECP

### COMPATIBLE CONTROLLERS

All-in-One	RC90B	RC700A	RC700D
------------	-------	--------	--------

External Control Point (ECP) operation for precise positioning

- For processes requiring the workpiece to be moved against a fixed tool, external control points can be used to ensure precise positioning
- Up to 16 external control points can be set

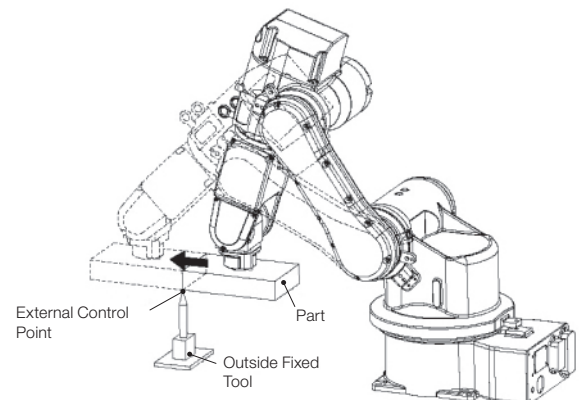



## RC700A DU Drive Unit

Control multiple robots with a single RC700A controller

COMPATIBLE ROBOT MANIPULATORS

G1

G3

G6

G10

G20

RS3

RS4

N6

C4

C8



## Emergency Cable Kit

Convenient wiring of the safety circuit

- Cable and connectors for easy connection of the emergency stop switch

COMPATIBLE CONTROLLERS

All-in-One

RC90B

RC700A

RC700D



## I/O Cable Kit

Cables and connectors for easy connectivity with no soldering required

- A wide range of I/O cables and connectors are available

COMPATIBLE CONTROLLERS

RC90B

RC700A

RC700D



## RS-232C Cards

Expanded Serial port connectivity

- 2-port RS-232C cards to connect to Serial interface devices

COMPATIBLE CONTROLLERS

RC90B

RC700A

RC700D



## I/O Expansion Cards

Expanded input/output flexibility

- 24 inputs/16 outputs per board

COMPATIBLE CONTROLLERS

RC90B

RC700A

RC700D



# OPTIONS

## External Wiring Units

Simplifies wiring when mounting end-effector options

- Enables easy, on-site connection of external wiring by users
- Ideal for connecting Vision Guide system camera cables or other wiring

### COMPATIBLE ROBOT MANIPULATORS

G6

GX8

G10

G20

VT6L



## Tool Adapters/ISO Flanges

Enhances handling/processing versatility and simplifies end-effector changes

### COMPATIBLE ROBOT MANIPULATORS

G1

G3

GX4

G6

GX8

G10

G20

LS3-B

LS6-B

LS10-B

LS20-B

RS3

RS4

T3-B

T6-B

N2

N6

C4L

C8

C8L

C8XL

C12XL

VT6L



## Brake Release Units

Releases brakes so robot arm can be moved by hand when power is off

### COMPATIBLE ROBOT MANIPULATORS

N2

N6

C4

C8

C12

## Euromap 67 Interface

Epson solution complies with Euromap 67, the standard for connection between injection molding and robots

### COMPATIBLE ROBOT MANIPULATORS

G1

G3

GX4

G6

GX8

G10

G20

LS3-B

LS6-B

LS10-B

LS20-B

RS3

RS4

N2

N6

C4

C4L

C8

C8L

C8XL

C12XL



# Certified Epson Robots Training Courses

Epson offers a wide variety of high-quality, certified courses designed to help you learn how to quickly and effectively program and operate our robot and vision products. Students can attend courses online or in-person at our Epson Training Center in California or at any of our regional Certified Training Centers. All courses are taught by Epson-certified instructors in a structured environment designed for hands-on learning.

## Available Courses

### Epson RC+ Core 1 Robot Training

Core 1 provides in-person instruction and hands-on labs to get students quickly comfortable using the Epson RC+ environment and Epson SPEL+ programming language, which is used on all Epson SCARA and 6-Axis robots.

### Epson RC+ Core 2 Advanced Robot Training

Core 2 focuses on integration of Epson robots into today's complex automation systems. Advanced use of motion control, logic and integration are emphasized in this two-day course.

### Epson Vision Guide Training

Designed to get users up and running with the Epson Vision Guide system to create vision sequences for robot motion guidance, inspection and gauging. In this two-day course, students will learn how to configure vision tools and objects and perform calibrations.

### Epson RC+ Express No-Code Robot Training

Epson RC+ Express training provides students with hands-on experience creating robotic applications using the latest no-code teaching environment from Epson. This one-day course is ideal for users who are new to automation.

## Contact Information

U.S. and Canada

Epson Robots  
3131 Katella Ave.  
Los Alamitos, CA 90720  
[epson.com/robottraining](http://epson.com/robottraining)





## Epson Business Solutions

Epson is a leading provider of innovative technology solutions that help businesses succeed.

We partner with you to best meet your specific needs, focusing on:

- Improved productivity
- World-class customer service and support
- Cost-effective, high-quality solutions
- A commitment to the environment

Discover how Epson can help you work toward the future. [www.epson.com/forbusiness](http://www.epson.com/forbusiness)

**Epson America, Inc.**  
3131 Katella Ave., Los Alamitos, CA 90720

**Epson Canada Limited**  
185 Renfrew Drive, Markham, Ontario L3R 6G3

[www.epson.com](http://www.epson.com)  
[www.epson.ca](http://www.epson.ca)  
[www.epsonrobots.com](http://www.epsonrobots.com)

**Better Products for a Better Future™**  
[eco.epson.com](http://eco.epson.com)

Specifications and terms are subject to change without notice. EPSON and Epson RC+ are registered trademarks, EPSON Exceed Your Vision is a registered logomark and Better Products for a Better Future is a trademark of Seiko Epson Corporation. IntelliFlex is a trademark of Epson America, Inc. Microsoft and Windows are either registered trademarks or trademarks of Microsoft Corporation in the United States and other countries. All other product and brand names are trademarks and/or registered trademarks of their respective companies. Epson disclaims any and all rights in these marks. Copyright 2022 Epson America, Inc. CPD-54833R3 10/22