

**HIGH BRIGHTNESS
LASER PROJECTORS**

EB-L1100U/L1200U/L1405U

EB-L1505UHNL/L1515SNL/L1715SNL/L1755UNL

EPSON
EXCEED YOUR VISION



**GO THE DISTANCE WITH LONGER
LASTING LASER PROJECTIONS.**

The Epson EB-L1000 series projector is designed to deliver unyielding laser performance, from any position to most surfaces, up to 20,000 long lasting hours – maintenance-free. Project 4K enhanced resolutions in confident colours with the intuitive colour correction system that compensates for uneven colour surfaces and screens. Every component is skilfully innovated with attention to detail in mind, including the integrated 3LCD technology that will provide you with stunning colour brightness for quality images.



EB-L1100U / L1200U



EB-L1405U / L1505UHNL /
L1515SNL / L1715SNL /
L1755UNL



Beyond Full HD Resolution



Powered Lens



Flexible Installation



Edge Blending



Camera Calibration



IT'S IN THE DETAILS.

3LCD technology that delivers quality projected images and reliable performance.

Unparalleled Performance

Guaranteed 20,000 hours of maintenance-free projections with laser light source supported by fully inorganic display engine.

Confident Colours, Greater Details

Detect and correct uneven screen colours, to project 4K enhanced images in magnificent hues and brilliant white, with the built-in camera.

Adaptive Projections

With the optional ultra short throw lens, rotate 360° and project on wide-curved, angled surfaces to create astounding images even in small spaces.



*Source: Futuresource Consulting.

HIGH BRIGHTNESS LASER PROJECTORS

EB-L1100U/L1200U/L1405U

EB-L1505UHNL/L1515SNL/L1715SNL/L1755UNL

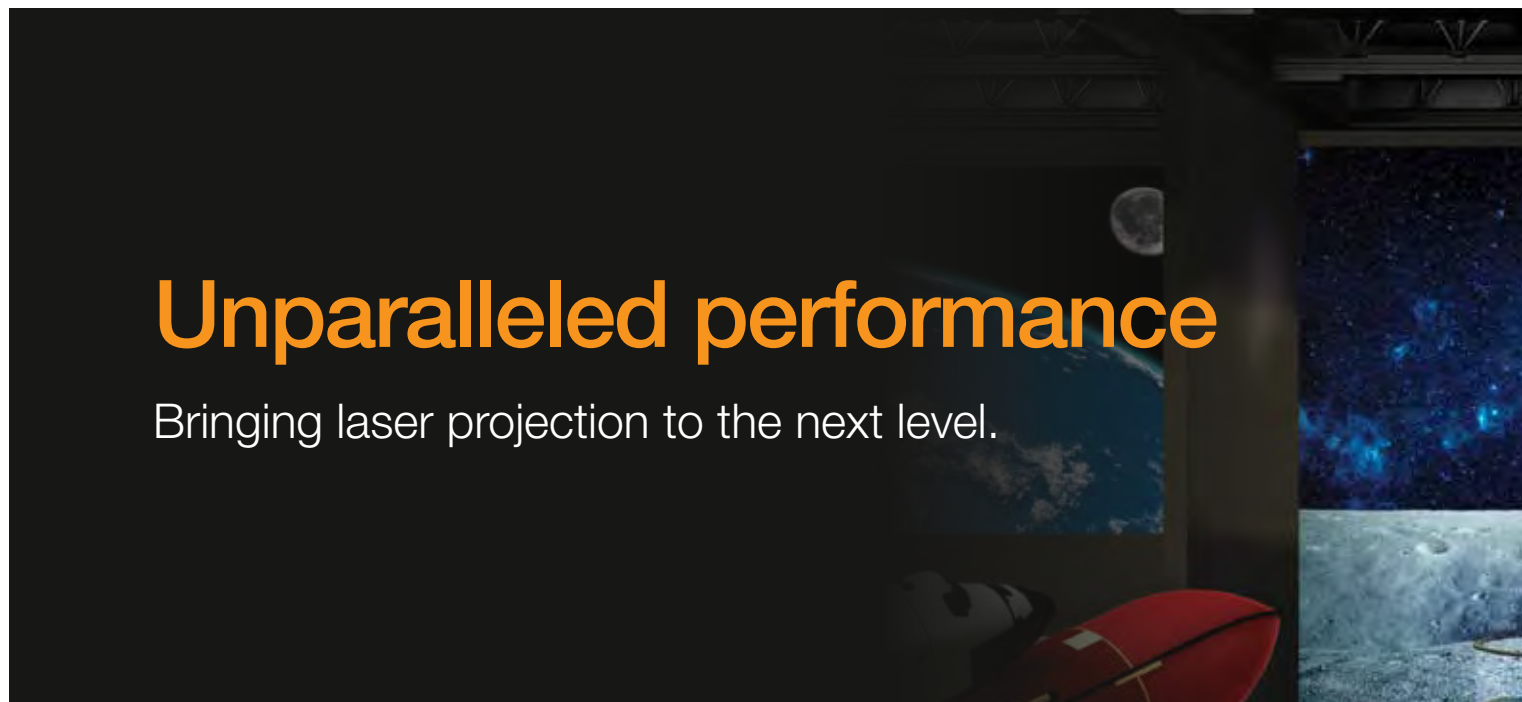

Revolutionary laser light source

Blue light from the laser is projected through a beam splitter, which divides the light into two beams. One beam is reflected by a phosphor wheel, changing it into yellow, while the other beam remains blue. The two beams are then recombined into white light and separated into red, green and blue through dichroic mirrors. Each of the three colours passes through LCD panels, producing three individual images, which are transmitted through a prism and combined into the final full-colour image.

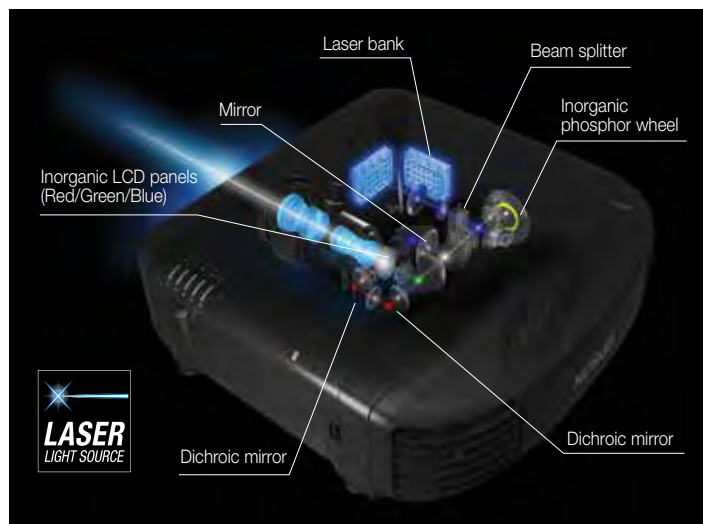

Inorganic LCD panels and phosphor wheel for outstanding reliability

Made of inorganic material, Epson's newly developed phosphor wheel offers superior light and heat resistance to deliver excellent reliability. By combining this with our inorganic LCD panels, we create laser projectors that project bright, vibrant images for extremely long periods.

Organic vs. Inorganic

	Inorganic (Glass, iron, aluminum, etc.)	Organic (Paper, wood, plastic, etc.)
Light-resistance	YES	NO
Heat-resistance	YES	NO

Unlike organic substances, inorganic substances do not contain carbon.

Worry-free projection

With multiple laser diodes to rely on, the screen won't go black even if one diode goes out. This eliminates the worry of the projector light burning out during mission-critical presentations.

Laser



The projector keeps working even when one light diode goes out.

Lamp

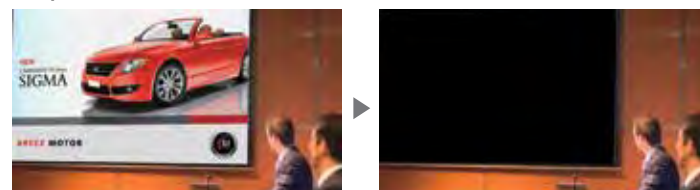

The screen goes black when the lamp burns out.



20,000 hours of maintenance-free use

Engineered with inorganic LCD panels and an inorganic phosphor wheel, this newly designed laser light source delivers 20,000 hours* of maintenance-free use. And with the advanced electrostatic filter having an equally long-lasting life, you enjoy peace of mind in using these highly reliable laser projectors.

* Approximate time until brightness decreases 50% from first usage. Measured by acceleration test assuming use of 0.04 - 0.20 mg/m3 of particulate matter. Time varies depending on usage conditions and environments.

Maintenance period of laser and lamp

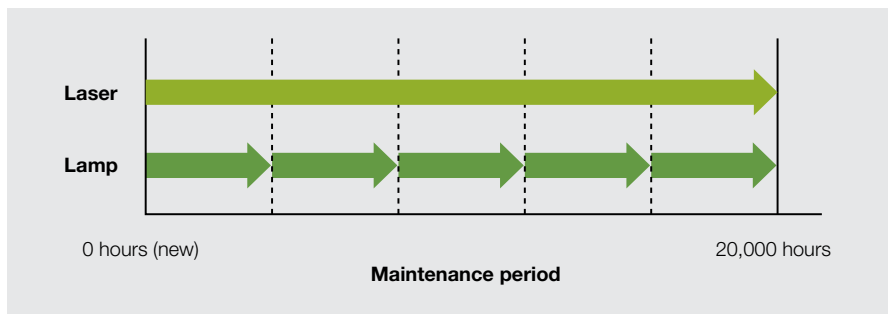

Well-balanced Whites

White light is created through combining the blue and yellow light beams. The advanced optical engine in the EB-L1000 series precisely adjusts the blue and yellow light to create brilliant white highlights, bringing a refreshing vibrancy to your images.



Conventional model



EB-L1000 Series

Fine-tuning Brightness

The EB-L1000 series provides precise brightness adjustment in increments of 1%. This combined with the Constant Brightness mode maintains brightness at a given value to match the venue or subject to deliver astonishing picture quality.

Custom mode with constant brightness

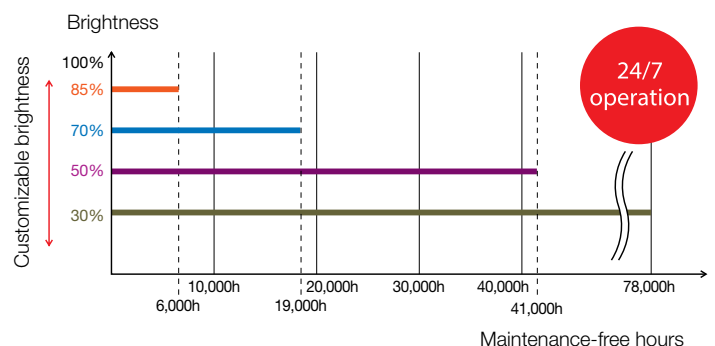

Confident Colours, Greater Details

Stunning, eye-catching images that make your presentations come to life.

WUXGA – Beyond Full HD Resolution

With WUXGA resolution (1,920 x 1,200 pixels), you enjoy a sharp, clear display of Full HD video (1,920 x 1,080 pixels) images down to the smallest details even on large-screen projections for an incredible dynamic viewing experience.

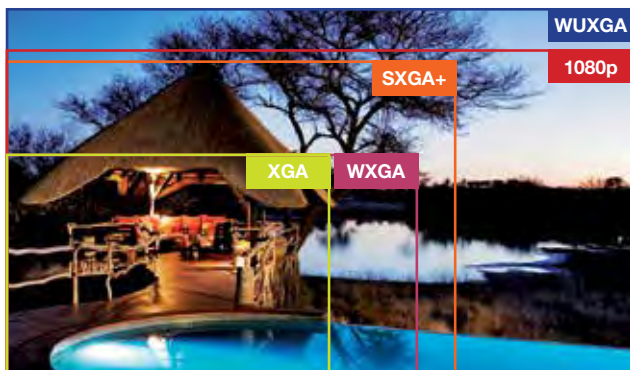

High-definition Images with 4K Enhancement Technology

4K enhancement technology shifts each pixel diagonally by 0.5 pixels to double the resolution to 3840 x 2160, surpassing Full HD image quality to give you unbelievable sharpness, clarity and detail on all your presentations.

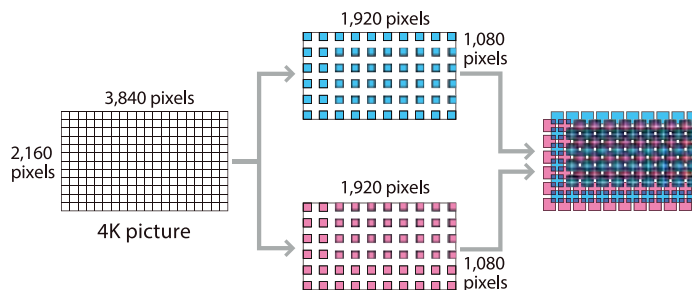

Note: This function can only be used when the input signal is 1080p or higher, and is recommended for projecting HD videos only, not documents.

Super-resolution Technology

Epson's super-resolution technology delivers razor-sharp images even when projecting low-resolution content onto large screens. And with image data processed frame by frame, even rapid motion remains crisp.



Super-resolution off



Super-resolution on

Colour Adjustment

With the colour adjustment function, you can easily adjust the hue, saturation and brightness for each component of RGBCMY to match your preferences.

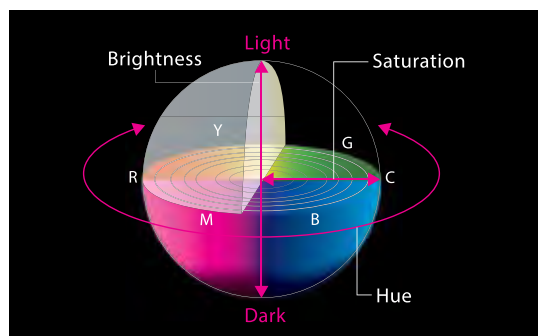

SPECIFICATIONS

EB-L1515SNL/L1715SNL/L1505UHNL/L1755UNL



MODEL NUMBER	EB-L1515SNL	EB-L1715SNL	EB-L1505UHNL	EB-L1755UNL
Projection Technology	RGB liquid crystal shutter projection system (3LCD)			
Specifications of Main Parts				
LCD	Size	1.06" (D10)	1.03" (D10)	
	Native Resolution	SXGA+ (1400 x 1050)	WXGA (1920 x 1200)	
Lightsource	Type	Laser Diode		
	Life (Normal / Extended)	20,000 / 30,000 hours		
Projection Lens (Using Optional ELPPLM15)				
Type	Power Zoom / Power Focus / Power Shift			
F-Number	1.8 - 2.3			
Focal Length	36.00 - 57.35 mm			
Zoom Ratio	1.61			
Throw Ratio	1.62 - 2.65 (Wide to Tele)		1.57 - 2.56 (Wide to Tele)	
Lens Exchange	Yes			
Lens Shift	Mode	Powered		
	Vertical (Up/Down)	±55%	±60%	
Horizontal (Left/Right)	±19%	±18%		
Screen Size (Projected Distance)				
Zoom: Wide	60" - 500" [1.93 - 16.71 m]		60" - 500" [1.99 - 17.17 m]	
Zoom: Tele	60" - 500" [3.18 - 27.10 m]		60" - 500" [3.26 - 27.77 m]	
Brightness¹				
White Light Output (Normal / Extended)	12,000lm / 8,400lm	15,000lm / 10,500lm	12,000lm / 8,400lm	15,000lm / 10,500lm
Colour Light Output	12,000lm	15,000lm	12,000lm	15,000lm
Contrast Ratio	2,500,000:1			
Geometric Correction				
Vertical / Horizontal Keystone	±45° / ±30° (Zoom: Tele) (with Standard Lens)			
Quick Corner	Yes			
Arc	Yes			
Curve Surface	Yes			
Point Correction	Yes			
Corner Wall	Yes			
Geometry Correction Memory	Yes			
Connectivity				
Analog Input	D-Sub 15Pin	1 (Blue)		
	5BNC	1		
Digital Input	DVI-D	1		
	HDMI	1		
	SDI	N/A		
	HDBaseT	RJ45 x 1		
Output Terminal	D-Sub 15Pin	1		
Audio Input	Stereo Mini Jack	3		
Audio Output	Stereo Mini Jack	1		
Others	USB Type A	1 (for Wireless LAN, Firmware Update, Copy OSD Settings)		
	USB Type B	1 (for Firmware Update, Copy OSD Settings)		
Control I/O	RS-232C	D-Sub 9Pin x 1		
	Remote Control Input	Stereo Mini Jack x 1		
Network	Wired LAN	RJ45 x 1		
	Wireless	Optional		
Wireless Specification				
Supported Speed For Each Mode	IEEE 802.11b: 11Mbps ² IEEE 802.11g: 54Mbps ² IEEE 802.11n: 130Mbps ²			
Wireless LAN Security	Quick Mode: OPEN, WPA2-PSK Advanced Mode: OPEN, WPA/WPA2-PSK, WPA/WPA2-EAP Supported EAP Type: PEAP, PEAP-TLS, EAP-TLS, EAP-Fast, LEAP			
Operating Temperature				
Operating Altitude	0 - 50 °C <32 - 122 °F> (Below 1,500m / 4,921ft) 0 - 45 °C <32 - 113 °F> (Above 1,500m / 4,921ft - 3,048m / 10,000ft (with high altitude mode))			
Direct Power On / Off	Yes			
Start-Up Period	Less than 7 seconds, Warm-up Period: 30 seconds			
Cool Down Period	Instant Off			
Air Filter				
Type	High Efficiency Filter			
Maintenance Cycle (Normal / Extended)	20,000 / 30,000 hours ³			
Power Supply Voltage	100 - 240 V AC ±10%, 50/60 Hz			
Power Consumption (220 - 240V)				
Laser Diode (Normal / Extended)	908W / 597W	1024W / 647W	908W / 597W	1024W / 647W
Standby (Network / Energy Saving)	2.0W / 0.3 W			
Dimension Excluding Feet (D X W X H)	492 x 586 x 185 mm			
Weight (Including Standard Lens)	Approx. 23.7 kg	Approx. 24 kg	Approx. 23.7 kg	Approx. 24.1 kg
Weight (Excluding Standard Lens)	Approx. 21.9 kg	Approx. 22.2 kg	Approx. 21.9 kg	Approx. 22.3 kg
Fan Noise (Normal / Quiet)	37dB / 30dB	40dB / 30dB	37dB / 30dB	40dB / 30dB

Supplied Accessories

- Power Cable
- HDMI Cable Clamp
- Remote Control with 2 x AA Battery
- Cable Cover
- User's Manual CDROM

Optional Accessories

- Air Filter: ELPAF51
- Wireless LAN Card: ELPAP10
- HDBaseT Transmitter: ELPHD01
- Remote Control Cable Set: ELPKC28
- Ceiling Mount: ELPMB47 / ELPMB48

Optional Lenses

- Ultra Short Throw Lens: ELPLX02 (NEW)
- Zoom Lens: ELPLU03 / ELPLU04 / ELPLW05 / ELPLW06 / ELPLM10 / ELPLM11 / ELPLM15 (NEW) / ELPLL08

EB-L1515SNL / EB-L1715SNL



EB-L1505UHNL / EB-L1755UNL



©2018 Epson India Pvt. Ltd. All Rights Reserved. Reproduction in part or in whole, without the written permission from Epson, is strictly prohibited.

EPSON and EXCEED YOUR VISION are registered trademarks of Seiko Epson Corporation.

All other product names and other company names used herein are for identification purposes only and are the trademarks or registered trademarks of their respective owners.

Epson disclaims any and all rights in those marks. Projected images shown herein are simulations. The actual product design and contents may vary. Specifications are subject to change without notice and may vary between countries. Please check with local Epson offices for more information.

Apple, iPad and iPhone are trademarks of Apple Inc., registered in the U.S. and other countries. App Store is a service mark of Apple Inc.

Android is a trademark of Google Inc.

Information correct as at January 2018

EPSON INDIA PVT. LTD.

12th Floor, The Millenia, Tower A, No.1,
Murphy Road, Ulsoor, Bangalore - 560 008.
Tel: 080-30515000 Fax: 080-30515005

Regional Offices:

Ahmedabad - 26407176/77, Chennai - 30277500/11, Cochin - 4012315,
Coimbatore - 98942 19200, Kolkata - 65009370/77, Mumbai - 28261515/17,
New Delhi - 46585444, Pune - 30286000, Secunderabad - 40359898

Dealer's Stamp



Epson Helpline:

For product info, service or to order a ribbon cartridge - 1800 425 0011
For service - 1860 3000 1600 (9AM - 6PM) (Mon - Sat)

www.epson.co.in



Auto Colour Calibration with Built-in Camera

The built-in camera detects screens that have become unevenly coloured over time, allowing the projector to automatically correct colour. It also detects subtle colour inconsistencies between multiple projectors. What's more, this function can be programmed to check colour manually or automatically at regular intervals to deliver stable image quality with minimum maintenance.

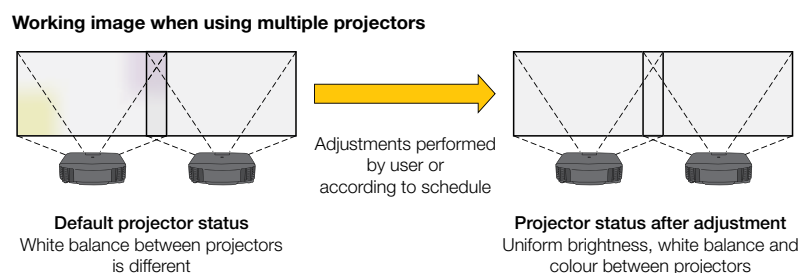
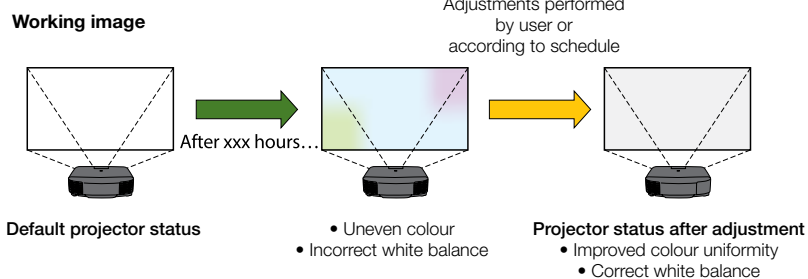
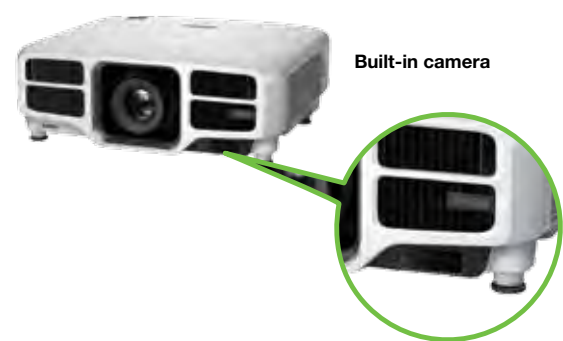

Frame Interpolation

Enjoy clearer, sharper playback even on fast-moving subjects with Epson's Frame Interpolation Technology. This unique function effectively eliminates motion blurring by inserting intermediate frames between images to create smoother motion transition.

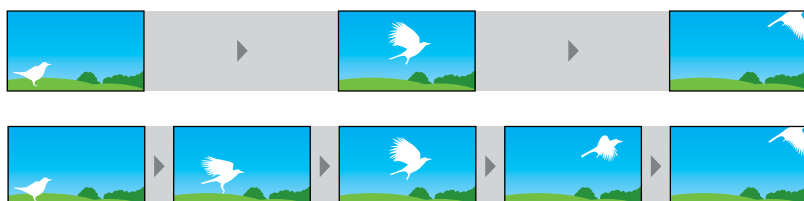

Adaptive Projections

Designed with greater flexibility to fit any venue and application.

Powered Lens with Stepping Motor

The powered lens with stepping motor offers limitless possibilities in projector placement. Covering a wide range of angles, the motorised lens shift gives you a great deal of flexibility when installing the projector. The newly adopted stepping motor lets you make highly precise adjustments when employing edge blending, stacking and other techniques. Adjustments can also be made via remote control or over a network, enhancing usability even for ceiling-mounted projectors.

Lens-position Memory

With storage for up to 10 settings in the projector memory, including shift positions, focus and projection sizes, you can easily and quickly adjust the projector according to the aspect ratio of content simply by using either the remote controller or command control.

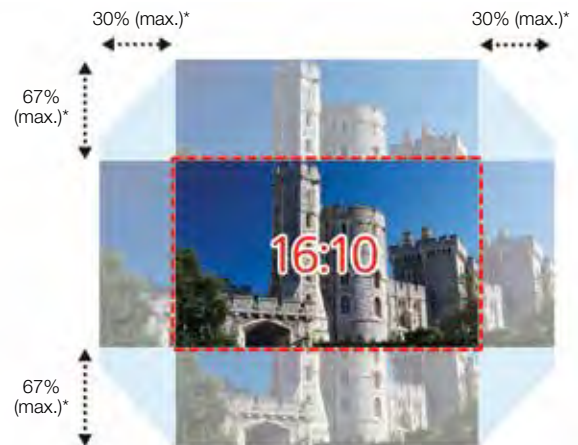

* ±55% vertically, ±19% horizontally for EB-L1515SNL/EB-L1715SNL
±60% vertically, ±18% horizontally for EB-L1505UHNL/EB-L1755UNL

Extensive Lens Options

The Epson EB-L1000 series offers an extensive line-up of optional lenses to fit any venue or subject. And with the ELPLX01 and ELPLX02 zero offset, ultra-short throw lens, you can install the projector even in tight spaces.

LENS	EB-L1100U / L1200U		EB-L1405U		EB-L1755UNL / L1505UHNL		EB-L1715SNL / L1515SNL	
	WUXGA		WUXGA		WUXGA		SXGA +	
	Wide	Tele	Wide	Tele	Wide	Tele	Wide	Tele
ELPLX01	0.35				Not Applicable			
NEW ELPLX02	Not Applicable				0.35		0.36	
ELPLU03	0.65	0.78	0.48	0.57	0.48	0.57	0.49	0.59
ELPLU04	0.87	1.05	0.64	0.77	0.64	0.77	0.66	0.80
ELPLW05	1.04	1.46	0.77	1.07	0.77	1.07	0.79	0.11
ELPLW06	1.62	2.22	1.19	1.62	1.19	1.62	1.23	1.67
ELPLM08	1.44	2.32	1.44	2.32	Not Applicable			
NEW ELPLM15	2.16	3.48	1.57	2.56	1.57	2.56	1.62	2.65
ELPLM10	3.32	5.06	2.42	3.71	2.42	3.71	2.50	3.84
ELPLM11	4.85	7.38	3.54	5.41	3.54	5.41	3.64	5.58
ELPLL08	7.21	10.11	5.27	7.41	5.27	7.41	5.43	7.65



Zero Offset, Ultra-short Throw Lens

A revolutionary invention of Epson, these powerful lens, ELPLX01 and ELPLX02, are especially useful for environments with extremely limited lens-to-screen distances. The short throw ratio of 0.35 with zero-offset and the projector's front-mounted exhaust system means you can project up to 1000-inch screens even from as near as 7.69m away. When combined with lens shift (+45% vertically, ±15% horizontally), these features simplify usage where space is at a premium.

Epson EB-L1000 series

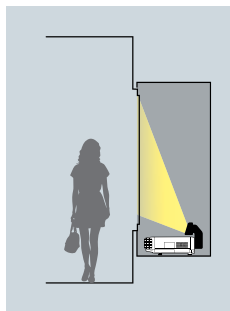

Competitor

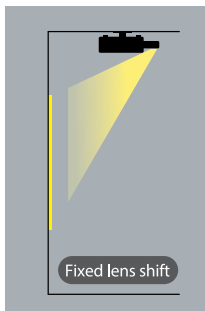

Epson EB-L1000 series

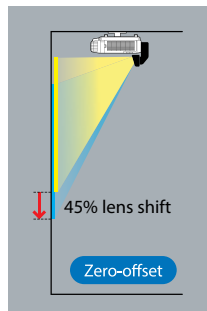

Larger image from shorter distances, plus added installation flexibility

Multi-direction Projection

EB-L1000 series can be rotated 360° in any direction — horizontally, vertically and rotationally — without any loss in image brightness. This makes it ideal for a wide range of applications, such as projecting onto ceilings and floors.

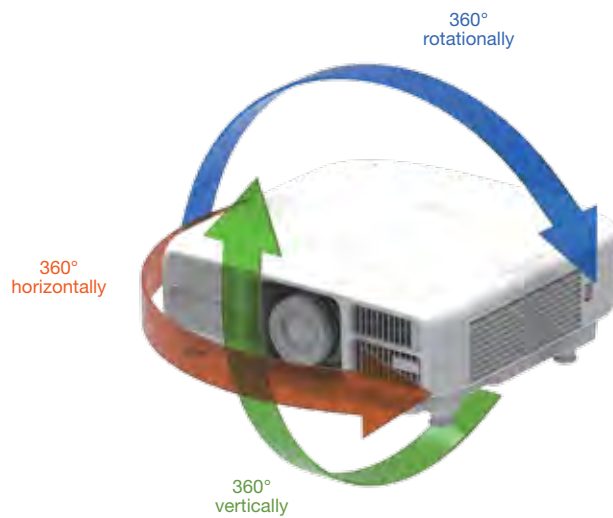

Projection on Wide Curved and Corner Spaces

Fit your projection images nicely even on non-flat surfaces. Create stunning projection images on wide curved surfaces and corner walls, ideal for advertisements and marketing promotions.



HIGH BRIGHTNESS LASER PROJECTORS

EB-L1100U/L1200U/L1405U

EB-L1505UHNL/L1515SNL/L1715SNL/L1755UNL

Borderless Multi Projection

Offering a variety of functions for multi-projector installations, the EB-L1000 series lets you adjust brightness, colour and the position of overlapping areas for seamless, beautiful displays. There is also an Auto Scaling function for easy multi-projector displays and an Advanced Edge Blending function for more precise edge-blending adjustment.



Colour Matching/Brightness Level

Enjoy uniform colour and brightness even when using multiple projectors.

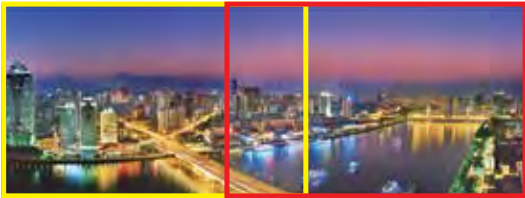

Point Correction

Easily correct single-projector distortion or multi-projector misalignment directly on the screen. Quickly fine-tune the images by adjusting point by point from right to left, top to bottom, using a projected maximum 17 x 17 matrix.



Black Level

Experience uniform black levels in overlapping areas of images even when using multiple projectors.

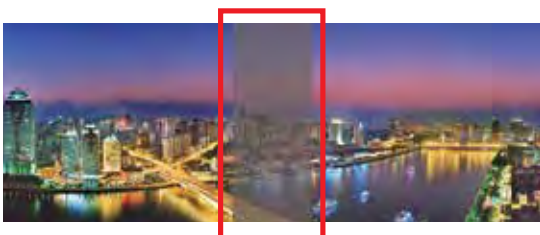

Advanced Edge Blending

Precisely adjust edge blending to combine multiple edges for a seamless, unified look. This function allows you to fine-tune the start position and edge width of the blend as well as the area of the black level in the blend. It also prevents the main subject from being overlapped. As a tip, you can reduce the size of the overlapping areas to decrease the time it takes to combine multiple images.

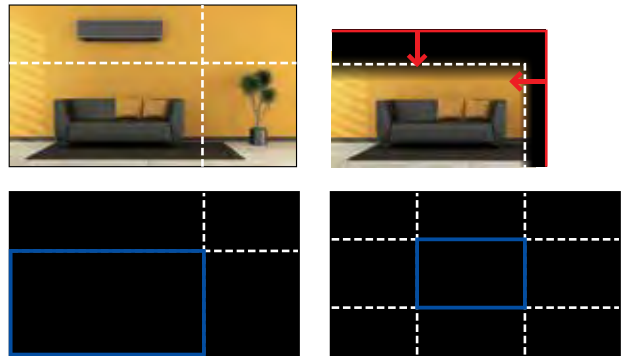

Auto Scaling

This revolutionary function simplifies the complicated scaling of images from multiple projectors so you can do it easily. Just select the screen layout from the pre-set menu and the projector automatically sets the slice area, scaling and edge-blend position.

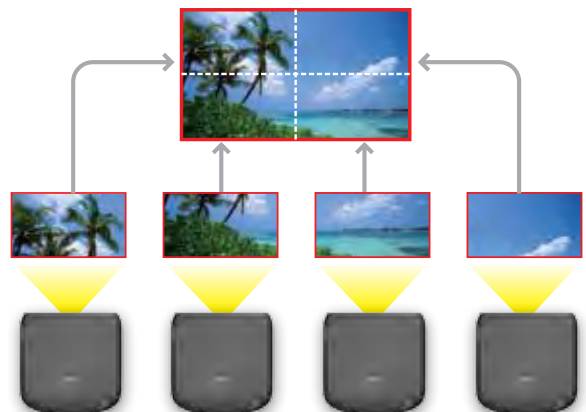

Wide Range of Connectivity

The Epson EB-L1000 series is compatible with a wide range of external devices, and additional ports now include DVI-D, HDMI, HDBaseT and SDI*. Ideal for large venues, HDBaseT can transmit Full HD video, audio and Ethernet at low cost through cat 5e/6 cables up to 100 metres.

* For EB-L1405U/EB-1505UHNL/EB-1755UNL only.



Ease of Maintenance

Epson Projector Management

With Epson's network monitoring and control software, you can see from a single PC which projectors are available and whether they are running efficiently – even across the biggest network. You can configure your projectors and access their serial numbers remotely, as well as receive instant email alerts for pre-defined critical indicators such as non-functioning devices or overheating laser diode.

Now you can send messages or announcements as JPEG files simultaneously to any number of projectors on a network. This makes the EB-L1000 projector series very useful for immediate communication needs or even emergencies.



Web Control

By connecting your projector to a network, you can adjust your projector installation entries from a PC or smart device.



Transfer OSD Information

Reduce installation and setup time when using multiple projectors by transferring OSD settings — such as brightness and colour settings as well as user logos — to multiple machines via USB or over a network.

HIGH BRIGHTNESS LASER PROJECTORS

EB-L1100U/L1200U/L1405U

EB-L1505UHNL/L1515SNL/L1715SNL/L1755UNL

Remote Camera Access

The camera capture function allows administrators to preview errors on-screen remotely in real time simply by linking up to the same network used by the projector. This translates to faster support and minimal projector downtime.



Built-in camera



Temperature Log

The temperature log records unusual temperature fluctuations to provide administrators with information when troubleshooting. Recording is automatically triggered by changes in projector temperature and is measured at 15-minute intervals for up to a total of 24 hours in a group. Each log can hold up to a maximum of 7 groups.



Power Supply Log

Prevent unexpected shutdowns with detailed records of up to 60 voltage logs. This function helps administrator to identify the cause and time of the sudden shutdown due to momentary voltage drop.



Better Products for a Better Future™

For more information on Epson's environmental programmes, visit <http://global.epson.com/SR/environment>.

Eco Features

- Uses just 0.3W of power in standby mode
- Projector optics employ lead-free lenses
- Unpainted plastic housing reduces the environment impact
- The flame retardants used in the plastic housing do not contain chlorine or bromine

PARTNERS IN PERFECTION

Desktop Document Camera ELPDC21



2.6kg/6.6 lbs
1080p output resolution
2 megapixels with 30 fps
12 x optical zoom
HDMI digital connectivity

HDBaseT Transmitter ELPHD01



HDMI Input
RS232C for control
LAN for Ethernet
Allows Full HD uncompressed signal transmission up to 100 meters

ELPLX02



Ultra Short Throw Lens
Throw Ratio: 0.35
Screen Size of up to 1000" Diagonal
Vertical & Horizontal Lens Shift

EPSON REVOLUTIONISES PROJECTOR MARKET WITH 3LCD TECHNOLOGY AND LEADS AS WORLD'S NO.1* PROJECTOR BRAND FOR 16 CONSECUTIVE YEARS!

* Based on independent research by Futuresource Consulting



Inorganic phosphor wheel

The device used to change blue laser light into yellow light. The adoption of an inorganic phosphor wheel has made it durable enough to withstand the high output of a laser light source.

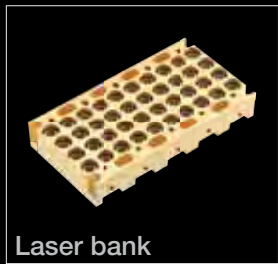

Laser bank

High-powered laser diodes enable to achieve the outstanding brightness-15,000lm.



Inorganic LCD panels (Red/Green/Blue)

Newly developed, large 1.06inch panel. The adoption of an inorganic panel enhances light resistance and helps realise an even longer life.

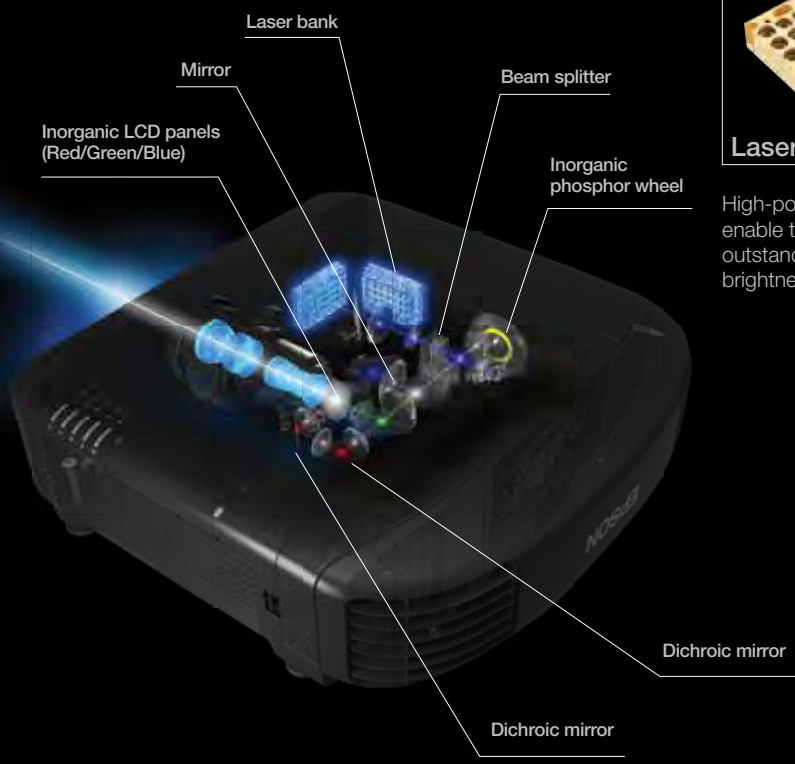

First, blue light from the laser is projected through a beam splitter, which divides the light into two beams: One beam is reflected by a phosphor wheel, where it is changed into yellow, while the other beam remains blue. The two beams are then recombined into white light.

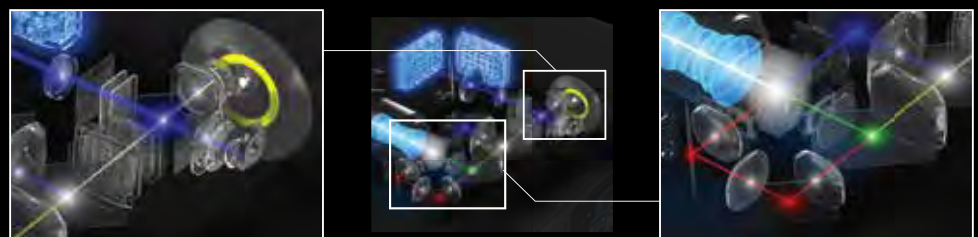

It is separated into red, green and blue through dichroic mirrors. After this, each of the three colours pass through LCD panels, producing three individual images. Lastly, these three images are transmitted through a prism and combined into the final full-colour image.

SEE VIBRANT, REALISTIC COLOURS WITH HIGH COLOUR BRIGHTNESS.



*Leading 1-chip business and education projectors vs. leading Epson 3LCD projectors, selected according to NPD data as of July 2012. Based on 100 responses conducted by NPD Research.

See colours like never before. Epson 3LCD projectors deliver brilliant colours that match its white brightness to give you balanced, realistic, and vibrant images. It's no wonder Epson projectors are the people's preferred choice.



Up to 3X Wider Colour Gamut

Colour gamut refers to the range of colours that can be reproduced by a display device – the wider the gamut, the more realistic it is. Epson 3LCD projectors project three times wider gamut that matches closely to the original standard of a display device (sRGB), as compared to 1-chip projectors.

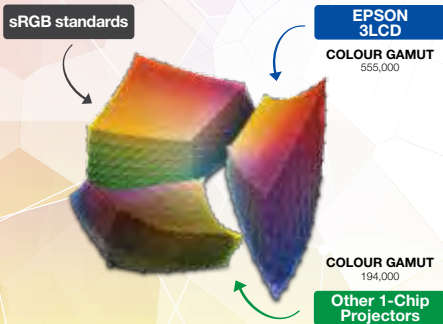

Comparing the yellow corners among the three gamuts, 1-chip projectors have a distinctly darker and smaller set of colours which are not as vibrant as Epson 3LCD projectors.



Up to 3X Brighter Colours

Epson 3LCD projectors deliver up to three times the colour brightness, effortlessly creating the same colour and white brightness, resulting in faithful images with superior colour balance.

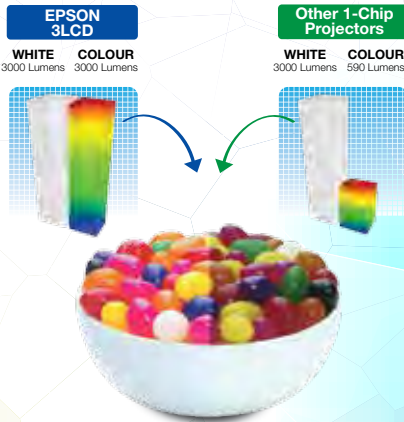

No Rainbow Effect

With 1-chip projectors, the spinning motion of the sequential colour wheels tend to cause colours to break out into distinct red, green and blue. Called the rainbow effect, this may cause users to suffer headaches with prolonged viewing. Epson projectors do not give out this effect, giving users a comfortable experience.



*Compared against similarly-priced leading 1-chip DLP® business and education projectors based on NPD data from July 2011 through June 2012 (available from www.npd.com). Colour brightness (colour light output) measured in accordance with IDMS 15.4. Actual colour brightness will vary depending on actual usage conditions. 3LCD® is a registered trademark of Seiko Epson Corporation. DLP® is a registered trademark of Texas Instruments, Inc. and its use here does not imply any affiliation with or endorsement by them.



LENS SPECIFICATIONS

EB-L1100U/L1200U/L1405U

EB-L1505UHNL/L1515SNL/L1715SNL/L1755UNL



Expanded Lens Suite



Product Image

Model	Ultra Short Throw Lens (ELPLX01)	Ultra Short Throw Lens (ELPLX02)	Zoom Lens (ELPLU03)	Zoom Lens (ELPLU04)	Zoom Lens (ELPLW05)
Product Code	V12H004X01	V12H004X02	V12H004U03	V12H004U04	V12H004W05

Specification of Main Parts

Projection Lens

Type	Powered : Focus / Distortion		Powered : Zoom / Focus / Distortion		
F-Number	1.9		2.0 - 2.3	2.0 - 2.1	
Focal Length	5.8mm	8.0mm	11.1 - 13.1 mm	14.8 - 17.7 mm	
Zoom Ratio	N/A		1 - 1.2		1 - 1.4
Dimension (Diameter of Zoom Ring x Length)	215 x 321 x 164 mm	380 x 340 x 210 mm	150 x 240 mm	150 x 267 mm	
Weight	3500g	5000g	1800g	3100g	
Lens Exchange Correspondence	Yes				

Screen Size	100" - 400" [0.74 - 3.10 m] Throw ratio 0.35	N/A	80" - 300" [1.11 - 4.27 m] (Zoom: Wide) 80" - 300" [1.34 - 5.13 m] (Zoom: Tele) Throw ratio 0.65 - 0.78	50" - 300" [0.91 - 5.76 m] (Zoom: Wide) 50" - 300" [1.11 - 6.93 m] (Zoom: Tele) Throw ratio 0.87 - 1.05	50" - 300" [1.09 - 6.90 m] (Zoom: Wide) 50" - 300" [1.55 - 9.56 m] (Zoom: Tele) Throw ratio 1.04 - 1.46
	Lens Shift Range	Powered Vertical: +50% to +67% (H Center) Horizontal: ±10% (Vertical+50%)	N/A	Powered Vertical: ±67% (H Center) Horizontal: ±30% (V Center)	
Screen Size	100" - 400" [0.74 - 3.10 m] Throw ratio 0.35	N/A	110" - 400" [1.10 - 4.16 m] (Zoom: Wide) 110" - 400" [1.35 - 5.00 m] (Zoom: Tele) Throw ratio 0.48 - 0.57	60" - 500" [0.80 - 7.04 m] (Zoom: Wide) 60" - 500" [0.97 - 8.48 m] (Zoom: Tele) Throw ratio 0.64 - 0.77	70" - 400" [1.11 - 6.74 m] (Zoom: Wide) 70" - 400" [1.59 - 9.34 m] (Zoom: Tele) Throw ratio 0.77 - 1.07
	Lens Shift Range	Powered Vertical: +50% to +67% (H Center) Horizontal: ±10% (Vertical+50%)	N/A	Powered Vertical: ±24% (H Center) Horizontal: ±10% (V Center)	Powered Vertical: ±60% (H Center) Horizontal: ±18% (V Center)
Screen Size	N/A	100" - 1000" [0.72 - 7.69 m] Throw ratio 0.35	80" - 500" [0.80 - 5.21 m] (Zoom: Wide) 80" - 500" [0.97 - 6.26 m] (Zoom: Tele) Throw ratio 0.48 - 0.57	60" - 500" [0.80 - 7.04 m] (Zoom: Wide) 60" - 500" [0.97 - 8.48 m] (Zoom: Tele) Throw ratio 0.64 - 0.77	60" - 500" [0.92 - 8.22 m] (Zoom: Wide) 60" - 500" [1.35 - 11.69 m] (Zoom: Tele) Throw ratio 0.77 - 1.07
	Lens Shift Range	N/A	Powered Vertical: +45% to +70% (H Center) Horizontal: ±15% (Vertical+50%)	Powered Vertical: ±24% (H Center) Horizontal: ±10% (V Center)	Powered Vertical: ±60% (H Center) Horizontal: ±18% (V Center)
Screen Size	N/A	100" - 1000" [0.72 - 7.49 m] Throw ratio 0.36	80" - 500" [0.78 - 5.06 m] (Zoom: Wide) 80" - 500" [0.95 - 6.10 m] (Zoom: Tele) Throw ratio 0.49 - 0.59	60" - 500" [0.78 - 6.81 m] (Zoom: Wide) 60" - 500" [0.95 - 8.24 m] (Zoom: Tele) Throw ratio 0.66 - 0.80	60" - 500" [0.92 - 8.22 m] (Zoom: Wide) 60" - 500" [1.32 - 11.39 m] (Zoom: Tele) Throw ratio 0.79 - 1.11
	Lens Shift Range	N/A	Powered Vertical: +45% to +55% (H Center) Horizontal: ±5% (Vertical+50%)	Powered Vertical: ±16% (H Center) Horizontal: ±9% (V Center)	Powered Vertical: ±55% (H Center) Horizontal: ±19% (V Center)
Operating Temperature	0 - 45 °C		0 - 45 °C		0 - 50 °C
Storage Temperature	-10 - 60 °C				0 - 45 °C
Operating Angle of Tilt	360°				

EB-L1100U / L1200U

EB-L1405U

EB-L1505UHNL / L1755UNL

EB-L1515SNL / L1715SNL

LENS SPECIFICATIONS

EB-L1100U/L1200U/L1405U

EB-L1505UHNL/L1515SNL/L1715SNL/L1755UNL



Product Image

Model	Zoom Lens (ELPLW06)	Ultra Short Throw Lens (ELPLM08)	Zoom Lens (ELPLM10)	Zoom Lens (ELPLM11)	Zoom Lens (ELPLM15)	Zoom Lens (ELPLL08)	
Product Code	V12H004W06	V12H004M08	V12H004M0A	V12H004M0B	V12H004M0F	V12H004L08	
Specification of Main Parts							
Projection Lens Type	Powered : Zoom / Focus						
F-Number	1.8 - 2.3	1.7 - 2.3	1.8 - 2.4		1.8 - 2.35	1.8 - 2.5	
Focal Length	27.3 - 37.0 mm	24.0 - 38.2 mm	55.4 - 83.3 mm	80.6 - 121.1 mm	36.0 - 57.4 mm	119.0 - 165.4 mm	
Zoom Ratio	1 - 1.4	1 - 1.6	1 - 1.5		1 - 1.6	1 - 1.4	
Dimension (Diameter of Zoom Ring x Length)	129.8 x 236 mm	115 x 191 mm	104 x 243 mm	104 x 245 mm	111.2 x 202 mm	104 x 247 mm	
Weight	2950g	1200g	2200g		1900g	2200g	
Lens Exchange Correspondence	Yes						
Screen Size	50" - 300" [1.72 - 10.66 m] (Zoom: Wide) 50" - 300" [2.35 - 14.52 m] (Zoom: Tele) Throw ratio 1.62 - 2.22	50" - 300" [1.53 - 9.43 m] (Zoom: Wide) 50" - 300" [2.48 - 15.10 m] (Zoom: Tele) Throw ratio 1.44 - 2.32	50" - 300" [3.52 - 21.77 m] (Zoom: Wide) 50" - 300" [5.38 - 32.96 m] (Zoom: Tele) Throw ratio 3.32 - 5.06	50" - 300" [5.11 - 31.86 m] (Zoom: Wide) 50" - 300" [7.84 - 48.19 m] (Zoom: Tele) Throw ratio 4.85 - 7.38	50" - 300" [2.29 - 14.11 m] (Zoom: Wide) 50" - 300" [3.72 - 22.69 m] (Zoom: Tele) Throw ratio 2.16 - 3.48	50" - 300" [7.61 - 47.28 m] (Zoom: Wide) 50" - 300" [10.74 - 66.02 m] (Zoom: Tele) Throw ratio 7.21 - 10.11	
Lens Shift Range	Powered Vertical: ±67% (H Center) Horizontal: ±30% (V Center)						
Screen Size	60" - 500" [1.49 - 12.99 m] (Zoom: Wide) 60" - 500" [2.06 - 17.69 m] (Zoom: Tele) Throw ratio 1.19 - 1.62	50" - 300" [1.53 - 9.43 m] (Zoom: Wide) 50" - 300" [2.48 - 15.10 m] (Zoom: Tele) Throw ratio 1.44 - 2.32	60" - 500" [3.06 - 26.50 m] (Zoom: Wide) 60" - 500" [4.73 - 40.36 m] (Zoom: Tele) Throw ratio 2.42 - 3.71	60" - 500" [4.45 - 38.81 m] (Zoom: Wide) 60" - 500" [6.86 - 58.92 m] (Zoom: Tele) Throw ratio 3.54 - 5.41	60" - 500" [1.99 - 17.17 m] (Zoom: Wide) 60" - 500" [3.26 - 27.77 m] (Zoom: Tele) Throw ratio 1.57 - 2.56	60" - 500" [6.64 - 57.65 m] (Zoom: Wide) 60" - 500" [9.41 - 80.71 m] (Zoom: Tele) Throw ratio 5.27 - 7.41	
Lens Shift Range	Powered Vertical: ±60% (H Center) Horizontal: ±18% (V Center)						
Screen Size	60" - 500" [1.49 - 12.99 m] (Zoom: Wide) 60" - 500" [2.06 - 17.69 m] (Zoom: Tele) Throw ratio 1.19 - 1.62	N/A	60" - 500" [3.06 - 26.50 m] (Zoom: Wide) 60" - 500" [4.73 - 40.36 m] (Zoom: Tele) Throw ratio 2.42 - 3.71	60" - 500" [4.45 - 38.81 m] (Zoom: Wide) 60" - 500" [6.86 - 58.92 m] (Zoom: Tele) Throw ratio 3.54 - 5.41	60" - 500" [1.99 - 17.17 m] (Zoom: Wide) 60" - 500" [3.26 - 27.77 m] (Zoom: Tele) Throw ratio 1.57 - 2.56	60" - 500" [6.64 - 57.65 m] (Zoom: Wide) 60" - 500" [9.41 - 80.71 m] (Zoom: Tele) Throw ratio 5.27 - 7.41	
Lens Shift Range	Powered Vertical: ±60% (H Center) Horizontal: ±18% (V Center)						
Screen Size	60" - 500" [1.45 - 12.68 m] (Zoom: Wide) 60" - 500" [2.00 - 17.22 m] (Zoom: Tele) Throw ratio 1.23 - 1.67	N/A	60" - 500" [2.98 - 25.78 m] (Zoom: Wide) 60" - 500" [4.61 - 39.38 m] (Zoom: Tele) Throw ratio 2.50 - 3.84	60" - 500" [4.31 - 37.71 m] (Zoom: Wide) 60" - 500" [6.68 - 57.42 m] (Zoom: Tele) Throw ratio 3.64 - 5.58	60" - 500" [1.93 - 16.71 m] (Zoom: Wide) 60" - 500" [3.18 - 27.10 m] (Zoom: Tele) Throw ratio 1.62 - 2.65	60" - 500" [6.45 - 56.12 m] (Zoom: Wide) 60" - 500" [9.16 - 78.65 m] (Zoom: Tele) Throw ratio 5.43 - 7.65	
Lens Shift Range	Powered Vertical: ±55% (H Center) Horizontal: ±19% (V Center)						
Operating Temperature	0 - 50 °C						
Storage Temperature	-10 - 60 °C						
Operating Angle of Tilt	360°						

EB-L1100U / L1200U

EB-L1405U

EB-L1505UHNL / L1755UNL

EB-L1515SNL / L1715SNL

CAD DRAWING

Top View

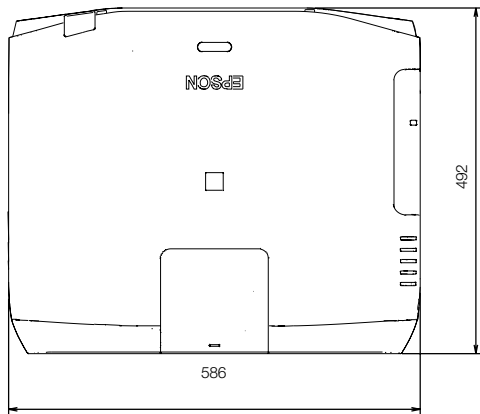

Bottom View

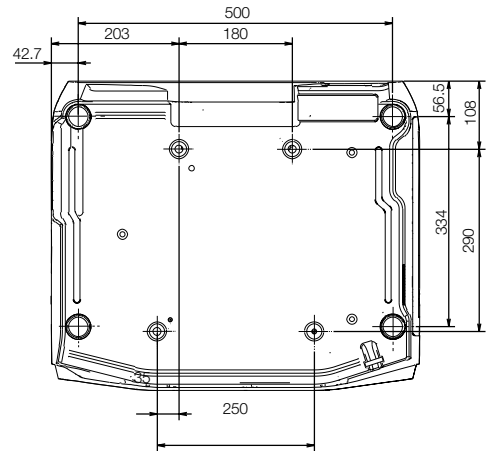

Front View

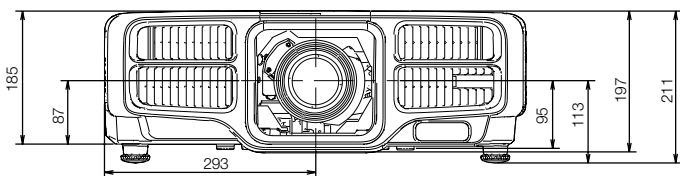

Side View

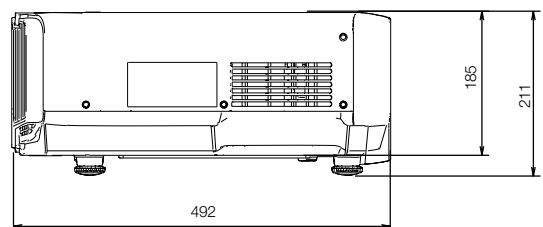

SPECIFICATIONS

EB-L1100U/L1200U/L1405U



MODEL NUMBER	EB-L1100U	EB-L1200U	EB-L1405U	
Projection Technology	RGB liquid crystal shutter projection system (3LCD)			
Specifications of Main Parts				
LCD	Size	0.76" (D10)		
	Native Resolution	WUXGA (1920 x 1200)		
Projection Lens	Type	Power Zoom / Power Focus / Power Shift		
	F-Number	1.7 - 2.3		
	Focal Length	24.02 - 38.24 mm		
	Zoom Ratio	1 - 1.6		
	Throw Ratio	1.45 - 2.32 (Wide to Tele)		
	Lens Exchange	Yes		
	Lens Shift	Mode	Powered	
		Vertical (Up/Down)	±67%	
		Horizontal (Left/Right)	±30%	
	Lightsource	Type	Laser Diode	
Life (Normal / Long)		20,000 / 30,000 hours		
Screen Size (Projected Distance)				
Zoom: Wide	50" - 300" [1.53 - 9.44 m]			
Zoom: Tele	50" - 300" [2.48 - 15.10 m]			
Brightness¹				
White Light Output (Normal / Eco)	6,000lm / 4,200lm	7,000lm / 4,900lm	8,000lm / 5,600lm	
Colour Light Output	6,000lm	7,000lm	8,000lm	
Contrast Ratio	2,500,000:1			
Internal Speaker(s)				
Sound Output	10W x 1	N/A		
Geometric Correction				
Vertical / Horizontal Keystone	±45° / ±30° (Zoom: Tele) (with Standard Lens)			
Quick Corner	Yes			
Curve Surface	Yes			
Point Correction	Yes			
Corner Wall	Yes			
Connectivity				
Analog Input	D-Sub 15Pin	1 (Blue)		
	5BNC	1		
Digital Input	DVI-D	1		
	HDMI	1 (with HDCP 2.2)		
	HDBaseT (FX)	RJ45 x 1 (with HDCP 2.2)	RJ45 x 1 (with HDCP2.2 and Art-Net Support)	
	BNC (SDI)	N/A	1x	
Output Terminal	D-Sub 15Pin	1		
Audio Input	Stereo Mini Jack	3		
Audio Output	Stereo Mini Jack	1		
Others	USB Type A	1 (for Wireless LAN, Firmware Update, Copy OSD Settings)		
	USB Type B	1 (for Firmware Update, Copy OSD Settings)		
Control I/O	RS-232C	D-Sub 9Pin x 1		
	Remote Control Input	Stereo Mini Jack x 1		
Network	Wired LAN	RJ45 x 1 (100Mbps)	RJ45 x 1 (100Mbps with Art-Net Support)	
	Wireless	Optional		
Wireless Specification				
Supported Speed For Each Mode	IEEE 802.11b: 11Mbps ² IEEE 802.11g: 54Mbps ² IEEE 802.11n: 130Mbps ²			
Wireless Security	WPA-PSK / WPA2-PSK(TKIP/AES) WPA2-PSK(AES)			
Operating Temperature				
	0 - 45 °C <32 - 113 °F> (Below 1,500m / 4,921ft) 0 - 40 °C <32 - 104 °F> [Above 1,500m / 4,921ft - 3,048m / 10,000ft (with high altitude mode)]			
Operating Altitude				
	0 - 3,048 m <0 - 10,000 ft> (over 1,500m / 4,921ft : with high altitude mode)			
Direct Power On / Off				
	Yes			
Start-Up Period				
	Less than 7 seconds, Warm-up Period: 30 seconds			
Cool Down Period				
	Instant Off			
Air Filter	Type	High Efficiency Filter		
	Maintenance Cycle	20,000 hours ³		
Power Supply Voltage				
	100 - 240 V AC ±10%, 50/60 Hz			
Power Consumption (220 - 240V)				
Laser Diode (Normal / Eco)	454W / 313W	566W / 384W	625W / 417W	
Standby (Network On / Off)	2.4W / 0.28W			
Dimension Excluding Feet (D X W X H)				
	492 x 586 x 185 mm			
Weight (Including Standard Lens)				
	Approx. 20.1kg	Approx. 20.6kg	Approx. 20.6kg	
Weight (Excluding Standard Lens)				
	Approx. 19.0kg	Approx. 19.4kg	Approx. 19.5kg	
Fan Noise (Normal / Eco)				
	34dB / 28dB			

Supplied Accessories

Power Cable
Power Cable Clamp (EB-L1405U)
Computer Cable (VGA Cable)
Remote Control with 2 x AA Battery
Cable Cover
User's Manual CDROM

Optional Accessories

Air Filter: ELPAF51
Wireless LAN Card: ELPAP10
Quick Wireless Connection USB Key: ELPAP09
HDBaseT Transmitter: ELPHD01
Remote Control Cable Set: ELPKC28
Ceiling Mount: ELPMB47 / ELPMB48

Optional Lenses

Ultra Short Throw Lens: ELPLX01
Zoom Lens: ELPLU03 / ELPLU04 / ELPLW05 / ELPLW06 / ELPLM08 / ELPLM10 / ELPLM11 / ELPLM15 (NEW) / ELPLL08

EB-L1100U / EB-L1200U



EB-L1405U



©2018 Epson India Pvt. Ltd. All Rights Reserved. Reproduction in part or in whole, without the written permission from Epson, is strictly prohibited.

EPSON and EXCEED YOUR VISION are registered trademarks of Seiko Epson Corporation.

All other product names and other company names used herein are for identification purposes only and are the trademarks or registered trademarks of their respective owners.

Epson disclaims any and all rights in those marks. Projected images shown herein are simulations. The actual product design and contents may vary. Specifications are subject to change without notice and may vary between countries. Please check with local Epson offices for more information.

Apple, iPad and iPhone are trademarks of Apple Inc., registered in the U.S. and other countries. App Store is a service mark of Apple Inc.

Android is a trademark of Google Inc.

Information correct as at January 2018

¹ Colour brightness (colour light output) and white brightness (white light output) will vary depending on usage conditions. Colour light output measured in accordance with IDMS 15:4; white light output measured in accordance with ISO 21118.

² Maximum speed and range is achievable when used with same enhanced mode technology. Actual data rates, features and performance may vary depending on your computer system, the environment and other factors.

³ When used in the general office environment (the amount of floating dust: 0.04 - 0.2 mg/m³). Based on the Epson's in-house test results.

EPSON INDIA PVT. LTD.

12th Floor, The Millenia, Tower A, No.1,
Murphy Road, Ulsoor, Bangalore - 560 008.
Tel: 080-30515000 Fax: 080-30515005

Regional Offices:

Ahmedabad - 26407176/77, Chennai - 30277500/11, Cochin - 4012315,
Coimbatore - 98942 19200, Kolkata - 65009370/77, Mumbai - 28261515/17,
New Delhi - 46585444, Pune - 30286000, Secunderabad - 40359898

Epson Helpline:

For product info, service or to order a ribbon cartridge - 1800 425 0011
For service - 1860 3000 1600 (9AM - 6PM) (Mon - Sat)

www.epson.co.in

