

# 組合說明

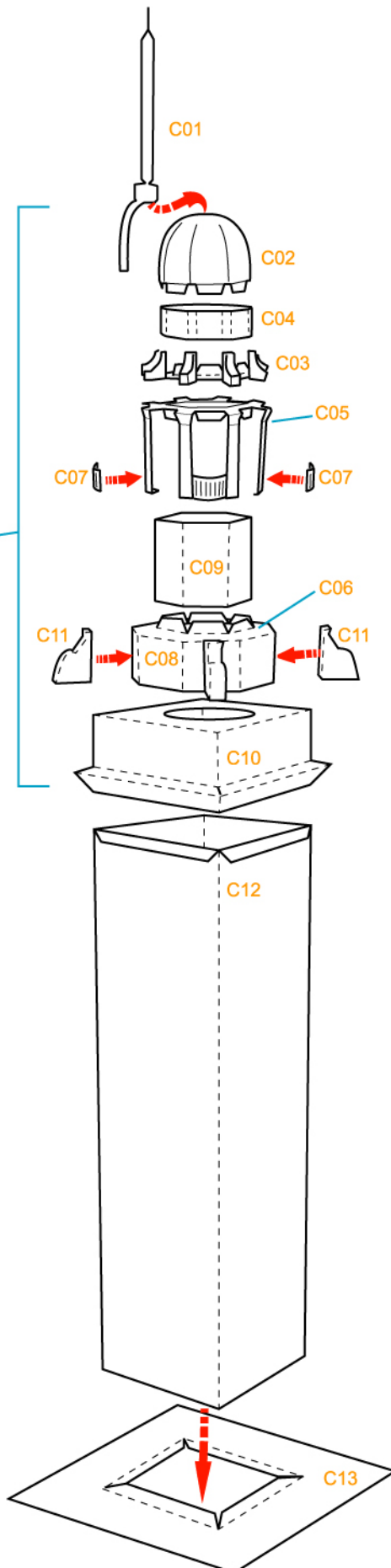

基本步驟

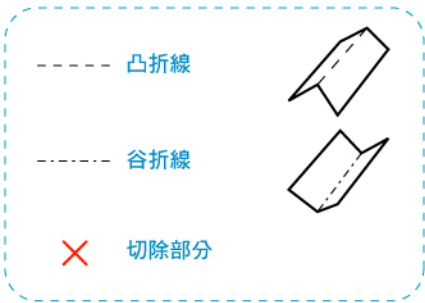
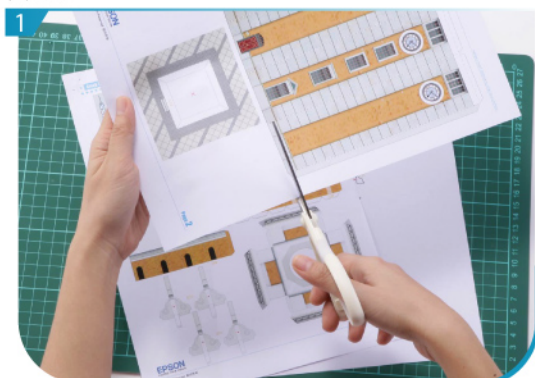

1 沿線剪出所有組件。為免混淆，可先在組件背面劃上記號。



2 剪掉畫有x部份。



3 用沒有墨水的原子筆或鐵筆劃一下摺線。



4 按摺線摺疊。

製作步驟



5 將C01沿線對摺，再沿線剪出準確外形。



6 分別將C04、C08、C09、C10及C12摺疊貼好，形成不同的柱體。



7 將C11摺疊貼好，做成4個相同的立體組件。

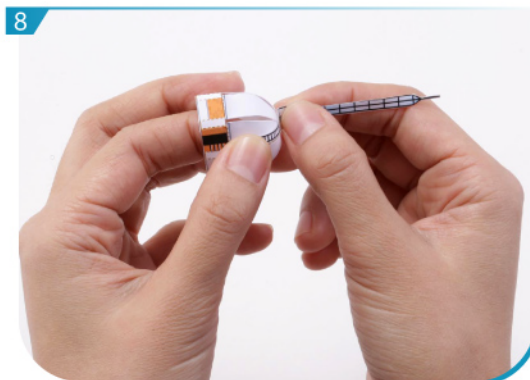

8 將C02及C04黏合，然後貼上C01。



9 小心對準位置，把C03及C04黏合。

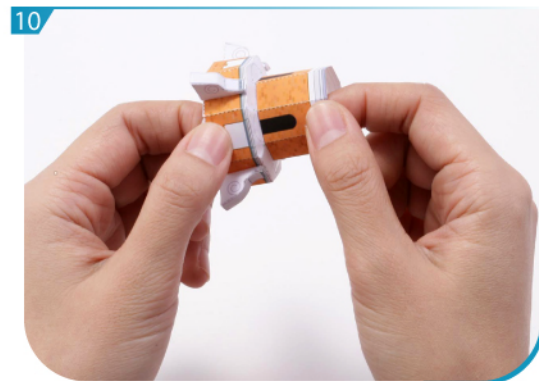

10 先將C06及C08黏合，再對準紅點把C08和C11黏合，然後貼上C09。



11 將C07貼於C05的柱與柱之間，做成圍欄。



12 將C05及C06的綠點對準黏合。

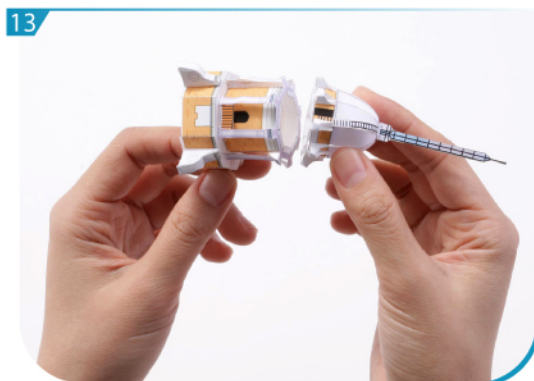

13 將各樓層黏合。

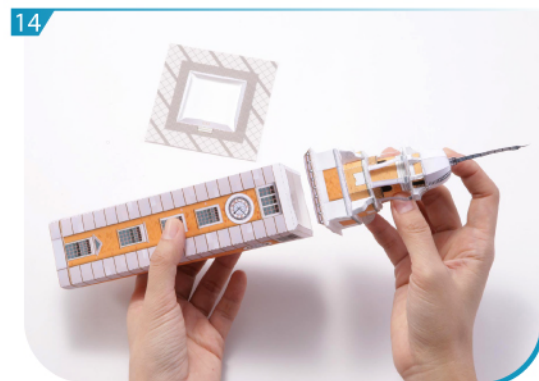

14 最後貼上C12及C13，尖沙咀鐘樓即時重現。