



# EPSON

BE COOL AND SAVE THE WORLD



2023  
PRODUCT  
CATALOGUE

# TABLE OF CONTENT

- 03** INTRODUCTION
- 06** OUR SERVICES
- 14** OUR PARTNER
- 28** INKTANK PRINTER
- 39** PORTABLE PRINTER
- 48** INK CONSUMABLE
- 50** BUSINESS INKJET PRINTER
- 70** COMMERCIAL & INDUSTRIAL PRINTER
- 94** LASER PRINTER
- 100** BUSINESS & PHOTO SCANNER
- 116** 3LCD PROJECTOR
- 144** TM PRINTER
- 154** LABEL INKJET PRINTER
- 162** LABEL PRINTER
- 170** DISC PUBLISHER
- 174** DOT MATRIX PRINTER
- 186** ROBOT SOLUTION



# EPSON INNOVATES TO EXCEED

**Halo, Apa kabar ?**

Salam Hangat dari Saya, **Ng Ngee Khiang** selaku **Direktur PT Epson Indonesia**. Dalam kesempatan ini, ijin kan saya untuk menyapa Anda semua, saya berharap Anda selalu dalam keadaan sehat, aman dan tetap produktif.

Bertepatan dengan Ulang Tahun Epson Indonesia ke 22, Saya mengucapkan Terima kasih atas kerjasama dan kepercayaannya selama ini kepada seluruh mitra dan pelanggan Epson di Indonesia atas dukungan kepada Epson Indonesia selama 22 tahun berada di Indonesia. Selama perjalanan 22 tahun ini, Epson Indonesia selalu berusaha untuk memberikan kualitas terbaik di setiap produk dan solusi yang diberikan. Hal ini tidak terlepas dari semangat, kolaborasi serta dukungan yang luar biasa dari Anda semua.

Dedikasi dan kerja keras para mitra dan pelanggan Epson Indonesia memiliki peran penting pada perkembangan Epson Indonesia hingga sekarang ini. Semoga dengan bertambahnya usia Epson Indonesia saat ini, tetap selalu menjadi yang terdepan dalam setiap inovasi produk yang diberikan.

Akhir kata, saya ingin mengajak semua masyarakat Indonesia untuk terus mendukung setiap langkah dari Epson Indonesia. Semoga Perusahaan ini dapat memberikan lebih banyak manfaat untuk masyarakat kedepannya secara berkelanjutan.

***Stay safe, stay healthy, and stay productive.***

Terima kasih!

**Ng Ngee Khiang**  
**Managing Director**  
**of Epson Indonesia**



# EPSON INDONESIA COVERAGE AREA



**15** EPSON SALES & SERVICES

**13** EPSON SERVICE CENTER

**219** EPSON AUTHORIZED SERVICE PARTNER



**10** EPSON  
NATION-WIDE  
DISTRIBUTOR

**135** EPSON  
AUTHORISED  
MASTER DEALER

**804** EPSON  
AUTHORISED  
DEALER

# EPSON SALES & SERVICE

City	Name	Address
Bandung	ESS Bandung	Jl. Cihampelas No. 48 A Bandung Jawa Barat 40116
Bogor	ESS Bogor	Jl. Raya Pajajaran Ruko No.15B Bantarjati, Bogor - Jawa Barat 16153
Cikarang	ESS Cikarang	Ruko Metro Boulevard B1 Jababeka cikarang - Jawa Barat 17530
Denpasar	ESS Denpasar	Jl. Mahendradata No. 18B, Padangsambian, Denpasar - Bali 80117
Jakarta	ESS Jakarta (Cilandak)	CIBIS Business Park Tower 9 Lot 304, Jalan TB Simatupang No.2, Jakarta Selatan - DKI Jakarta 12560
Jakarta	ESS Jakarta (Mangga Dua)	Ruko Mall Mangga Dua No. 48 Jl. Arteri Mangga Dua, Jakarta Pusat - DKI Jakarta 14420
Jakarta	ESS Jakarta (Sudirman)	Wisma Keiai Lt. 1 Jl. Jenderal Sudirman Kav. 3 Jakarta Pusat - DKI Jakarta 10220
Makassar	ESS Makassar	Jl. Cendrawasih No. 3A, Kunjung Mae, Mariso, Makassar - Sulsel 90125
Manado	ESS Manado	Kawasan Megamas, Jl. Piere Tendean Blok D No.4 Manado Sulawesi Utara 95111
Palu	ESS Palu	Jl. Juanda No.58 - Palu 94111
Purwokerto	ESS Purwokerto	Jl. Jendral Sudirman Ruko PJKA No.4, Kranji, Purwokerto - Jawa Tengah 53116
Semarang	ESS Semarang	Komplek Ruko Metro Plaza Blok C20 Jl. Mt Haryono No. 970 Semarang -Jawa Tengah 50242
Surabaya	ESS Surabaya Gubeng	Jl. Raya Gubeng No. 62, Surabaya - Jatim
Surabaya Barat	ESS Surabaya Barat	Jl. H.Abdul Wahab Saimin, Ruko Villa Bukit Mas Rm-11 Rt.01 Rw.07 Kel. Dukuh Pakis Kec. Dukuh Pakis, Surabaya - 60225
Tangerang	ESS Tangerang	Ruko Melati Mas Square Blok A2 No.17 Serpong Tangerang Selatan Banten 15310

# EPSON SERVICE CENTER

City	Name	Address
Ambon	ESC Ambon	Jl. Diponegoro No.37 (Samping Bank Syariah Indonesia) Kel. Alhusen, Kec.Sirimau - Ambon 97127
Banjarmasin	ESC Banjarmasin	Jl. Gatot Soebroto No. 153 Banjarmasin - Kalsel 70235
Batam	ESC Batam	Jl. Komplek Bumi Indah blok V No. 14, Kel. Lubuk Baja Kota, Kec. Lubuk Baja, Kota Batam, Kepri 29444
Cirebon	ESC Cirebon	Jl. Tuparev No. 04 ( Depan Hotel Apita ) Cirebon, Jawa Barat 45153 <b>[Moved on August 2023 to Jl. Pemuda Raya No.36E, Sunyaragi, Kec. Kesambi, Kota Cirebon, Jawa Barat 45132]</b>
Jember	ESC Jember	Jl. Panglima Besar Sudirman Ruko No.1D Jember-Jawa Timur (Depan Balai Penelitian & Pengolahan Kakao) 68118
Madiun	ESC Madiun	Jl. Diponegoro No.56A, Kec Kartoharjo, Madiun - Jawa Timur 63119
Medan	ESC Medan	Jl. Bambu II Komplek Graha Niaga Nomor A3B/A4, Medan - Sumut 20235
Palembang	ESC Palembang	Jl. H.M Rasyid Nawawi No. 249 Kelurahan 9 Ilir Palembang Sumatra Selatan 30113
Pekanbaru	ESC Pekanbaru	Jl. Tuanku Tambusai No. 459 A Kel. Tangkerang Barat Kec Marpoyan Damai Pekanbaru, Riau 28282
Pontianak	ESC Pontianak	Komplek Centra Bisnis Ayani Mega Mall Blok G.33, Jl. Ahmad Yani - Pontianak, Kalimantan Barat 78113
Samarinda	ESC Samarinda	Jl. Kh. Wahid Hasyim (M. Yamin) Kel. Sempaja Selatan, Kec. Samarinda Utara - Samarinda, Kaltim 75119
Serang	ESC Serang	Jl. Ahmad Yani No.45C, Serang - Banten 42117
Yogyakarta	ESC Yogyakarta	Yap Square, Blok A No. 6 Jl. C Simanjutak No. 2, Yogyakarta - DIY 55233

# EPSON CUSTOMER CARE.

Feel free to contact us

 1-500-766

Chat (Whatsapp, SMS)  
**0812-12-37766**  
EPSON

OUR SERVICES



**JAM OPERASIONAL EPSON CUSTOMER CARE DI  
SENIN – SABTU , 07:00 – 19:00 WIB**

[customer.care@ein.epson.co.id](mailto:customer.care@ein.epson.co.id)

 @EpsonIndonesia  Epson Indonesia  Epson Indonesia  @EpsonIndonesia  Epson Indonesia  [www.epson.co.id](http://www.epson.co.id)

# EPSON AUTHORISED SERVICE PARTNER

City	Name	Address	Phone
Abepera	Dunia Computer	Jl. Raya Abepera, Samping Pengadilan Negri Abepera - Papua 99351	0967-5185007
Ambon	HI-Tech Computer	Jl. Imam Bonjol No. 12, Ambon - Maluku 97124	0911-343434
Balikpapan	Widya Wisesa	Komp. Pantai Mas Permai Blok B No.14, Jl. Jend. Sudirman, Balikpapan-Kaltim 76100	62 542 730439
Banda Aceh	Angkasa Putera Abadi	Jl. T. Panglima Polem no. 141 Banda Aceh 23122-NAD	0651-636026
Banda Aceh	CV. Dunia Komputer	Jl. Mr. Mohd. Hasan, Suka Damai No. 3 - Banda Aceh 23127	0651-637300
Bandar Lampung	CV. Rai Inkpart Computer	Jl. Diponegoro No. 121F, Sumur Batu - Teluk Betung - Lampung 35214	0813 69025565
	Mahirnet Servisindo	Jl. Kartini No. 134, Tanjung Karang, Bandar-Lampung. Lampung 35116	62 721 250456; 62 721 250486
Bandung	MIP Bandung	Ruko ITC Kosambi Blok D1, Jl. Baranangsiang Kel. Kebo Pisang Kec. Sumur Bandung, Kota Bandung - 40112	022 - 20536911
	Mega Computer	Bec Lt. 2 Blok C3-06, Jl. Purnawarman No. 13-15 Bandung 40117	022-4236660 / 02220510524
	CN Computer	Jl. Taman Kopo Indah 2 Ruko 1A No. 37 Bandung - Jawa Barat 40262	022-5427034 / 02254413777
	Yasa Computer	Bandung Trade Mall Jl. Ibrahim Adjie No. 47 Lt. 2 Blok Bb-42 40272	022-7215510
	Wahana Jaya	Jl. A. Yani No. 238 Lt. 1 Blok G 9-10 Komp. Jaya Plaza Bandung 40271	022-7202728
	PT. Teknika Sarana Gardian (Bandung)	Jl. Semar No.1 Kelurahan Arjuna, Kec Cicendo, Kota Bandung, Jawa Barat 40172	022-20597937
Banjarnegara	BM Computer	Jl. Kapten Jambur No.03 RT.04 RW.02 Kota Banjarnegara Jawa Barat 46321	0265-744565 / 085103022050
Banjarbaru	CV. Twincom	Jl. Panglima Batur Timur Rt02 No.06 (Deretan Rs. Mawar) Banjarbaru 70711	08115138800
Banjarmasin	Berlin Komputer	Jl. Kol Sugiono No.19, Banjarmasin. Kalimantan-Selatan 70233	62 511 3260228; 62 511 410750
	CV. Multi Prima	Jl. Veteran No. 8-9 Rt 07/01 Kel. Kuripan Banjarmasin - Kalsel 70236	0511-3277154
Barabai	CV Hidayah Technology	Jl. Ulama RT. 6 No. 23 Barabai Kab. Hulu Sungai Tengah, Kalimantan Selatan 71314	0517-41051
Batam	Muracom	Ruko Rafflesia Blok C No. 6 Batam Centre - Batam Kepri 29461	0778-472518/ 0778-472515/ 0778-7320615
Batulicin	CV Smart Jaya Tech	Jl. Pesantren No. 71 Batulicin, Tanah Bumbu, Kalimantan Selatan 72171	081349559909
Baturaja	CV. Jasu sri Wahyu (Digicom)	Jl. Jend Ahmad Yani No.14B, Air Karang, Desa Tanjung Baru, Baturaja, Ogan Komering Ulu, Sumatera Selatan 32121	0735-326634
Bekasi	XYZ-Go Print	Ruko Suncity Squire Blok A-21 Jl.Mayor Madmuin Hasibuan Margajaya Bekasi Selatan Kota Bekasi 17141	081398362722
	PT. HSN Tech Indonesia (Bekasi)	Komplek Ruko Bekasi Mas Blok C No.15 Jl. Jendral Ahmad Yani Bekasi Selatan 17141	021-500155
Bengkayang	CV. Harindo	Jl. Sanggau Ledo No. 24 Rt.04/Rw.02 Sebopet, Bengkayang - Kalbar 79284	0562-4442340
Bengkulu	CV. Biru Teknologi Multimedia	Jl. Mt Haryono No 19B Kampung Bali - Bengkulu 38114	0736-28548
Bima	Sentral Muslim	Jl. Soekarno Hatta, No.77, Kota Bima, Ntb 84111	0374-646806
Binjai	Zip Computer	Jl. Jend. A. Yani No. 8F, Komp. Gvr, Kel. Kartini, Binjai - Sumut 20711	061-8825722
Bireuen	CV. Putra Solusindo Computer	Jl Medan B Aceh No 15 Bireuen - Aceh 24211	0644-22709
Bitung	Smart Computer	Jl. H. V. Worang No.2, Kel.Kadoodan Kec. Madidir, Bitung - Sulut 95513	0438-30805
Blangkejeren	CV. Mulia	Jl. Pasar Lama No. 156 Kota Blankejeren Kec Blankejeren Kab Gayo Luwes Aceh 24655	081286132992
Bogor	PT. Gerai Servis Indonesia	Ruko Taman Yasmin Sektor VI No. 138 Jl. KHR abd. Bin M Nuh Bogor 16113	0251-7592054
Bojonegoro	Hitech Bojonegoro	Jl. Teuku Umar No 52 Bojonegoro 62111	085231167031
Bondowoso	Prince Computer	Jl. Kh.Agus Salim 101 Blindungan Bondowoso Jatim 68212	0332-5635057 / 433358
Bone	Surya Indah Computer	Jl. Sukawati No.88, Bone, Sulawesi Selatan 92713	0481-2921039
Bontang	Ganeka Komputer	Jl. Bhayangkara No. 21 Bontang Kalimantan Timur 75311	054824542
Boyolali	XP Computer	Jl. Merbabu 18 Boyolali Jateng - 57311	0276-320044
Bukit Tinggi	Central Multi Computer	Jl. Raya Bukittinggi No. 120 Bukittinggi, Komp. Ruko Jambu Air Permai No.120, Sumbang 26181	0752-7003688; 0752-625876
Bulukumba	CV Media Computer	Jl. Cendana No.15, Bulukumba, Sulawesi Selatan 92518	0431-2587988
Ciamis	Micomp	Jl. Kh. A. Dahlan No. 5 Ciamis - Jawa Barat 46211	0265-772636
Cianjur	Nuhun Computer	Jl. Perintis Kemerdekaan No. 9, Jebrod, Cianjur 43213	0263-281418
	CV. Mitra Jaya Computindo (Digicom)	Jl. Moch Ali No. 62 Cianjur 43214	0263-260789 / 087778888909
	CV. Kurnia Komputer	Jl. Arif Rahman Hakim No. 56, Solokpandan Cianjur 43214	081585429100
Cibinong	PT. Gerai Servis Indonesia	Jl. Tegar Beriman No. 1 Blok A35 Pertokoan Cibinong City Center - Cibinong 16915	021-29335280
Cibubur	PT. Sukses Komputindo Abadi	Komplek Ruko Citra Gran, Jl. Alternatif Cibubur No.23, RT.001/RW.011, Jatikarya, Kec. Jatisampurna, Kota Bekasi, Jawa Barat 17435	021-8452024



# EPSON AUTHORISED SERVICE PARTNER

City	Name	Address	Phone
Cilegon	Star Media Teknik	Jl. Kepodang No. 69 Kav. Blok F Cilegon - Banten 42415	0812 1234 9045 / 087777101145
Cimahi	CV. Niscaya Berkah	Jl. Jendral Amir Mahmud No. 603 Rt 02/010 Kel. Setiamanah Kec. Cimahi, Cimahi Jawa Barat 40524	022 665 2991
Ciputat	Macindo Pusat (Mitra Adiyasa Cemerlang)	Jl. Otista Raya, Rt 01/010 No 53G, Ciputat Tangerang Selatan 15411	021 2274 4044
Cirebon	CV. Mitra Indexindo Pratama	Jl. Basalamah No.59E (Panjunan), Lemahwungkuk, Kota Cirebon, Jawa Barat, 45112	0231-211673; 0231-245568
	PT. HSN Tech Indonesia (Cirebon)	Jl. Panjunan No. 102-C Rt 01/08 Kel Panjunan Kec Lemahwungkuk Cirebon 45112	02318802191
Curup Rejang Lebong	Yuda Komputer	Jl. Jend. Sudirman, Kelurahan Air Putih Lama, No. 77 Kec. Curup - Rejang Lebong, Bengkulu 39112	0732-22828
Demak	Prima Komputer	Jl. Demak-Kudus No. 83, Tanubayan - Demak, Jateng - 59511	085292114696
Denpasar	MIP Denpasar	Jl. Raya Sesetan 53A, Ruko Sukma Cendana, Denpasar - Bali 80114	087875904915
	Rumah Printer	Gedung RTC Lt.2 No. E5, Jl.Diponegoro No. 136 Dauh Puri Klod, Denpasar 80232	081908233350
Depok	MBI Depok	Komplek Ruko Permata Depok Regancy Blok A No.2 Kec. Ratu Jaya, kota Depok, Jawa Barat	021-77810347/ 0817-7088-3444
Dumai	Maestro Komputer	Jl. P. Diponegoro No. 211 Dumai - Riau 28812	0823 8223 1199
Duri	Computer City	Jl. Jend Sudirman No.228 D Duri - Riau	0765- 598008/0765- 598006
Garut	Central Computer	Jl. Cimanuk 273 Garut - Jawa Barat 44118	0262-235420
Gorontalo	Square Computer	Jl. S Parman No. 36A Kel. Biawao, Gorontalo Sulawesi Utara- 96111	082188007111
Gunung Sitoli Nias	D. Com	Jl. Diponegoro No. 136, Gunung Sitoli - Nias, Sumut 22815	085262277088
IDI Rayeuk	Planet Computer Aceh	Jl. T Umar No. 6 Kec IDI Rayeuk Kab Aceh Timur 24454	085261470993
Indramayu	Personal Komputer	Jl. MT. Haryono No. 2B Sindang Indramayu Jawa Barat 45221	087873735050
Jakarta	PT Sentra Inovasi Solusindo	Jl. Agung Timur 4 Blok O1 No. 42 - 43 Sunter Jaya Jakarta Utara 14350	0216517216 / 0812 1868 6100
	MIP Cideng	Cideng Barat No. 47 G2 Rt/ Rw 009/04 Kelurahan Cideng Kecamatan Gambir Jakarta Pusat- 10150	021-22632749
	PT. Sinergi Tunggal (2)	Harco Mangga Dua Lt. 3, Blok B, No.51 Jakarta Pusat	021 6230 7508
	PT. Tekno Mandiri Abadi	Harco Mangga Dua Lt. 3, Blok B, No.51 Jakarta Pusat	081393714477
	PT. HSN Tech Indonesia (Mangga Dua)	Ruko Mangga Dua Square Blok H No. 28-29 14420	1500155
	PT. Teknika Sarana Gardian (Jakarta)	Jl.RS Fatmawati Rukan Golden Fatmawati (D'best) Blok J No.26, Jakarta Selatan 12560	021-75914343, 021-29042911
	MIP Warung Jati	Jl. Warung Jati Barat No.41B, Rt.8/Rw.5, Kalibata, Pancoran, Kota Jakarta Selatan, Daerah Khusus Ibukota Jakarta 12740	021-7946881
	PT. HSN Tech Indonesia (Fatmawati)	Ruko Itc Fatmawati Unit No. 7 Jl. Rs Fatmawati No. 39 Jakarta Selatan 12150	021-27513202
	PT. Faasri Utama Sakti	Jl. Raya Gading Indah No. 8 Kav. A4 Gading Permai, Jakarta-14240 (Belakang Mall La Piazza Kelapa Gading)	021-45844088
	Reksa Sekawan	Itc Permata Hijau Lt 3 Blok C11 No. 19 Jl.Ir. Soepeno Jakarta Selatan - Jakarta 12210	021-53663961
Jambi	PT. Berkah Tumbuh Bersama Indonesia (Bertubi)	Kompleks Ruko Mutiara Taman Palembang, Blok C10 No. 53 Jl. Outer Ring Road, Kel. Cengkareng Timur, Kec. Cengkareng Jakarta Barat 11730	085693572247
	CV. Eleven Jambi	Jl. Gatot Subroto No 10 Jambi 36134	0741-32088; 0741-7551843
Jayapura	CV. Master Computer	Jl. Percetakan Negara No. 94A, Jayapura - Papua 99111	0967-533588
Jember	Bitcom	P. Sudirman No. 58 Jember - Jatim 68118	0331-481822
Kabangjahe	CV. Mitra Computindo (d/h Era Baru Computer)	Jl. Padang Mas II No. 12, Kabangjahe Sumatra Utara 22115	0628-9032078
Karawang	Megatama Computindo	Jl. Arief Rahman Hakim No. 10B Karawang 41311	0267-8409202 / 08118499886
	Fisio Computer	Jl. HS Ronggo Waluyo No. 191. Rt.03/Rw.03. Ulekan Kelurahan Sukaharja. Kecamatan Telukjambe Timur Kabupaten Karawang, Jawa Barat. 41361	08119226174
Kebumen	Laris Elektronik (CV. Artha Guna)	Jl. Kusuma 103 Kebumen Jawa Tengah 54311	0287 -381623 / 6601033
	Utama Computer Kebumen	Jl. HM Sarbini No. 66 Kebumen 54316	0287382930
Kediri	Sumber Teknik Kediri	Jl. Joyoboyo 25E Banjaran, Kota Kediri Jawa Timur 64129	0354-688880
Kendari	Mentari Komputer	Jl. Dr Sam Ratulangi No.14 Mandonga kendari 93717	085242245196
Ketapang	Metro Computer	Jl. R. Suprpto No. 88, Ketapang, Kal-Bar 78812	0534-34355; 0534-35900
Kisaran	CV. F3i	Jl. Cokroaminoto No. 147 Kisaran Sumut 21214	0623 - 43647
Kotamobagu	Carper Computer	Jl. Veteran No. 21 Kel. Motoboi Kecil, Kotamobagu Komp. Manggala Sport Hall - Sulut 95711	0434-23338
Kuala Simpang	Logica Kreasi	Jl Iskandar Muda No 11 Kuala Simpang - Aceh Tamiang 24475	0641-32252
Kuningan	Zigma Comp	Jl. Re. Martadinata 33 Cijoho Kuningan - 45513	0232-874608
Kupang	Duta Multi Computer	Ruko Lontar Permai Jl. Raya Wolter Monginsidi III Blok A 21 Kupang - NTT 85111	0380-828333/ 08308441428 / 08113829998

# EPSON AUTHORISED SERVICE PARTNER

City	Name	Address	Phone
Kutai Kartanegara	EVG Computer	Jl. Balikpapan-Handil II Rt.04 No.08 Gn. Malang, Sungai Seluang, Samboja, Kutai Kartanegara, Kaltim - 75271	0542-7215458
Kutace	CV. Cybertech Communication	Jl. Jendral Ahmad Yani Kutacane Kab Aceh Tenggara Aceh 24651	06292524161
Lamandau	My Computer dan Elektronik	Jl. Tjilik Riwut Rt. 02A Samping SDN Nanga Bulik Lamandau Kalimantan Tengah 74162	081220243666
Lampung	PT. HSN Tech Indonesia (Lampung)	Jl. Teuku Umar No. 157 Kedaton Lampung 35132	0721-705430
Lhokseumawe	UD. Dizona Computer	Jl. Samudera Baru No. 10, Simpang Empat, Lhokseumawe, Aceh 24351	08126920233
	CV JCom	Jl. Merdeka II No. 2&3 Kuta Blang Kec Banda Sakti Kota Lhokseumawe 24351	081263678511
Lubuk Linggau	Sigma Komputer	Jl. Yos Sudarso No. 19, Lubuk Linggau, Sumsel 31621	0733-324828
Lubuk Pakam Deli Serdang	Arttech Komputer	Jl. Cokroaminoto No. 53 Lubuk Pakam - Deli Serdang - Sumut 20512	(061) 77212430 / 7952848
Lumajang	Lab Persada Computer	Jl. Wijaya Kusuma No. 11 Lumajang Jawa Timur 67315	0334-811411 / 0334-888221
Luwuk Banggai	Mitra Mandiri (Jaya Raya Com)	Jl. Sam Ratulangi No.141 Luwuk Banggai -Sulteng 94712	0461-21225
	CV. Maleo Komputer	Jl. MT Haryono Lalong Shopping Center Blok A No. 2 Luwuk Banggai Sulteng 94712	085323456709
Madiun	Astro Madiun	Jl. Hos Cokroaminoto 53, Kejuron, Taman, Madiun - Jatim 63132	0351-472799
	Maju Hardware	Plaza Matahari Jl. Pahlawan No.38-40 Madiun - Jawa Timur 63121	0351-481644
Magelang	Mikro Magelang	Jl. Tidar 24, Magelang Jawa Tengah 59214	0293 363453
Majalengka	Gemilang Prakarsa (Alfanet)	Jl. Kh. Abdul Halim No. 176 Majalengka - Jawa Barat 45418	0233-8285500
Makassar	Ariel Computer	Jl. G. Latimojong 163 A, Makassar. Sulawesi-Selatan 90141	0411 3610310
	Lestary Computer	Jl. H. Oesman Jafar No. 2 E, Makassar. Sulawesi Selatan 91111	0411-3619698/ 0411-3612654
	MIP Makassar	Jl. AP. Pettarani Kompleks Pettarani Center Blok B12 Bua Kana, Rappocini, Kota Makassar Sulsel 90233	0411 - 4669162
	Makassar Print	Mtc Karebosi Lt.2 Blok P3A-B, Jl. Jend. A. Yani No. 47, Makassar - Sulsel 90174	0411-2558484
Malang	Angkasa Computer Center	Jl. T.G.P No. 1, Malang. Jawa-Timur 65112	0341 351000/ 0341 323222
	CV. Trijaya Mandiri	Jl. Bukit Barisan No.3 Kav. 1 Malang 65112	0341559959
	PT. Teknika Sarana Gardian (Malang)	Jl.Terusan Sulfat Kav.2 No.69 Pandanwangi, Blimbing Malang 65139	085109335522
Mamuju	Mahadewa Computer	Jl. Jend. Sudirman Kav 10 No. 2, Mamuju - Sulawesi Barat 91512	085100723588
Manado	PT. Master Media	Ruko Megasmart 5 No.11 Boulevard Jl. Pierre Tendean Manado - Sulut 95111	0431-8821658
	Lestari Computer	Jl. Garuda No. 82 Wena Utara Manado Sulawesi Utara 95111	62 431 8880130
	Intertech Computer	Jl. Aipda K.S Tuban No. 25 Istiqlal Manado, Sulawesi Utara 95121	0431 863560
Manokwari	CV. Galerindo Komputama (Itech Manokwari)	Jl. Drs. Esau Sesa Wosi, Manokwari (Samping X Advertising) 98312	'081342012387
Mataram	Revayah Mataram	Jl. Sriwijaya, Pertokoan Sriwijaya No 9, (Depan Kura-Kura, Samping Indomart) Mataram - Lombok 83127	0878-6580-6395
Medan	MIP Medan	Jl. Prof. HM. Yamin Sh No.448, Sei Kera Hulu, Kec. Medan Perjuangan, Kota Medan, Sumatera Utara 20222	061-4553195
	Golden Dragon	Jl. Veteran No. 14D / 28 Medan - Sumut 20231	061-4567822; 061-77273158
Merauke	Padi Komputer	Jl. Parakomando No: 99 Merauke - Papua 99614	0971 - 322688
Metro	Zona Computer	Jl. Ah Nasution No. 67 A Kota Metro Lampung 34112	0725-48685
Meulaboh	CV. Multi Media	Jl. Manekro No. 38 Jurong V Gampong Kec Johan Pahlawan Meulaboh Aceh 23614	06557551722
Muara Bungo	PT. Mitra Komputer Bungo	Jl. Jend Sudirman KM 0 No. 67 Rt.09/02, (Sebelah Danamon & Rm. Jasum), Pasar Muara Bungo, Jambi 37212	0747-7331074
Nanga Pinoh	Komdisc Store.com	Jl. Juang Km. 2 No.77, Desa Tj. Niaga, Nanga Pinoh - Kalbar 79672	0568-22888
Pacitan	Surya Abadi Computer	Jl. Imam Bonjol No.34 Pacitan Jawa Timur 63512	0357-884534
Padang	Sinar Mulia Padang	Jl Belakang Tangsi II No 3A Padang - 25118. (Service)	62 751 28861; 0751-28841
	CV. Maxindo	Jl. Kp. Nias V No. 7, (Belakang Pondok), Padang - Sumbar 25211	0751-38837; 0751-39119
	PT. HSN Tech Indonesia (Padang)	Jl Veteran No. 75C Padang 25117	075-1891116
	PT. Semangat Berkat Jaya (Jbros Computer)	Jl. AR. Hakim No. 3B Padang Sumatera Barat 25211	075130383
Palangkaraya	Abadi Mitra Computer II	Jl. Galaksi Raya No. 7D, Palangkaraya - Kalteng 73111	0536-3238613
Palembang	Multikom	Jl. Lingkar I No. 22, Palembang. Sumatera-Selatan 30113	0711 316008 / 0711 358205
Palopo	Aruna Multi Computer	Jl. Andi Kambo No. 19C Palopo - Sulsel 91921	0471-326461
Palu	Meteor Computer	Jl. Sedap Malam No. 10B Besusu Tengah Palu Timur Sulawesi Tengah 9411	0451-455896
	Sara Com	Jl. S. Parman No. 61 Palu 94111	0451-4706614 / 085397751745

# EPSON AUTHORISED SERVICE PARTNER

City	Name	Address	Phone
Pamekasan	Sarana Inti Data	Jl. Trunojoyo No. 115 Pamekasan, Madura - Jatim 69317	0324-3510744
Pamulang	PT. Anugrah Sejahtera Sejati Madani (ASSM)	Komplek Rukan City Walk Blok C2 No. 08 Jl. Pondok Cabe Raya Pamulang Tangsel 15418	0217435364
Pangkal Pinang	CV. Duta Bintang Utama	Jl. Depati Hamzah No. 352 Pangkal Pinang Bangka 33684	0717-434485; 0717-9100526
Pangkalan Bun	Artha Computer	Jl. Kawitan I Pangkalan Bun - Kalteng 74112	0532-24567
Parigi	CV. Libra Com	Jl. Trans Sulawesi Kel Kampal Parigi Sulawesi Tengah 94471	085398852011 / 0811454530
Pasuruan	Aneka Sarana Computer	Jl. R.A. Kartini No. 12 Bangilan, Panggunrejo, Pasuruan - Jawa Timur 67114	0343-423739
Pati	Pati It Klinik	Jl. Kolonel Sunandar- Pati (Utara Stadion Joyokusumo Pati) 59163	085740526029
Payakumbuh	Indocomputer Payakumbuh	Jl. Soekarno Hatta No. 39, Payakumbuh Sumbar (Depan Rumah Bersalin Annisa) 26225	0752-93705
Pekalongan	Mitra Komputer	Jl. H.A. Salim No. 63 Pekalongan 51127	0285-435431
Pekanbaru	Multi Media Computer	Jl. Prof Moh Yamin Sh No 55B Pekanbaru. Riau 28155	0761-46814/ 0761-856856
	Dwiwira	Jl. Dr Setia Budhi No. 107A Pekanbaru 28144 - Riau	0761-25977 / 0761-25189/0761-28891
Pemalang	CV. Irama Putra Mandiri	Jl. Melati No. 09 Rt 005/012 Kel Palutan, Kec Pemalang Jawa Tengah 52311	081129975
Pematang Siantar	Asia Komputindo	Jl. Kartini No. 32E Pematang Siantar Sumut 21112	0622-5890388
Pidie Jaya	CV. Prima Jaya	Jl. Iskandar Muda No. 20 Kec Meureudu Kab Pidie Jaya Prov Aceh 24186	08126966728
Pontianak	Metro Computer	Jl. Gajah Mada No.87, Pontianak. Kalimantan-Barat 78123	0561- 742555/0561- 741610
	Datacom	Jl. Setiabudi No. 97A, Pontianak. Kalimantan-Barat 78122	62 561 739571; 62 561 748905
	CV. Irama Komputer	Jl. Prof M. Yamin RT 001/RW 001 Kel Kotabaru Kec. Pontianak Selatan Kalimantan Barat 78121	0811-5655-553
Probolinggo	Ridicomp	Jl. Ahmad Yani No. 152 Mangunharjo, kec Mayangan, Probolinggo -Jawa Timur 67217	0335-425858
	UD. Global Tech&Service	Jl. Mastrip 177 Kanigara Probolinggo Jatim- 67213	0335-434009 / 430447
Purwakarta	Putri Komputer	Jl. Ibrahim Singadilaga No. 64 Koncara - Purwakarta 41112	02648301614
Purwokerto	Indo Komputer Purwokerto	Ruko Satria Plaza Blok A No 1, Jl. Jend Sudirman, Purwokerto. Jawa Tengah 53114	0281-632500
	Tripio Computer	Jl. Dr. Angka No. 85 A, Purwokerto-Jawa Tengah 53114	0281-621908 / 081215428888
Putusibau	Mitra Computer	Jl. Komyor Ruko No. 2 Putusibau Kalbar 78711	0567-22835
Raha	RC Computer	Jl. Gatot Subroto (Depan Polsek Katobu) Kota Raha, Wamponiki, Katobu, Muna - Sulawesi Tenggara 93613	0852 41747222
Rantau Prapat	Central Computer Rantau Prapat	Jl. K.H.A Dahlan No. 75 Rantau Prapat 21413	0624-327475
Rengat	X2 Computer	Jl Veteran No.43 Rengat - Riau	082381953690 / 081275326008
Sabang	Liberty Baru	Jl. Perdagangan No.5 Kuta Bawah Barat Kec Sukakarya Sabang Aceh 23512	08526060880
Salatiga	Aston System	Jl. Imam Bonjol No.28 Salatiga	0298-326431
Samarinda	LiData Comp	Jl. Lambung Mangkurat 40, Samarinda. Kalimantan-Timur 75117	0541-739127 / 0541-736127 / 0541-7773002
Sambas	Pedoman Computer	Jl. Gusti Hamzah No. 67 Sambas - Kalbar 79462	085332340965
Sampit	My Digital (CV. Teknologi Dunia Satu Keluarga)	Jl. Kapten Mulyono No.98A, Sampit - Kalteng 74323	0531-31335 / 085257667864
Sanggau	Zoom Computer	Jl. Jend Sudirman No.19, Sanggau Kalbar 78512	0564-22181
Sekadau	CV. Neo Computer	Jl. Merdeka Timur Km. 02 Sekadau - Kalbar 79582	0564-2021012
Semarang	Compumart	Jl Singosari Raya No. 9 Semarang 50242	024 831 1199
	MIP Semarang	Jl. Indra Prasta No. 76B, Semarang - 50131	024-7643197
	CV. Bumi Raya Indonesia (Hitech Computer)	Komplek Pertokoan Jumatan Block B 49 Purwodinatan, Semarang Tengah, Semarang Jateng - 50137	024-3553888
Sengkang	Master Computer Sengkang	Jl Sulawesi No 15 Wajo Sulawesi Selatan 90911	0485-21880
Serpong	PT. Kreatif Sinergi Teknologi	Jl. Raya Rawa Buntu No.2 (Jl. Dahlia), Kel. Rawa buntu, Kec Serpong, Kode Pos 15318	0858 9710 1388
Sibolga	CV. Modern Computer	Jl. Imam Bonjol No. 107 Sibolga Tapanuli Tengah 22522	0631-27777 - 27888
Sidikalang	UD. Mitra Computer	Jl. S.M Raja No. 19 Kel Batang Beruh Kec Sidikalang Sumatra Utara 22212	0627424150
Sidoarjo	Matahari Makmur Computer	Jl. Diponegoro No. 78, Sidoarjo - Jatim 61213	031-8069233
Sigli	Orion Computer	Jl. Prof. A. Majid Ibrohim No.104 Sigli Aceh 24151	08526000555
Singaraja	CV. Indotech	Jl. Ahmad Yani No. 55 Singaraja Kel Kaliuntu Kec Buleleng Bali 81114	0362-28123
Singkawang	CV. Central Computer	Jl. Yohana Godang No. F9 Rt. 26/07 Melayu - Sigkawang Barat Kalbar 79112	0562-638832

# EPSON AUTHORISED SERVICE PARTNER

City	Name	Address	Phone
Sinjai	CV. Amalia Utama Computer	Jl. Manimpahoi No. 1 Kel Bongki, Kec Sinjai Utara, Sulawesi Selatan 92615	'085225393335
Sintang	CV. Gloria Komputer	Jl. Wirapati Rt 001/001 Kel Kapuas Kanan Hulu, Sintang Kalimantan Barat 78614	085245872371
	Mitra Computer Sintang	Jl. Y.C Oevang Oeray, Kel Baning kota, Kec Sintang Kalimantan Barat 78612	085245054850
Situbondo	Sigit Komputer	Jl. Cempaka No. 18B Patokan Situbondo Jawa Timur 68312	0338673408
Sorong	Toho Computer	Jl. Pramuka ( Depan Polresta ), Sorong Papua Barat 98411	0951- 3173057
Subang	MS Computer	Jl. Arief Rahman Hakim No. 35 Subang - Jawa Barat 41213	0260-416126 / 7707733
Subulussalam	Esa Computer	Jl. Nyak Adam Kamil Dusun Pemancar Kel Penanggalan Barat, Kec. Penanggalan Kota Subulussalam Prov Aceh 24782	081269396969
Sudimara	PT. Tiga Samudera Adiperkasa	Komplek Ruko Kuta - Ubud Village Block A-7 Jl. Hos Cokroaminoto, Sudimara Timur Tangerang Selatan 15151	021-2905 2864
Sukabumi	RNY Com	Jl. Ahmad Yani No. 216/232 kec.Cikole. Sukabumi Jawa Barat 43112	62 266 221079 / 0266-217890
Sukadana	KS Computer	Jl. Tanjung Pura Desa Sutera Kec Sukadana Kab Kayong Utara Kalimantan Barat 78852	082155505552
Sukamara	Sahabat Komputer dan Elektronik	Jl. Tjilik Riwut No. 30 Sukamara Kalimantan Tengah 74172	085252561656
Sumedang	CV. Semesta Komputama (Itstore)	Plaza Asia Sumedang GF 19-20 Jl. Prabu Gajah Agung No. 5 Sumedang Jawa Barat 45621	082118096595
Surabaya	PT Amtek Perkasa Internasional	Jl. Sidosermo Airdas Kav A9 Surabaya- Jawa Timur 60239	08113313344
	Abadi Cipta Komputer	Jl. Manyar Rejo 17 Menur Pumpungan, Sukolilo, Surabaya - Jatim 60118	031 5921236 - 37
	MIP Surabaya	Ruko Sentra Fortuna, Jl. Jaksa Agung Suprpto 39 Kav. 20, Ketabang, Kec Genteng Surabaya 60272	031-71758865; 031-5355460
	PT. HSN Tech Indonesia (Surabaya)	Jl. Kusuma Bangsa No. 25D Kel Ketabang Kec Genteng Surabaya 60272	0231-99299907
Surakarta	Prima Mitra Abadi	Jl. Veteran No. 205 Solo - Jateng 57155	0271-645350 / 0271-664847
	CV. Manxi Image Perkasa	Jl. Mh Tamrin No 67 Manahan Solo - Jateng (Depan Kantor Pos) 57143	0271 7462052 / 085100092986
Takengon	MVP Computer	Jl. Gatot Subroto No.424 Takengon Aceh Tengah 24519	081315378768
Tambun	CV. Matrix Mikro Computer	Ruko Tambun City, RH No. 09, Jl. Sultan Hasanuddin No. 60-80, Tambun - Bekasi Jawa Barat 17510	021-22137718
Tanah Grogot	C-Print	Jl. S. I Khaliludin Rt 013/04 Tanah Grogot Kab Paser Kalimantan Timur 76211	05435225250
Tanjung Balai Asahan	Star Computer	Jl. Sudirman No. 151 Tj. Balai Asahan Sumatra Utara 21332	0623-92060
Tanjung Balai Karimun	Techno Infinity	Jl. A. Yani No. 5 Rt 03/06 Kel. Meral Karimun, Tj. Balai Karimun - Kepri 29664	0777-327578/ 082388332230
Tanjung Morawa	Family Computer	Jl. Perintis Kemerdekaan No. 9, Tanjung Morawa B, Deli Serdang - Sumut 20362	061-7940358
Tanjung Pandan	DNP Computer	Jl. Telex Rt 06/02 Air Merbabu - Tanjung Pandan Belitung 33411	0719-9223528
Tanjung Pinang	Force Computer	Jl. Raja Ali Haji No. 10, Tj.Pinang - Kepri 29124	0771-26888; 0771-314354
Tarakan	Plus-Plus Computer	Ruko Gusher Block C-10 Jl. Gajah Mada Tarakan - Kaltara 77111	0551-36120 / 0551-5542796
Tasikmalaya	Planet Computer	Jl. Selakaso No. 4, Tasikmalaya Jawa Barat 46121	0265 332223
Tebing Tinggi	Mitra Utama Computer	Jl. Thamrin No. 125 Gg-Hh, Tebing Tinggi - Sumut 20628	0621-327690
Tegal	CV Indo Computer Tegal	Jl. Mayjen Sutoyo 14 Tegal 52125	0283-343500
	Graha Computer	Jl. AR Hakim No. 167, Desa/Kelurahan Mangkukusuman, Kec Tegal Timur, Kota Tegal, Provinsi Jawa Tengah	'0283350140
Tenggarong	CV. Sentral Solusi Sejahtera	Jl. Kartini No. 22 Rt. 18, Tenggarong- Kutai Kartanegara Kaltim 75512	0541-665938
Ternate	PT. Datagrid Maestro Tekno	Jl. Raya Jati No. 17, Rt 03/02 Kel. Jati Ternate Selatan - Maluku Utara 97716	0921-6205567 / 081244029788
Timika	CV. Ihsan Infotika	Jl. Bhayangkara No. 39 Koperapoka, Timika - Papua 99910	0852 44523545
Tj. Redeb Berau	G Comp	Jl. Pemuda No.77 Tanjung Redeb, 77311	0821-1669-2222 / 05542122
Tulungagung	Maxindo Computer Tulungagung	Jl. Diponegoro No. 76 Tulungagung - Jawa Timur 66217	0355-322288
Wonogiri	Raya Komputer (CV Raya Solusindo)	Jl. Ahmad Yani No. 56 Giripurwo Wonogiri - Jateng 57613	027-3323234
Wonosobo	Juzzy Computer	Jl. Manglosari No. 2B, Wonosobo Timur Jawa Tengah 56311	0286-323776 / 323034
Yogyakarta	MIP Yogyakarta	Komp. Ruko Kuning No. 8 Jl. Ring Road Utara Condong Catur -Yogyakarta 55281	0274-557502
	Dot Print	Jl. Petung 1, Paprangan - Jogjakarta 55321	0274-519725 / 085236139382
	PT. Teknika Sarana Gardian (Yogyakarta)	Jl.Kol. Sugiono No.63 Rt12/51, Kec. Keparakan, Kel. Mergangsari Yogyakarta 55152	0274-372614
	PT. HSN Tech Indonesia (Yogyakarta)	Komp Ruko Casa Grande No. 17 Jl. Ring Road Utara Sleman Yogyakarta 55281	[0274] 871116 / 871167

# EPSON AUTHORISED SERVICE PARTNER

CORPORATE SERVICE PARTNER			
City	Name	Address	Phone
Batam	PT. Terang Inti Sejahtera	Ruko Four Season Blok B No. 21, Taman Duta Mas, Batam Centre, Batam - Kepri 29463	0778 - 469123 / 085271503333
Bekasi	PT. Solusi Sukses Pratama	Ruko Sampoerna Square No. 12 Jl. Raya Kranggan No. 37A Bekasi Jawa Barat 17433	021-28672601
	PT. Hade Multi Solusi	Graha Hade Jl. Wibawa Mukti II No.115, RT.003/RW.006, Jatiluhur, Kec. Jatiasih, Kota Bekasi Jawa Barat 17425	021-29062502
	PT. Polar Solusindo Utama	Ruko Kemang Permai No. 3A Jl. Siliwangi KM. 1 Sepanjang Jalan Rawa Panjang Bekasi 17114	021-82438202
	PT. Harmony Sistem	Jl. Dalang No. 8 Rawa Lumbu Bekasi Jawa Barat 17116	021-82401323
Jakarta	PT. Air Mas Servisindo	Ruko Cobastroke KH Zainul Arfin 2 Komplek Ketapang Indah Blok B1 No.10 Ketapang, Jakarta Barat 11140	021-22636555 / 085290808080
	PT. Elang Mandiri Solusi	Pusat Niaga Roxy Mas, Jl. Kh Hasyim Ashari No.9-12, RW.8, Cideng, Kecamatan Gambir, Kota Jakarta Pusat, Daerah Khusus Ibukota Jakarta 10150	021-50111351
	PT. Mitra Niaga Gemilang	Komp. Ruko Wijaya Kusuma No. 6Ab Jl. Daan Mogot No. 48 Jakarta Barat 11460	021-5655579 / 08119796077
	PT. Password Ritel	Jl. Jendral S. Parman Kav 77, Wisma 77 Tower 1 Lt. 15 Slipi, Jakarta Barat 11480	021-5363207
	PT. Albeta Sukses Mandiri	Jl. Kedoya Duri No.38A, RT.19/04, Kedoya Kec. Kb. Jeruk Jakarta Barat 11520	0215819908
	PT. Graha Digital Niaga	Ruko Duta Indah Alpha 2, Jl. Peta Selatan, Rt 08/01, Kalideres Jakarta Barat 11840	021-54313240
	PT. Data Retail Solution	Perkantoran Plaza Pasifik B4/81 Jl. Boulevard Barat Kelapa Gading, Jakarta Utara - 14240	021-4587 5368 / 4587 5369
	PT. Setia Saptia	Jl. Gajah Mada No. 183-184 Glodok Taman Sari Jakarta Barat 11120	021-6296208 / 6499985
	PT. Intikom Berlian Mustika	Jl. Duren Tiga Raya No. 32 Rt 004/01 Duren Tiga, Pancoran, Jakarta Selatan 12760	021-52971700
	PT. Global Multimedia Technology	Jl. M Saari No 5 Rt 11/009 Sunter Jaya, Tanjung Priok, Tanjung Priok, Jakarta Utara 14360	021-22065580
Malang	CV. Tunas Abadi	Jl. Jakarta No. 45B Malang Jawa Timur 65145	0341-580520 / 0341-570385
Semarang	CV. Mediadata Sejahtera	Jl. Menteri Supeno No.44B, Mugassari, Kec. Semarang Sel, Kota Semarang, Jawa Tengah 50249	08888545545
Surabaya	PT. Cahaya Inti Prima (3D Print Computer)	ITC Mega Grosir lantai.2 Blok G5 No. 1-3A, Jl. Gembong No. 20-30 Surabaya 60141	031-5476706 / 087852496899
Yogyakarta	CV. Top Distribusi	Kepuh Gk 3/953, Klitren, Gondokusuman, Yogyakarta 55222	0274-555475 / 08197555475

LARGE FORMAT & INDUSTRIAL PRINTER			
City	Name	Address	Phone
Bekasi	PT. Mandiri Artha Solusi	Ruko Sampurna Square, No.15 Jl. Raya Hankam Jatiasampurna Kranggan Bekasi 17433 - Jawa Barat 17433	021-22813394 / 021-28672601
Depok	PT. Indonesia Graphic	Komplek Rukan Graha Depok Mas Blok A No. 5, Jl. Raya Arief Rahman Hakim, Depok Jawa Barat 16423	021-7829245 / 083808821483
Jakarta	CV. Media Grafindo	Green Sedayu Bizpark, Blok Dm.15 No.72 Jl. Daan Mogot Km.18 Jakarta Barat 11840	021-54315518 / 021-22520784
	PT. Mulia Mandiri Supply	Jl. Tongkol No. 6 BI, Ancol Pademangan Jakarta Utara- 14430	021-6910072
	PT. Samafitro Jakarta	Jl. Ir. H. Juanda No. 8 Jakarta Pusat - 10120	021-29495500
	PT. Aneka Warna Indah	Jl. Gn.Sahari NO.50A ,RT01/RW01, Gn.Sahari Sel, Kec.Kemayoran Kota Jakarta Pusat 10610	021-6511009
Serpong	PT. Laysander Technology	Ruko Golden Boulevard R/21 Serpong Utara Bsd Tangsel - 15322	021-53161450
Surabaya	PT Samafitro Surabaya	Jemur Wonosari, Jl. Jemusari No. 313 Sidosermo, Kec Wonocolo, Kota Surabaya Jawa Timur 60299	031-841 3027 / 031-847 7779
	CV. 7 Droplet	Green Mansion Residence Blok N No. 12A, Jl. Ambeng-ambeng Selatan, Ngingas, kec Waru, Kab Sidoarjo, Jawa Timur 61256	031-85587722
	CV. Wujud Unggul	Kompleks Pergudangan Indoserena Blok A-19, Jabon, Tambaksawah, Waru, Sidoarjo Jawa Timur	031-99691147
Surakarta	CV. Sinar Citra Pratama	Jl. Sutan Syahrir No 25 Solo 57129	0271 647630 / 0811295876

# EPSON NATION-WIDE DISTRIBUTOR

## EPSON NATION-WIDE DISTRIBUTOR

Company Name	Address
<b>CV TUNAS ABADI</b>	Jl. Simpang Balapan No. 1, Kota Malang
<b>PT ACA PACIFIC</b>	Satrio Tower Lt 19. Unit 01 JL. Prof. Dr. Satrio Kav. C4, Kel.
<b>PT GLOBAL MULTIMEDIA TEKNOLOGI</b>	Ruko Mega Grosir Cempaka Mas Blok G No.11 RW.8 Kel. Sumur Batu, Kec. Kemayoran Jakarta Pusat. 10640
<b>PT KOMINDO BIZOLUSI</b>	Pusat Niaga Roxy Mas, Jl. KH. Hasyim Ashari No.9-12, RW 8, Kel. Cideng, Kec. Gambir, Kota Jakarta Pusat DKI Jakarta, 10150
<b>PT MITRA NIAGA GEMILANG</b>	Komp. Ruko Wijaya Kusuma No. 6 AB Jl. Daan Mogot No. 48 Grogol Petamburan Jakarta Barat 11460
<b>PT PASIFIK INTERNUSA</b>	Sudirman 7.8 Tower 1 Lt.26Jl. Jendral Sudirman Kav 7-8 Kec. Tanah Abang, Kota Jakarta Pusat. DKI Jakarta, 10220
<b>PT REYCOM DOCUMENT SOLUSI</b>	Pakarti Centre Building 6th FloorJl. Tanah Abang 3 no.23,25,27 Jakarta, 10160 Telephone 021-38901948
<b>PT SETIA SAPTA</b>	Jalan Gajah Mada 183-184, Jakarta 11120
<b>PT SURYA SARANA DINAMIKA</b>	Komp. Mega Sunter B-40, Jl. Danau Sunter Selatan, Jakarta
<b>PT SYNnex METRODATA INDONESIA</b>	APL Tower Lantai 42 Suite 1 - 8, Jl. Letjen S. Parman Kav. 28, Kel. Tanjung Duren Selatan, Kec. Grogol Petamburan, Jakarta Barat

# EPSON AUTHORISED MASTER DEALER

## ACEH

SURYA ABADI PROJECTOR

## BALIKPAPAN

WIDYA WISESA

## BANDUNG

ANEKA NIAGA GLOBAL - SARANA SOLUSINDO SEJATI - GREAT PRIMA LESTARI -  
COMPUMAX MITRA SEJATI - PRIMATECH VISINDO - VISUAL INDO PERKASA - WIJAYA  
MANDIRI - MEGA - LIEMARGA EKAPUTRA MANDIRI - MASSCOM

## BANJARMASIN

BORNEO PRIMA UTAMA JAYA - DATACOM

## BATAM

KARYA MURA NIAGA - TERANG INTI SEJAHTERA

## BEKASI

SOLUSI SUKSES PRATAMA

## BOGOR

ZOOM INFOTEK TELESINDO

## DENPASAR

AYU WIRA - ANEKA PIRANTI Cipta - CITRA SARANA SOLUSI

## JAKARTA

KARISA SUKSES ABADI - TEGUH KOMPUTAMA - SUPER COMPUTINDO - MITRA INDO  
BHAKTI UTAMA - RAJAWALI MAHKOTA TEKNOLOGI - IS PRATAMA ABADI - FOCUS  
INFOTAMA - TOPSON INDONESIA - DATA JAYA ABADI - INTIDATA SUPPLIES - HARYA PILAR  
UTAMA SUKSES - KARYA ADHI GEMILANG - DIGITEC JAYA INDONESIA - PRIMROSE  
CEMERLANG LESTARI - FLEXIPOS MITRA ABADI - MAKRO INFORMASI TEKNOLOGI -  
PRATAMA Cipta LESTARINDO - VIN SOLUSI COMPUTAMA - DATA RETAIL SOLUTION - EGP  
DISTRIBUSI - KHATULISTIWA JAYASAKTI ABADI - MILENIA MULTIVISI - PASSWORD RETAIL  
SISTEM INDONESIA - PROSHOP MEGA JAYA - DARMAWAN OPTIMA PROJEKTOR -  
MEGATRONIX MITRANIAGA - CENTRAL TECH GLOBAL SOLUSI - ARTA MUARA - YAKIN  
ANUGERAH PERKASA - ANUGERAH SEJAHTERA COMPUTER - MULTICASA - ITKLIK  
INDONESIA - JAYA UTAMA COM - X-COM MEDIA - MULTI MASTER MANDIRI - GRAHA  
SARANA INFOTAMA - IMAGO INOVASI INDONESIA - FESTINO INDONESIA - GA TIGA BELAS -  
SAKATA INX INDONESIA - KREASI SARANA PRIMA - MAHA DANA WIKASITA -  
PILAR GLOBAL SOLUSI

# EPSON AUTHORISED MASTER DEALER

## JAMBI

ANDIKA SURAYA KOMPUTER • ELEVEN KOMPUTER

## MAKASSAR

ARIEL CREATIVE ELEVATION • LASER COMPUTINDO • CAHAYA SURYA COMPUTER • KOMETINDO  
KOMPUTAMA • VICTORIA JAYA KOMPUTAMA

## MANADO

HARMONI SUKSES MANDIRI • MEGA INFORMASI

## MEDAN

METRO ELEKTRONIK • ABC ASIA • PARON INDONESIA

## PADANG

SEMANGAT BERKAT JAYA • SINAR MULIA ANDALAS INFOCOM

## PALEMBANG

MULTIKOM • BOBBY PUTRA PRATAMA • MULTI DATA PALEMBANG

## PEKANBARU

DWIWIRA PUTRA DINAMIKA • RETYAN COMPUTER

## PONTIANAK

ANEKA MULTI SUKSES ABADI • IT SOLUSINDO • IRAMA KOMPUTER



# EPSON AUTHORISED MASTER DEALER

## PURWOKERTO

GLOBAL TECHNOLOGY SOLUTION

## SAMARINDA

MITRA JAYA MANDIRI • LIDATA COMPUTER

## SEMARANG

COMPUTEK INFOMART INDONESIA • GLOBAL KARUNIA TECHNOLOGY •  
YESTOYA ABADI • MULTI CASA SEMARANG

## SERANG

GEMILANG KOMPU SOLUSINDO

## SERPONG

INDOCITRA VISITAMA MANDIRI

## SOLO

SADAR JAYA MANDIRI • TUNGGAL OPTI PERSADA

## SURABAYA

RAYA PERSADA SOLUSINDO • KODE NIAGA TAMA • LOGI DATA TEKNOLOGI • ANEKA CEMERLANG •  
KOMPUTER • SURYA SATWIKA • SURYA MAKMUR KREASINDO • KREASINDO CIPTA NUSANTARA •  
MULTI SARANA COMPUTER • GADING MURNI

## TANGERANG

LAYSANDER TECHNOLOGY

## YOGYAKARTA

RAKA PERKASA TEKNOLOGI SINAR • ABADI MULTIMEDIA • COMPUTA

# EPSON AUTHORISED DEALER

## ACEH TAMIANG

LOGICA KREASI

## AMBON

GALAXY COMPUTER • HI-TECH COMPUTER

## ATAMBUA

THONBERS GEMILANG TECHNOLOGI

## BALIKPAPAN

BENTHENK KOMPUTER • DATA COM • FULUSSO COMPUTER • GATRA KOMPUTER • GREEN COMPUTER • TIARAKOM

## BANDA ACEH

ANGKASA PUTERA ABADI • DUNIA KOMPUTER • PUTRA SOLUSINDO COMPUTER • RACOM • REFILL CENTER • SELAMAT • SIMBADDA COMP • VIRTUAL COM • DEDE COMPUTER • METRINDO.COM • PC ONE TECHNOLOGY (PLAZA IT)

## BANDAR LAMPUNG

ALAM PRIMA KOMPUTER • FAJAR AGUNG INDO CEMERLANG • GLOBAL JAYA (METRO COMPUTER) • MAHIR COMPUTER • SENTRA COMPUTER • SINAR SUKMA WIJAYA

## BAGAN BATU

PT ROKAN INOVASI TEKNOLOGI

## BANDUNG

MAJESTY COMPUTER • CV MEGA • ROYAL COMPUTER • EXPO COMPUTER • FAEYZA GEMILANG ABADI • CV PILAR ABADI • IT ZONE / PT TEGUH JAYA BERSAMA • MENTARI • LOGI SHOP • STOP N SHOP • PT SARANA SOLUSINDO SEJATI • BEC COMPUTER • LAPTOP SQUARE • MEDIA TOUCH • PRIMA PARAHYANGAN KOMPUTER • CV COMPUMAX MITRA SEJATI • ASTERIX • VISICOM • TOTIN COM / TOKO TINTA • BEST PRINT • PT SUPERTECH INTERNUSA • CV HERBICOM • RETAIL SOLUTION • MERAUKE • CV GATECOM TECHNOLOGY • CV PERSADA MANDIRI • SINAR TERANG • INDOPRINT • MEKAR JAYA • SINAR ABADI • YOSIKO • GENERASI STATIONERY & COMPUTER • MEDIADATA • PUBLIC AGENCY • PRIMA LESTARI • GOLDEN MULTI PRIMA

## BANGKA

CV SENTRA KOMPUTER • CV DEDE COMPUTER

## BANGKA BELITUNG

CV. MULTI SARANA UTAMA

## BANJAR BARU

TWINCOM / TWIN GROUP

## BANJARMASIN

ANEKA COMPUTER • ANUGRAH TEKNOLOGI COMPUTER • BANDUNG USAHA JAYA • BERLIN KOMPUTERINDO • BORNEO MULTIMEDIA JAYA • DATACOM • INFO TECHNIC (INFO COMPUTER CENTRE) • NUSANTARA JAYA

## BANYUWANGI

ASTON PRINTER BANYUWANGI • ASTERIX COMPUTER • BINA USAHA • MEDIA CIPTA • MULTIKOM • SAHABAT COMPUTER • SINAR KENCANA • SENTRA DINAMIKA

## BATAM

AIR MAS BATAM JAYA • AZ TECHNOLOGY • INK SHOP CENTER • IT STORE COM • PRO COMPUTER • SKY COMPUTER • STAR COMPUTER • TEKNOLOGI BATAM SOLUSINDO

## BATURAJA

CV. JASU SRI WAHYU • ANITA KOMPUTER

## BAU BAU

SATELLITE

## BEKASI

XYZ GOPRINT INDONESIA • INKLOUD • PT. HARMONY SISTEM

## BELILAS

INTEL KOMPUTER

## BELITUNG

MULIA JAYA

## BENGKALIS

SMART COM • CV DWI MANDIRI (BCS) COMPUTER

## BENGGAYANG

BANLIE COMPUTING • HARINDO UTAMA

# EPSON AUTHORISED DEALER

## **BENGKULU**

BIRU TEKNOLOGI MULTIMEDIA • WIRA KOMPUTER

## **BERAU**

G KOMPUTER • METRO RAYA INTIPRIMA • PERDANA MAKMUR JAYA • ROBINSON KOMPUTER

## **BIAK**

HANJAYA GEMILANG

## **BIMA**

SENTRAL MUSLIM • TIGA COMPUTER

## **BINJAI**

ENTER COMPUTER BINJAI • ZIP COMPUTER

## **BITUNG**

STAR COMPUTER BITUNG

## **BLITAR**

DALLAS KOMPUTER • SENTRA MEDIA

## **BOGOR**

C93 • SETIA JAYA COMPUTER • ZOOM INFOTEK TELESINDO • ANEKA CITRA COMPUTER • MEGA PERKASA

## **BOJONEGORO**

ASTON CAHAYA GEMILANG • HITECH COM • INDO SARANA MAKMUR (INDOSARANA COMPUTER) • JEVA MULTI SEJAHTERA

## **BONDOWOSO**

PRINCE COMPUTER

## **BONE**

ABIF COMPUTER • KURNIA COMPUTER BONE • SURYA INDAH COMPUTER

## **BONTANG**

BINTANG PERDANA PRIMA

## **BOYOLALI**

MEDIATAMA • XP COMPUTER

## **BREBES**

TERA COMPUTER

## **BUKIT TINGGI**

CENTRAL MULTI COMPUTER • CITRA TERAMPIL • VGA KREASI SYSTEM

## **BULUKUMBA**

ARAKITA COMPUTER • MEDIA KOMPUTER BULUKUMBA

## **BULUNGAN**

GRACIAS

## **CIAMIS**

ANUGERAH COMPUTER • MEDIA INFORMATIKA

## **CIANJUR**

CV KURNIA PRINT SOLUSINDO • CV MITRA JAYA KOMPUTINDO • PT MULIA SARANA ABADI • CV TANOKO

## **CILACAP**

ASTON PRINTER • BASS COMPUTER

## **CIMAH**

CV NISCAYA BERKAH • CIMAH UTAMA KOMPUTER

# EPSON AUTHORISED DEALER

## CIREBON

ANEKA NIAGA SENTOSA • ASIA COMPUTER • GRAND COMPUTER • INDEXINDO COMPUTER • JAYA PRATAMA COMPUTINDO • MULTINET COMPINDO • PARAHANGAN COMPUTER

## DELI SERDANG

ARTTECH KOMPUTER

## DEMAK

PRIMA KOMPUTER

## DENPASAR

ADI RAYA KOMPUTER • ANEKA PIRANTI CIPTA • ARTHA BALI COMPUTINDO • ASTIKOM • AURORA COMPUTER • BALI SATU COMPUTER • BALLYONI SAGUNA • BALI TECHNO (BTG COM) • DNA KOMPUTINDO • FX BALI • GLOBAL JAYA SEJAHTERA • INDOTECH • Z4COMP

## DEPOK

CV ANUGERAH JAYA • PT INSIDE INDO JAYA • BERKAT TEKANG • MEGA PERKASA COMPUTER (MPC) • PT GIAN TEKNOKINDO SOLUSI

## DUMAI

TOKO JEFINDO TEKNOLOGI • CV SOLUTION TECHNOLOGY (LIQUID COM) • MAESTRO KOMPUTER • DELTA TEKNOLOGI CORPORINDO

## DURI

TOKO COMPUTER CITY • ELITE COMPUTER

## ENDE

DELTACOM

## FLORES

ERA CIPTA JAYA

## GARUT

CENTRAL COMPUTER

## GORONTALO

GORONTALO COMPUTER • ISTANA DISC COMPUTER • PROTECH COMPUTER • ROCKY MITRA SUKSES • SQUARE GORONTALO • TAMPA PRINTER

## GRESIK

TERACOM CIPTA PERSADA

## JAKARTA

MEGATRONIX MITRANIAGA • DIGITEC JAYA INDONESIA • KALLISTA KOMPUTER TEKNOLOGI • DUTA TEKNOLOGI NUSANTARA • BERKAT MEGAH SEJAHTERA • AT COMPUTER • BINTANG RAYA KOMPUTAMA • DAS LIVIA • DATAPOINT • DUNIA MAS COMPUTER • MULTI KARYA SUKSES • MY STUDIO • PETRASINDO COM • PLAZA COMPUTER • SC TEKNOLOGI • STAR DISC COMPUTER • US COMPUTER • USE OFFICE EQUIPMENT • ZEBE COMPUTER • MASTER KOMPUTER • BUDGET TECHNOLOGY • LIGA INTI RAYA (JAYA ABADI COMPUTINDO) • PERFECT COMPUTER • FULCOMAS JAYA • SYN PRINT • SINGA MULIA ABADI (LION ELECTRONICS) • NIRWANA KOMPUTINDO (NK) • PHOENIXINDO SUKSES PERKASA • ARMINDO MANDIRI • F2F COM • NATHAN SUKSES MAJU JAYA • COMPUTER EXPRESS • SUN JAYA COMPUTER • CIPTA MITRA SOLUSINDO • MANDIRI INDO TECHNOLOGY • VENUS SHOP • GOLDEN SWAN COMPUTER • ABACUS • BASIS COMPUTER • MILENIA MULTIVISI (GRAND COMPUTER) • GLOBAL DATA CENTER • NANDA COMPUTER • DIGITEC JAYA INDONESIA • SOLUSI IDEA INFORMATIKA • SYIFA JAYA SEJATI • SUKSES KOMPUTINDO ABADI • METEOR INDORETAIL COMPUTAMA • DUNIA KOMPUTER INDONESIA • EXCELINDO SEJAHTERA • AGRES INFO TEKNOLOGI • FIXPRINT • TEKNO MANDIRI ABADI • ADHITECH • BINTANG RAYA KOMPUTAMA • DWI TUNGGAL SEJAHTERA • INTEGRA INFOTEK SOLUSITAMA • PANEN RAYA • SUMBER BERKAT • SUPER COMPUTINDO • TAXON • SIS KENCANA MAS • PRIMAX COMPUTER • IS PRATAMA ABADI • DUTA 1 (ONE) • INTI RAYA • TUJUH ANUGRAH ABADI • SANGKAKALA • TOKO BUKU KEBAYORAN • METAMA COMINDO NUSA • JAYA MAKMUR • EASY MITRA • ARMINDO MANDIRI • BERKAT ABADI KOMPUTER • DATAPOINT • ARMINDO MANDIRI • DIGITEC JAYA INDONESIA • BINTANG RAYA KOMPUTAMA • DATAPOINT • GLOBAL COMPUTINDO • ARMINDO MANDIRI • CIPTA MITRA SOLUSINDO • INVIA • SINARMULIA SUKSES MAKMUR • JAYA KREASI CIPTA • DIGITEC JAYA INDONESIA • DUNIA KOMPUTER INDONESIA • ARMINDO MANDIRI • TUAIAN BERKAT • KREASINDO GLOBAL GROUP • WIDJOYO MITRA ABADI • FLEXIPOS MITRA ABADI

## JAMBI

ANDIKA SURAYA KOMPUTER • MASTERDATA JAMBI • PRIMA CITRA KOMPUTER • SYSTECH COMPUTER • TOMART COMPUTER • VICTORY TECHNOLOGY ABADI • ALVA MEDIA COMPUTINDO

## JAYAPURA

DUNIA KOMPUTER • MASTER KOMPUTER • RINOKOM

# EPSON AUTHORISED DEALER

## JEMBER

BITCOM • DUTA SAMUDRA PASIFIK (IT SMART) • EANG INDONESIA (ELCOM) • SENYUM MEDIA

## JEPARA

SEMARANG COMPUTER • ANAVISIA COMPUTER • SAFRI AL AMIN COMPUTER

## JOMBANG

MITRA DATA BERJAYA

## KAB. BANDUNG

CV SINAR MANDIRI SOLUTION

## KABAN JAHE

BFLEXI COMPUTER • MITRA COMPUTER

## KANDANGAN

HITRO

## KAPUAS HULU

ELGIN COMPUTER • MITRA KOMPUTER

## KARANGANYAR

CAHAYA PUTRA MANDIRI

## KARAWANG

PRIMA COMPUTER (PC) • MEGATAMA COMPUTINDO

## KAYONG UTARA

KS KOMPUTER

## KEBUMEN

UTAMA COMPUTER • VISUAL

## KEDIRI

ADI WAHANA COMPUTER • GRACIA PRIMA COMPUTER • MITRA MANDIRI KOMPUTER • RAHARJA SEJAHTERA • SUMBER TEHNIK • MAJU MAPAN ABADI (RAJA COMPUTER)

## KENDAL

AL BUMI IT STORE • KAY DIGITAL TECHNOLOGI INDONESIA

## KENDARI

37 KOMPUTER • HND COMPUTER • IT CENTER • KALAM HIDUP • KREASI COMPUTER • MENTARI COMPUTINDO • RAKA MEDIATECH

## KETAPANG

METRO COMPUTER (MC) • R COM

## KISARAN

F3I • INTAN COMPUTER

## KLATEN

AS COMPUTER • INTICOM JAYA

## KOTAMOBAGU

@COMP (ACO COMPUTER) • ADI COMPUTER • CARPER COMPUTER • RHAVA COMPUTINDO • STARINDO COMPUTAMA

## KOTAWARINGIN BARAT

ANUGRAH CIPTA MANDIRI

## KOTAWARINGIN TIMUR

PRIMA UTAMA

## KUBU RAYA

WAYCOM

## KUDUS

SINAR JAYA COMPUTER

# EPSON AUTHORISED DEALER

## KUNINGAN

ZIGMA COMPUTER

## KUPANG

CITRA UTAMA • DUTA MULTI COMPUTER • KHARISMA KOMPUTER • PERDANA GLOBALINDO • UNISTAR ELECTRONICS

## KUTA

DELTA SUKSES

## KUTACANE

CYBERTECH COMMUNICATION

## KUTAI KARTANEGARA

DUO HATI BERSAUDARA • ERICK VON GOTTLIEB COMPUTER • RE KOMPUTER / KLINIK KOMPUTER • SENTRAL KOMPUTER

## LAHAT

JEMMY COMPUTER • RAJA COMPUTER • CV. WANGI RATANA INFORMATIKA

## LAMANDAU

MY COMPUTER

## LAMONGAN

HAMBA PUTRA

## LHOKSEUMAWE

DIZONA COMPUTER • DUNIA COMPUTER • J-COM • PC COM • SIDROE KOMPUTER

## LOMBOK

KURNIA DIGITAL SOLUSINDO

## LOMBOK TIMUR

NUSA PERDANA

## LUBUK LINGGAU

DELTA • SIGMA KOMPUTER

## LUBUK PAKAM

ARTTECH KOMPUTER

## LUMAJANG

CITRA ABADI (LCC LUMAJANG) • GALAXY • ICON KOMPUTER

## Luwuk BANGGAI

GLOBAL TECH • JAYA RAYA COMP • SMART COMPUTER • MALEO KOMPUTER

## MADIUN

BIMA DIANIMAS NUSANTARA • ISTANA KOMPUTER MADIUN • MAJU HARDWARE • WIJAYATAMA

## MAGELANG

ELSON COMPUTER • EMIRATES KOMPUTER • MICRO COMPUTER • TUNGGAL OPTI PERSADA

## MAGETAN

RAPI KOMPUTER

## MAKASSAR

ALVATECH • ARIEL COMPUTER • BRAGA SADEWA (DEWA COMPUTER) • BUMI MAKMUR KOMPUTER • CAHAYA INDOKOM • CAHAYA SURYA KOMPUTER • CAKRAWALA MEDIATECH • CELEBES CEMERLANG INDONESIA • E;EXTRA • GENIUS COMPUTER CENTRE • HND KOMPUTAMA • INTECH COMPUTER • KEDAI COMPUTER • KEYLA WILSON ABADI • KOMET KOMPUTER • LAKSANA ELANG • LESTARI COMPUTER • MAKASSAR PRINT • MANAR COMPUTER • MEGARICH MITRA JAYA • MUGEN MULTI DISTRIBUSI • OPTO ELEKTRONIK • PARAMADINA • PROTON COMPUTER • RAMA PRIMAVERA • SINAR LASER KOMPUTER • SM & T COMPUTER • SMART MEDIA CEMERLANG • SONIC KOMPUTER INDONESIA • SURYA ANUGRAH KOMPUTINDO (SURYA KOMPUTER) • VENUS COMPUTER • VICTORIA • ZAQI COMPUTER

## MALANG

ART PRINT • ASA MEDIA NUSANTARA • BATU COMPUTER • GALAXY SOLUSINDO • GREEN YUFID GROUP • HARTONO 2 COMPUTER • HEXIN • IJEN KOMPUTER • IN MULTIMEDIA (TOBA KOMPUTER) • NGALAM COMPUTER • SEMESTA GROUP • VISION TECHNOLOGY • WONDER KOMPUTER

# EPSON AUTHORISED DEALER

## MALINAU

CLAVIE COMPUTER

## MAMUJU

HND MAMUJU • IFAH KOMPUTER • MAHADEWA COMPUTER MAMUJU

## MANADO

CENTRAL GAME • HARMONI SUKSES MANDIRI • INTERTECH • KENZIE COMPUTER • LEVEL COMPUTER • MEDIA PRIMA • MM STORE • ISTANA KOMPUTER • METEOR • TERMINAL KARYA MANDIRI

## MANOKWARI

GALERINDO KOMPUTAMA (ITECH) • MAKARIOS

## MATARAM

CATUR WARGA COMPUTER • DATALINK • KABAR GEMBIRA • KURNIA DIGITAL SOLUSINDO • MATRIX COMPUTER • MILLENIA COMPUTER • REVAYAH SUMBER BERKAT • SATU SATU JAYA • RINJANI MANDIRI SEJAHTERA

## MEDAN

MEDIA COM • SUPERTECH COM • THREE NINE • PT HOKI ABADI SENTOSA • ECO TECH • SIMONE COMINDO • MITRA INTERMEDIA • OK COMPUTER • CV MANDIRI SUCCESS JAYA • ZIP COMPUTER • PD CONTEC JAYA • CV SOFTCOM • MHZ COMPUTER • BENUA JAYA COMPUTER • WAROENG IT • CV HERO KOMPUTER • SURECOM • PT LOGIKREASI UTAMA • BINTANG REZEKI COMPUTER • PT MIKROTEK KOMPUTINDO • REZEKI JAYA KOMPUTER • CV ABC ASIA • CV JAYA ABADI MEGAH • PT. PRIMAJAYA MULTI TECHNOLOGY • CV CITRALOKA • PT SUMBER UTAMA NUSANTARA • MAJU JAYA COMPUTER • CV HIDUP BARU TEKNOLOGI • CV SAMA SIDE • BEST BUY COMPUTER • TOKO SUNSHINE • GEMILANG JAYA PERKASA • CV WIN DIGITAL & COMPUTER • TOKO ABADI JAYA COMPUTER • PIXELINDO REFILL CENTER • NEW DRAGON • ORBIT COMPUTER • 123 REFILL CENTRE • WIE COM • NEWTECH COMPUTER • GOLDEN DRAGON COMPUTER • BROTHERS JAYA TECHNOLOGY • CONTEC JAYA • HERO KOMPUTER (HK) • LOGIKREASI UTAMA • MANDIRI SUCCESS JAYA • MIKROTEK KOMPUTINDO • CV SIMONE COMINDO • WIN DIGITAL & COMPUTER • PT DAYA MEGA PRATAMA • PT PRIMA JAYA MULTI TECHNOLOGY

## MELAWI

KOMDISC SUKSES TEKNOLOGI

## MERAUKE

PADI COMPUTER • STARCOM

## METRO

ADA COM • INSAN MITRA TEKNOLOGI

## MEULABOH

MULTI MEDIA

## MOJOKERTO

ANTASARI COMPUTER • IT CORNER • PROFESCA COMPUTER

## MUARA BUNGO

MITRA KOMPUTER BUNGO

## NABIRE

ARYA PANDAWA

## NIAS

D COM

## PACITAN

MITRA MULYA KOMPUTER • SURYA ABADI

## PADANG

ACACIANA COMPUTER • J-BROS / SEMANGAT BERKAT JAYA • KHARISMA COMPUTER • MAX-INDO • PANEN RAYA JAYA / MAJU JAYA • ROYAL COMPUTER • VENES JAYA

## PAINAN

FITRA PRATAMA / ARYA COMPUTER

## PALANGKARAYA

LOGOS MANDIRI • UNIVERSAL CELULER COMPUTINDO

# EPSON AUTHORISED DEALER

## PALEMBANG

ZTECH COMPUTER • METROJAYA KOMPUTER • CV BOBBY PUTRA PRATAMA • DEMPO COMPUTER • PT MULTI DATA PALEMBANG (MDP) • TERRA JAYA COMPUTINDO • CV MULIA JAYA

## PALOPO

ARUNA MULTI COMPUTER • HARCO COMPUTER PALOPO • POWER COMPUTER • SINAR PRINTER • SUMBER MUSIK

## PALU

ALEXANDRIA COMPUTER • DREAM UTAMA GROUP • LAGUNA JAYA STORE • LIBRA COM • LIMA NET COMPUTER • METEOR COMPUTER • SARA COMPUTER • SHUNU COMPUTER • SINAR MAKMUR COMPUTER • SK COM

## PAMEKASAN

SARANA INTI DATA

## PANGKAL PINANG

WELL'S COMPUTER • CV DEDE COMPUTER • CV DUTA BINTANG UTAMA

## PANGKALANBUN

AE COMPUTER • SANJAYA COMPUTER • TIM COMPUTER

## PAREPARE

ANAF COMPUTER PARE PARE

## PARIAMAN

SURYA KOMPUTER

## PARIGI

PRIMA COMPUTER

## PASURUAN

ANEKA SARANA COMPUTER (ASC) • KARISMA COMPUTER

## PATI

KODOES COMPUTER

## PASANGKAYU

FANTASI JAYA ABADI

## PAYAKUMBUH

INDO BISNIS SC (INDO COMPUTER)

## PEKALONGAN

MULTINET COMPUTER • CV MITRA GROUP/MITRA KOMPUTER • SURYA COMPUTER • JAYA EMPORIUM COMMUNICATION

## PEKANBARU

CV BITCOM NUSANTARA ELEKTRONIK • CV MEGA KOMPUTAMA PERKASA • UD PROMEDIA COMPUTINDO • CV BEST COMPUTER • CV IT JAYA PRATAMA • CV JAYA MITRA ABADI • NEW EDYCOM • CV RETYAN COMPUTER • CV SEJAHTERA IT SOLUTION (BITPLUS) • CV TEKNO KOMPUTER • CV COMPUTER SQUARE • TOKO UTAMA KOMPUTER • MULTI MEDIA COMPUTER • PT TOBA MAKMUR PERKASA • IT PRO

## PEMALANG

IRAMA PUTRA MANDIRI

## PEMATANGSIANTAR

GABE INDO PERKASA • KRAKATAU JAYA • SHINE COMPUTER

## PIDIE

ODYSSEY

## PIDIE JAYA

PRIMA JAYA

## PINRANG

LOGIKA COMPUTER • MANRAPI COMPUTER

## POLEWALI MANDAR

GALERY COMPUTER • KARTIKA CELL & COM



# EPSON AUTHORISED DEALER

## PONOROGO

GLOBAL COMPUTER • REVOLUTION PRATAMA

## PONTIANAK

ANEKA MULTI SUKSES ABADI • CIPTA MULTI JASA • CIPTA SARANA INTEGRASI • COMCOW CENTRANUSA • DATA BASIS TECHNOLOGY • DATACOM DIGITAL • DUTA COMPUTER • ERA MANDIRI • GLOBAL COMPUTER (GCOM) • KURA KOMPUTINDO (KURAKOM) • MENARA SQUARE • METRO COMPUTER • OMEGA • PONTICOM (PARIS COMPUTER) • SAHARA COMPUTER • USAHA JAYA • VIRCOM • ZOOM PERMATA (ZOOM COMPUTER) • MENARA GRUP • JAWARA COMPUTER

## PRABUMULIH

CV PRABU KOMPUTER • MSI COMPUTER

## PRINGSEWU

GLOBAL COMPUTER

## PROBOLINGGO

BARAKAT TECH • MEDIA TEHNIK COMPUTINDO • RINJAYA ELECTRINDO • SAHABAT COMPUTER • WIJAYA COMPUTER

## PURBALINGGA

TOP ONE CELL & COMPUTER

## PURWAKARTA

FASTABIC

## PURWOKERTO

TRIPHO COMPUTER (TC) • DEPO PELITA • INDO KOMPUTER (CV SISWOYO) • AXIA COMPUTER • KREASI MANDIRI / MADYA KOMPUTER

## PURWOREJO

MEDIA TEKNOLOGI

## RAHA

RC COMPUTER • RADJA COMPUTER

## RENGAT

X2 COMPUTER

## ROKAN HILIR

BAGAN SINEMBAH COMPUTER

## SALATIGA

ASTON PRINTER INDONESIA • EXA COMPUTER • MULTI JAYA TEKNIK

## SAMARINDA

ARINGO COMPUTER • BAZZAR COMPUTER • BINTANG JAYA KOMPUTER • CENTRAL JAYA COMPUTER • DJONIE PRINT • DUTA SARANA COMPUTINDO • ERO INK • HARTORA KANONDATIM PRADANA • JAYA BERSAMA • LIDATA COMPUTER • MASTER PIECE COMPUTER • MITRA JAYA MANDIRI • MULAWARMAN • PERDANA JAYA COMPUTER • PREGA LESTARI • SALIM SURYA PHONE • SMART • VIVERA • JAVA COMPUTER

## SAMBAS

MEDIA KOMPUTER • PEDOMAN COMPUTER

## SAMPIT

DATA MENTAYA • TECHNOLOGY DUNIA SATU KELUARGA (MY DIGITAL)

## SANGGAU

KINGDOM COMPUTER • ZOOM

## SAROLANGUN

DOKTER KOMPUTER

## SEKADAU

NEO COMPUTER • NEW GLORIA COMPUTER

## SEMARANG

RATU MAS PRINTER • NASIONAL COMPUTER • DUNIA LAPTOP • TOP ERLANGGA • GRAFITI PRINT SYSTEM • HANSCOM • HARISMA PRATAMA JAYA • HETERO COMPUTER • INFOKOM PUTRA KENCANA • PIXEL INKJET SOLUTION • RAJA INK SEMARANG • SELARAS MITRA SEJATI • YESTOYA ABADI • TRINITY GROUP

# EPSON AUTHORISED DEALER

## SENGKANG

ARIEL IT COMPUTER • MASTER COMPUTER SENKANG

## SERANG

BERKAH JAYA COMPUTINDO • VIA COM

## SERPONG

MITRA SUKSES MANDIRI

## SIBOLGA

MATAHARI COMPUTER • MODERN COMPUTER

## SIDOARJO

INTERMEDIA COMPUTER SOLUTION • MATAHARI MAKMUR • GLOBAL AMALIA PRATAMA • USAHA BERSAMA

## SIGLI

MARYSA COM • ORION COMPUTER

## SINGKAWANG

CENTRAL KOM

## SINJAI

AMALIA UTAMA • MULTI TEKNIK COMPUTAMA

## SINTANG

GLORIA COMPUTER • SAINTS COMPUTER

## SITUBONDO

KAIROS COMPUTER • SIGIT COMPUTER • SITCOMP

## SLEMAN

DOT PRINT

## SOLO

ANDALAS SURYA GEMILANG • SADAR JAYA MANDIRI • TUNAS ORCHID PRATAMA

## SOPPENG

MENTARI COMPUTER

## SORONG

AORA COMPUTER • MAHADEWA COMPUTER SORONG • TOHO KOMPUTER

## STABAT

VISTA COMPUTER (VC) • PUTRI COMPUTER

## SUBANG

MS COMPUTER • RUMAH TINTA

## SUKABUMI

RNY COMPUTER

## SUKAMARA

SAHABAT KOMPUTER & ELEKTRONIK

## SUMBAWA BESAR

RISKY MEDIA COMPUTER

## SUMEDANG

MITRA MANDIRI

## SURABAYA

ACK EPSON STORE • APEL COMPUTER • AIRMAS TEKNOLOGI GROSIRIA • ANUGRAH TUMBUH KHARUNIA • ARRABON COMPUTER • ASTRO KOMPUTER • ASTROTECH • BERKAT ABADI COMPUTINDO / ATC COM • CAHAYA INTI PRIMA • DATABARU COMPUTER • EPSON GALLERY • GAJAH MADA • GALA KOMPUTER • GLODOK JAYA MAKMUR • GOLD INK CENTER • INDOCOM SUKSES MAKMUR • IMPERIAL KOMPUTER • INDOTRACO • K-GALAXY • LEGENDA • LOGIDATA • MARKAS PRINTER.COM • MODERN COMPUTER • MY TECH • MYTHOS COMPUTER • NAGA JAYA COMPUTER • NUSAJAYA SEJAHTERA COMPUTER • PLASA COMPUTER • PLATINUM COLOUR • PUTRO JOYO • SAHABAT JAYA KOMPUTER • SEVEN INK • SKY PRINTING • SMART MEDIA COMPUTER • SURYA ARTHA KOMPUTAMA • SURYA CAKRA • SURYA FIRSTCOMP • SURYA LESTARI COMPUTER • SURYA WIJAYA COMPUTINDO • SURYA WINCOM • TRIJAYA COMPUTAMA • YABES PRINTER • YUTAKA COM • SURYA SAKTI TEKNOLOGI INDONESIA • SEMBILAN TEKNOLOGI • MIXITECH GRAHA TEKNIK • NIKMAT KARYA PERSADA • DWI JAYA TEKNOLOGI

# EPSON AUTHORISED DEALER

## **SURAKARTA**

MANXI IMAGE PERKASA • PRIMA MITRA ABADI • RISC COMPUTER

## **TAKENGON**

MVP KOMPUTER

## **TANGERANG**

DATA PROTECH • MITRA MARGA SEJAHTERA (MMS) • PENGUIN COMPUTER / HARTA JAYA SENTOSA BERSAUDARA • CV MITRA SUKSES MANDIRI • PT THEA THEO STATIONARY • MAJU JAYA ABADI

## **TANJUNG BALAI KARIMUN**

TECHNO INFINITY

## **TANJUNG MORAWA**

BINTANG TEKNOLOGI SEMPURNA

## **TANJUNG PANDAN**

CV MULIA JAYA

## **TANJUNG PINANG**

FORCE KOMPUTER • INFOTECH COMPUTER

## **TARAKAN**

ADIN PRINTER • PLUS-PLUS • SELECTA STATIONERY

## **TASIKMALAYA**

PLANET COMPUTER

## **TEBING TINGGI**

MITRA UTAMA COMPUTER • PEGASUS COMPUTER • ALPHA COMPUTER

## **TEGAL**

TWININDO COMPUTECH • GRAHA COMPUTER • PUTRAPUTRA LANGGENG JAYA • CV INDO KOMPUTER • CV NEW LIFE COMPUTER

## **TEMBILAHAN**

TOKO NORMAL • EDY COMPUTER • MATRIX PERKASA

## **TERNATE**

DATAGRID MAESTRO TEKNO • GIGA COM • MARS JAYA

## **TIMIKA**

GALILEA KOMPUTER • GENESIS COMPUTER • INDOPRIMA JAYA • ITHSAN INFOTIKA

## **TORAJA**

BALBOD COMPUTER • MULTICOM ANUGRAH PERSADA • SHELL COMPUTER

## **TUBAN**

MITRA SEJATI KOMPUTER • VICTORY INDO PRATAMA (VICTORY COMPUTER)

## **TULUNGAGUNG**

HARAPAN INDO SENTOSA (ONE CENTRAL PRINTER) • MAXINDO COMPUTER • RADJA COMPUTER • SAMODRA LANGGENG LESTARI SANTOSO

## **WAINGAPU**

GLOBAL TEKNIK

## **WONOGIRI**

RAYA SOLUSINDO • RELASI MADANI (ANISAH COMPUTER)

## **WONOSOBO**

JUZZI COMPUTER • CV HUSNA COMPUTER

## **YOGYAKARTA**

AIZZA • ANNISA COMPUTER • BELLA COMPUTER • BERKAH SEMESTA ALAM (FASTA COMPUTER) • CENTRO INK • CHANNEL COMPUTER • FAHANA CITRA (EVER TECH) • HARRISMA BUWANA JAYA • J KOMPUTER • JAYA UTAMA SUKSES • JOY PRINT SOLUTION • KANA • LOGISHOP JOGJAKARTA • MEDIA PERSADA COMPUTINDO • PERSONAL • PRIMA COMPUTER • PRINTECH • RAJA INK YOGYAKARTA • RUMAH KOMPUTER • SETIA HARAPAN COMPUTER • SUKSES SEJATI COMPUTAMA • STAR MEDIA COMPUTAMA • SEMPURNA SEJAHTERA KOMPUTINDO • BRAGA SADEWA

# INKTANK PRINTER



# INKTANK PRINTER

## MENGAPA MEMILIH ECOTANK ?

*Printhead* seri EcoTank dengan teknologi *Micro Piezo* merupakan teknologi eksklusif dari Epson. Dirancang bekerja andal dan tahan lama. *Printhead Micro Piezo* memungkinkan pencetakan pada berbagai jenis media. Adapula fitur cetak cepat, pemrosesan gambar, sistem tinta, tinta, pemindahan kertas dengan sangat akurat dan mekanisme lainnya.

### PrecisionCore

*PrecisionCore* adalah teknologi printhead yang berupa lapisan tipis unik *piezo* (TFP) yang memadukan teknologi komponen superior dengan teknologi fabrikasi *Micro-Electro-Mechanical-System (MEMS)* yang berpresisi tinggi. Hasilnya adalah kecepatan cetak dan mutu gambar yang tinggi untuk pemakaian di berbagai kegiatan usaha dan industri.

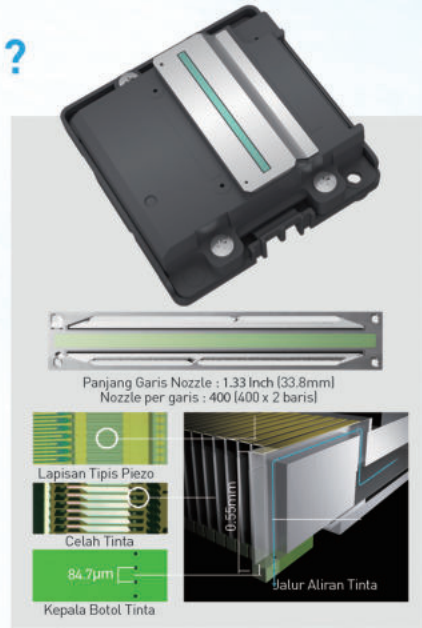

## BOTOL TINTA UNIK YANG DAPAT BERHENTI OTOMATIS DAN TANGKI TINTA MUDAH DIISI ULANG



Tangki tinta menghadap ke depan untuk mempermudah pengisian ulang tinta.



Tidak akan ada kesalahan pengisian ulang tinta karena setiap desain saluran memiliki bentuk berbeda.



Tidak tumpah.

# INKTANK PRINTER

## Printer Warna Printer Multifungsi untuk Perkantoran / SOHO

INKTANK PRINTER



### L6290



- Printer Type** Print, Scan, Copy, Fax with ADF
- Technology** PrecisionCore™ Printhead
- Ink** 4 Colours Epson Genuine Ink Bottle
- Print Resolution** 4,800 x 1,200 dpi (with Variable-Sized Droplet Technology)
- Print Speed** Up to 33 ppm / 20 ppm
- Copy Resolution** 600 x 600 dpi
- Copy Speed** Up to 11 ipm / 5.5 ppm
- Scan Resolution** 1,200 x 2,400 dpi
- Scan Speed** Monochrome 200 dpi: 12 sec, ADF ; 5.0 ipm  
Colour 200 dpi: 27 sec, ADF ; 5.0 ipm
- Connectivity** USB 2.0, Ethernet, Wi-Fi IEEE 802.11b/g/n, Wi-Fi Direct
- Epson Connect** Epson iPrint, Email Print, Remote Print Driver, Scan to Cloud
- Other Mobile Solution** Apple AirPrint, Mopria Print Service, Epson Smart Panel
- Warranty Ink Model** 2 years or 50,000 pages 001



### L6270



- Printer Type** Print, Scan, Copy with ADF
- Technology** PrecisionCore™ Printhead
- Ink** 4 Colours Epson Genuine Ink Bottle
- Print Resolution** 4,800 x 1,200 dpi (with Variable-Sized Droplet Technology)
- Print Speed** Up to 33 ppm / 20 ppm
- Copy Resolution** 600 x 600 dpi
- Copy Speed** Up to 11 ipm / 5.5 ppm
- Scan Resolution** 1,200 x 2,400 dpi
- Scan Speed** Monochrome 200 dpi - Flatbed : 12 sec / ADF ; 5.0 ipm  
Colour 200 dpi - Flatbed : 27 sec, ADF ; 5.0 ipm
- Connectivity** USB 2.0, Ethernet, Wi-Fi IEEE 802.11b/g/n, Wi-Fi Direct
- Epson Connect** Epson iPrint, Email Print, Remote Print Driver, Scan to Cloud
- Other Mobile Solution** Apple AirPrint, Mopria Print Service, Epson Smart Panel
- Warranty Ink Model** 2 years or 50,000 pages 001

# INKTANK PRINTER

## Printer Warna Printer Multifungsi untuk Perkantoran / SOHO

### L6260

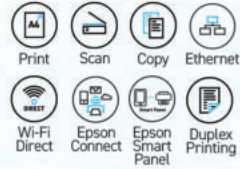

- Printer Type** Print, Scan, Copy
- Technology** PrecisionCore™ Printhead
- Ink** 4 Colours Epson Genuine Ink Bottle
- Print Resolution** 4,800 x 1,200 dpi (with Variable-Sized Droplet Technology)
- Print Speed** Up to 33 ppm / 20 ppm
- Copy Resolution** 600 x 600 dpi
- Copy Speed** Up to 11 ipm / 5.5 ppm
- Scan Resolution** 1,200 x 2,400 dpi
- Scan Speed** Monochrome 200 dpi: 12 sec  
Colour 200 dpi: 27 sec
- Connectivity** USB 2.0, Ethernet, Wi-Fi IEEE 802.11b/g/n, Wi-Fi Direct
- Epson Connect** Epson iPrint, Email Print, Remote Print Driver, Scan to Cloud
- Other Mobile Solution** Apple AirPrint, Mopria Print Service, Epson Smart Panel
- Warranty** 2 years or 50,000 pages
- Ink Model** 001

### L5290



- Printer Type** Print, Scan, Copy, Fax with ADF
- Technology** On Demand Inkjet (Piezoelectric)
- Ink** 4 Colours Epson Genuine Ink Bottle
- Print Resolution** 5,760 x 1,440 dpi (with Variable-Sized Droplet Technology)
- Print Speed** Approx. 33 ppm / 15 ppm
- Copy Resolution** 600 x 600 dpi
- Copy Speed** Up to 7.7 ipm / 3.8 ipm
- Scan Resolution** 1,200 x 2,400 dpi
- Scan Speed** Monochrome - Flatbed : 12 sec / ADF : 4.5 ipm  
Colour - Flatbed : 29 sec / ADF : 4.5 ipm
- Connectivity** USB 2.0, Ethernet, Wi-Fi IEEE 802.11b/g/n, Wi-Fi Direct
- Epson Connect** Epson iPrint, Epson Email Print, Remote Print Driver
- Other Mobile Solution** Apple AirPrint, Mopria Print Service, Epson Smart Panel
- Warranty** 2 years or 30,000 pages
- Ink Model** 003

# INKTANK PRINTER

## Printer Warna Printer Multifungsi untuk Perkantoran / SOHO

INKTANK PRINTER



### L5590



- Printer Type** Print, Scan, Copy, Fax with ADF
- Technology** PrecisionCore Printhead
- Ink** 4 Colours Epson Genuine Ink Bottle
- Print Resolution** 4800 x 1200 dpi  
(with Variable-Sized Droplet Technology)
- Print Speed** up to 33 ppm / 20 ppm
- Copy Resolution** 600 x 600 dpi
- Copy Speed** up to 10.8 ipm / 5.5 ipm
- Scan Resolution** 1,200 x 2,400 dpi
- Scan Speed** Monochrome 200 dpi - 12 sec / 5.0 ipm  
Colour 200 dpi - 29 sec / 5.0 ipm
- Connectivity** USB 2.0, Ethernet, Wi-Fi IEEE 802.11b/g/n, Wi-Fi Direct
- Epson Connect** Epson iPrint, Epson Email Print, Remote Print Driver
- Other Mobile Solution** Apple AirPrint, Mopria Print Service, Epson Smart Panel
- Warranty Ink Model** 2 years or 50,000 pages 003

### L4260

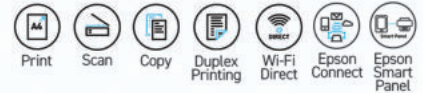

- Printer Type** Print, Scan, Copy
- Technology** On Demand Inkjet (Piezoelectric)
- Ink** 4 Colours Epson Genuine Ink Bottle
- Print Resolution** 5,760 x 1,440 dpi  
(with Variable-Sized Droplet Technology)
- Print Speed** Up to 33 ppm / 15 ppm
- Copy Resolution** 600 x 600 dpi
- Copy Speed** Up to 7.7 ipm / 3.8 ppm
- Scan Resolution** 1,200 x 2,400 dpi
- Scan Speed** Monochrome 200 dpi: 11 sec  
Colour 200 dpi: 28 sec
- Connectivity** USB 2.0, Wi-Fi IEEE 802.11b/g/n, Wi-Fi Direct
- Epson Connect** Epson iPrint, Epson Email Print, Remote Print Driver
- Other Mobile Solution** Apple AirPrint, Mopria Print Service, Epson Smart Panel
- Warranty Ink Model** 2 years or 30,000 pages 001



# INKTANK PRINTER

## Printer Warna Printer Multifungsi untuk Perkantoran / SOHO



### L6460



- Printer Type** Print, Scan, Copy with ADF
- Technology** PrecisionCore™ Printhead
- Ink** 4 colours pigment Epson Genuine Ink Bottle
- Print Resolution** 4,800 x 1,200 dpi (with Variable-Sized Droplet Technology)
- Print Speed** Up to 37 ppm / 23 ppm
- Copy Resolution** 600 x 600 dpi
- Copy Speed** Up to 12 ipm / 6 ppm
- Scan Resolution** 1,200 x 2,400 dpi
- Scan Speed** Monochrome 200 dpi: Flatbed 12 ipm / 6 ipm, ADF ; 10 ipm/5 ipm  
Colour 200 dpi: 27 sec, ADF : 5 ipm
- Connectivity** USB 2.0, Ethernet, Wi-Fi IEEE 802.11b/g/n, Wi-Fi Direct
- Epson Connect** Epson iPrint, Email Print, Remote Print Driver, Scan to Cloud
- Other Mobile Solution** Apple AirPrint, Mopria Print Service, Epson Smart Panel
- Warranty Ink Model** 2 years or 50,000 pages 008

### L6490

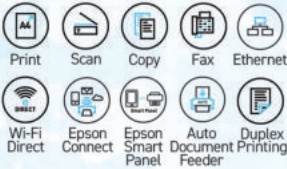

- Printer Type** Print, Scan, Copy, Fax with ADF
- Technology** PrecisionCore™ Printhead
- Ink** 4 colours pigment Epson Genuine Ink Bottle
- Print Resolution** 4,800 x 1,200 dpi (with Variable-Sized Droplet Technology)
- Print Speed** Up to 37 ppm / 23 ppm
- Copy Resolution** 600 x 600 dpi
- Copy Speed** Up to 12 ipm / 6 ppm
- Scan Resolution** 1,200 x 2,400 dpi
- Scan Speed** Monochrome 200 dpi: Flatbed 12 ipm / 6 ipm, ADF ; 10 ipm/5 ipm  
Colour 200 dpi: 27 sec, ADF : 5 ipm
- Connectivity** USB 2.0, Ethernet, Wi-Fi IEEE 802.11b/g/n, Wi-Fi Direct
- Epson Connect** Epson iPrint, Email Print, Remote Print Driver, Scan to Cloud
- Other Mobile Solution** Apple AirPrint, Mopria Print Service, Epson Smart Panel
- Warranty Ink Model** 2 years or 50,000 pages 008

# INKTANK PRINTER

## Printer Warna Printer Multifungsi untuk Perkantoran / SOHO

### L14150



- Printer Type** Print, Scan, Copy, Fax with ADF
- Technology** PrecisionCore™ Printhead
- Ink** 4 Colours Epson Genuine Ink Bottle
- Print Resolution** 4,800 x 1,200 dpi
- Print Speed** Up to 38 ppm / 24 ppm
- Copy Resolution** 600 x 600 dpi
- Copy Speed** Up to 11.5 ipm / 5.5 ipm
- Scan Resolution** 1,200 x 2,400 dpi
- Scan Speed** monochrome, 200 dpi; Flatbed : 13 sec / ADF : 5 ipm
- Connectivity** Color, 200 dpi; Flatbed : 28 sec / ADF : 5 ipm
- Epson Connect** USB 2.0, Ethernet, Wi-Fi IEEE 802.11b/g/n, Wi-Fi Direct
- Other Mobile Solution** Epson iPrint, Epson Email Print, Remote Print Driver, Scan to Cloud
- Warranty Ink Model** Apple AirPrint, Mopria Print Service, Epson Smart Panel
- 2 years or 80,000 pages
- 001

### L15150



- Printer Type** Print, Scan, Copy, Fax with ADF
- Technology** PrecisionCore™ Printhead
- Ink** 4 Colours Epson Genuine Ink Bottle
- Print Resolution** 4800 x 2400 dpi (with Variable-sized Droplet Technology)
- Print Speed** Approx; 32.0 ppm / 22.0 ppm
- Copy Resolution** 600 x 600 dpi
- Copy Speed** 23.0 ipm / 10.0 ipm
- Scan Resolution** 1200 x 2400 dpi
- Scan Speed** Black 200 dpi : Flatbed : 5 sec / ADF (Simplex / Duplex) : 26.0 ipm / 11.5 ipm
- Connectivity** Colour 200 dpi : Flatbed : 10 sec / ADF (Simplex / Duplex) : 9.0 ipm / 6.0 ipm
- Epson Connect** USB 2.0 Hi-speed, Ethernet, Wi-Fi IEEE 802.11b/g/n, Wi-Fi Direct
- Other Mobile Solutions** Epson iPrint, Email Print, Remote Print Driver, Scan to Cloud
- Warranty Ink Model** Apple AirPrint, Mopria Print Service, Epson Smart Panel
- 2 years or 80.000 pages
- 008

# INKTANK PRINTER

## Printer Warna Printer Multifungsi untuk SOHO / Rumah

### L3250



- Printer Type: Print, Scan, Copy
- Technology: On Demand Inkjet (Piezoelectric)
- Ink: 4 Colours Epson Genuine Ink Bottle
- Print Resolution: 5,760 x 1,440 dpi (with Variable-Sized Droplet Technology)
- Print Speed: Approx. 33 ppm / 15 ppm
- Copy Resolution: 600 x 600 dpi
- Copy Speed: Up to 7.0 ipm / 1.7 ipm
- Scan Resolution: 1200 x 2400 dpi
- Scan Speed: Monochrome 200 dpi: 11 sec  
Colour 200 dpi: 28 sec
- Connectivity: USB 2.0, Wi-Fi, Wi-Fi Direct
- Epson Connect: Epson iPrint, Epson Email Print, Remote Print Driver
- Epson Smart Panel: Epson Smart Panel
- Warranty: 2 years or 30,000 pages
- Ink Model: 003

Other Mobile Solution  
Warranty  
Ink Model

### L3550



- Printer Type: Print, Scan, Copy
- Technology: PrecisionCore Printhead
- Ink: 4 Colours Epson Genuine Ink Bottle
- Print Resolution: 4,800 x 1,200 dpi (with Variable-Sized Droplet Technology)
- Print Speed: up to 33 ppm / 20 ppm
- Copy Resolution: 600 x 600 dpi
- Copy Speed: up to 10.8 ipm / 5.5 ipm
- Scan Resolution: 1200 x 2400 dpi
- Scan Speed: Monochrome 200 dpi: 11 sec  
Colour 200 dpi: 28 sec
- Connectivity: USB 2.0, Wi-Fi IEEE 802.11b/g/n, Wi-Fi Direct
- Epson Connect: Epson iPrint, Epson Email Print, Remote Print Driver
- Epson Smart Panel: Apple AirPrint, Mopria Print Service, Epson Smart Panel
- Warranty: 2 years or 50,000 pages
- Ink Model: 003

Other Mobile Solution  
Warranty  
Ink Model

### L3210

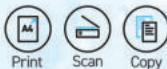

- Printer Type: Print, Scan, Copy
- Technology: On Demand Inkjet (Piezoelectric)
- Ink: 4 Colours Epson Genuine Ink Bottle
- Print Resolution: 5,760 x 1,440 dpi (with Variable-Sized Droplet Technology)
- Print Speed: Approx. 33 ppm / 15 ppm
- Copy Resolution: 600 x 600 dpi
- Copy Speed: Up to 7.0 ipm / 1.7 ipm
- Scan Resolution: 600 x 1,200 dpi
- Scan Speed: Monochrome 200 dpi: 11 sec  
Colour 200 dpi: 32 sec
- Connectivity: USB 2.0 Hi-speed
- Warranty: 2 years or 30,000 pages
- Ink Model: 003

Other Mobile Solution  
Warranty  
Ink Model

# INKTANK PRINTER

Printer Warna  
Printer Foto

INKTANK PRINTER



## L8050



- Printer Type** Print
- Technology** On Demand Inkjet (Piezoelectric)
- Ink** 6 Colours Epson Genuine Ink Bottle
- Print Resolution** 5,760 x 1,440 dpi (with Variable-Sized Droplet Technology)
- Print Speed** up to 22 ppm / 22 ppm
- Connectivity** USB 2.0, Wi-Fi IEEE 802.11b/g/n, Wi-Fi Direct
- Epson Connect** Epson iPrint, Epson Email Print, Remote Print Driver
- Other Mobile Solution** Epson Smart Panel
- Warranty** 2 years or 50,000 pages
- Ink Model** 057



## L850



- Printer Type** Print, Scan, Copy
- Technology** On Demand Inkjet (Piezoelectric)
- Ink** 6 Colours Epson Genuine Ink Bottle
- Print Resolution** 5,760 x 1,440 dpi (with Variable-Sized Droplet Technology)
- Print Speed** Approx. 37 ppm / 38 ppm
- Copy Resolution** N/A
- Copy Speed** Approx 37 cpm / 38 cpm
- Scan Resolution** 1,200 x 2,400 dpi
- Scan Speed** Monochrome 300 dpi : 1,6 msec/line  
Colour 300 dpi : 4,6 msec/line
- Connectivity** USB 2.0 Hi-speed
- Warranty** 1 year or 3,000 photo prints
- Ink Model** 673

# INKTANK PRINTER

Printer Warna  
Printer Foto

NEW  
PRODUCT



## L18050



Printer Type	Print - A3 Size
Technology	On Demand Inkjet (Piezoelectric)
Ink	6 Colours Epson Genuine Ink Bottle
Print Resolution	5,760 x 1,440 dpi (with Variable-Sized Droplet Technology)
Print Speed	up to 22 ppm / 22 ppm
Connectivity	USB 2.0, Wi-Fi IEEE 802.11b/g/n, Wi-Fi Direct
Epson Connect	Epson iPrint, Epson Email Print, Remote Print Driver
Other Mobile Solution	Epson Smart Panel
Warranty	2 years or 50,000 pages
Ink Model	057

Printer Warna  
Printer Fungsi Tunggal untuk SOHO / Rumah



## L121



Print	Print
Printer Type	Print
Technology	on Demand inkjet (piezoelectric)
Ink	4 Colours Epson Genuine Ink Bottle
Print Resolution	720 x 720 dpi (with Variable-Sized Droplet Technology)
Print Speed	up to 9.0 ipm / 4.8 ipm
Connectivity	USB 2.0 Hi-speed
Warranty	2 years or 20,000 pages
Ink Model	664

# INKTANK PRINTER

Printer Warna  
Printer Fungsi Tunggal untuk SOHO / Rumah

INKTANK PRINTER

## L1210



Print



Printer Type	Print
Technology	on Demand inkjet (piezoelectric)
Ink	4 Colours Epson Genuine Ink Bottle
Print Resolution	5760 x 1440 dpi (with Variable-Sized Droplet Technology)
Print Speed	up to 33.0 ppm / 15.0 ppm
Connectivity	USB 2.0 Hi-speed
Warranty	2 Years or 30,000 pages
Ink Model	003

## L1250



Print



Wi-Fi Direct



Epson Connect



Epson Smart Panel



Printer Type	Print
Technology	on Demand inkjet (piezoelectric)
Ink	4 Colours Epson Genuine Ink Bottle
Print Resolution	5760 x 1440 dpi (with Variable-Sized Droplet Technology)
Print Speed	up to 33.0 ppm / 15.0 ppm
Connectivity	USB 2.0, Wi-Fi, Wi-Fi Direct
Epson Connect	Epson iPrint, Epson Email Print, Remote Print Driver
Other Mobile Solution	Epson Smart Panel
Warranty	2 Years or 30,000 pages
Ink Model	003

# INKTANK PRINTER

Printer Warna  
Printer Fungsi Tunggal untuk SOHO / Rumah



## L1300



Print (A3+)

Printer Type	Print - A3 Size
Technology	On Demand Inkjet (Piezoelectric)
Ink	4 Colours Epson Genuine Ink Bottle
Print Resolution	5,760 x 1,440 dpi (with Variable-Sized Droplet Technology)
Print Speed	Approx. 30 ppm / 17 ppm
Connectivity	USB 2.0 Hi-speed
Warranty	2 years or 30,000 pages
Ink Model	664

## Inkjet Portable Printer

### WORKFORCE PRO WF-100



Print



Wi-Fi Direct



Epson Connect



Epson Smart Panel



Print Tech	Micro Piezo™ Printhead
Print Type	Print (Single Function)
Print Resolution	5,760 x 1,440 dpi (with Variable-Sized Droplet Technology)
Print Speed	Draft, A4 (Black / Colour): Up to 14 ppm / 11 ppm ISO 24734, A4 Simplex (Black / Colour): Up to 7.0 ipm / 4.0 ipm
Paper Size	Legal, Letter, A4, B5, A5, A6, 8x10", 5x7", 4x6", Envelopes: #10, DL, C6
Power Consumption	Operating: Approx 11 W Standby: Approx 4.0 W Sleep: Approx 1.3 W
Connectivity	Hi-Speed USB 2.0, Wi-Fi (IEEE 802.11b/g/n) Wi-Fi Direct
Epson Connect	Epson iPrint, Epson Email Print, Remote Print Driver, Epson Creative Print
Other Mobile Solutions	Apple AirPrint, Google Cloud Print, Mopria Print Service
Consumable	Up to 250 pages* for black ink pack (T289BK) & 200 pages* for color ink pack (T290CL)

# INKTANK PRINTER

Printer Monokrom  
Printer Multifungsi untuk Perkantoran / SOHO

INKTANK PRINTER

## M3170



- Printer Type** Print, Scan, Copy, Fax with ADF  
**Technology** PrecisionCore™ Printhead  
**Ink** Black Pigment Epson genuine Ink Bottle  
**Print Resolution** 1,200 x 2,400 dpi  
(with Variable-Sized Droplet Technology)  
**Print Speed** Up to 39 ppm  
**Copy Speed** Up to 17 ipm  
**Scan Resolution** 1,200 x 2,400 dpi  
**Scan Speed** Monochrome 200 dpi: 12 sec  
Colour 200 dpi: 27 sec  
**Connectivity** USB 2.0 Hi-speed, Ethernet, Wi-Fi IEEE  
802.11b/g/n, Wi-Fi Direct  
**Epson Connect** Epson iPrint, Email Print, Remote Print Driver,  
Scan to Cloud  
**Other Mobile Solution** Apple AirPrint, Google Cloud Print, Morpria Print  
Service  
**Warranty** 4 years or 50,000 pages  
**Ink Model** 005

## M2140

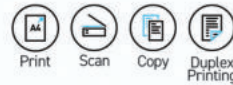

- Printer Type** Print, Scan, Copy  
**Technology** PrecisionCore™ Printhead  
**Ink** Black Pigment Epson genuine Ink Bottle  
**Print Resolution** 1,200 x 2,400 dpi  
(with Variable-Sized Droplet Technology)  
**Print Speed** Up to 39 ppm  
**Copy Resolution** 600 x 600 dpi  
**Copy Speed** Up to 17 ipm  
**Scan Resolution** 1,200 x 2,400 dpi  
**Scan Speed** Monochrome 200 dpi: 12 sec  
Colour 200 dpi: 27 sec  
**Connectivity** USB 2.0 Hi-speed  
**Warranty** 4 years or 50,000 pages  
**Ink Model** 005



# INKTANK PRINTER

Printer Monokrom  
Printer Multifungsi untuk Perkantoran / SOHO

## M15140



- Printer Type** Print, Scan, Copy, ADF  
**Technology** PrecisionCore™ Printhead  
**Ink** Black Pigment Epson genuine Ink Bottle  
**Print Resolution** 4800 x 2400 dpi (with Variable-sized Droplet Technology)  
**Print Speed** up to 32.0 ppm  
**Copy resolution** 600 x 600 dpi  
**Copy speed** up to 23.0 ipm  
**Scan Resolution** 1200 x 2400 dpi  
**Scan Speed** Black 200 dpi : Flatbed : 5 sec / ADF (Simplex / Duplex) : 26.0 ipm / 11.5 ipm  
**Connectivity** USB 2.0, Ethernet, Wi-Fi IEEE 802.11b/g/n, Wi-Fi Direct  
**Epson Connect** Epson iPrint, Epson Email Print, Remote Print Driver, Scan to Cloud  
**Other Mobile Solution** Apple AirPrint, Mopria Print Service, Smart Panel  
**Warranty** 4 years or 150,000 pages  
**Ink Model** 008

## M2170



- Printer Type** Print, Scan, Copy  
**Technology** PrecisionCore™ Printhead  
**Ink** Black Pigment Epson genuine Ink Bottle  
**Print Resolution** 1,200 x 2,400 dpi (with Variable-Sized Droplet Technology)  
**Print Speed** Up to 39 ppm  
**Copy Resolution** 600 x 600 dpi  
**Copy Speed** Simplex: Up to 17.0 ipm  
**Scan Resolution** 1,200 x 2,400 dpi  
**Scan Speed** Monochrome 200 dpi: 12 sec  
Colour 200 dpi: 27 sec  
**Connectivity** USB 2.0, Wi-Fi IEEE 802.11b/g/n, Wi-Fi Direct, Ethernet  
**Epson Connect** Epson iPrint, Epson Email Print, Remote Print Driver  
**Other Mobile Solution** Apple AirPrint, Mopria Print Service  
**Warranty** 4 years or 50,000 pages  
**Ink Model** 005

# INKTANK PRINTER

Printer Monokrom  
Printer Fungsi Tunggal untuk Perkantoran / SOHO / Rumah

## M1140



Printer Type	Print
Technology	PrecisionCore™ Printhead
Ink	Black Pigment Epson genuine Ink Bottle
Print Resolution	1,200 x 2,400 dpi (with Variable-Sized Droplet Technology)
Print Speed	Up to 39 ppm
Connectivity	USB 2.0 Hi-speed
Warranty	4 Years or 50,000 pages
Ink Model	005

## M1120



Printer Type	Print
Technology	On Demand Inkjet (Piezoelectric)
Ink	Black Pigment Epson genuine Ink Bottle
Print Resolution	1,440 x 720 dpi (with Variable-Sized Droplet Technology)
Print Speed	Up to 32 ppm
Connectivity	USB 2.0 Hi-speed, Wi-Fi IEEE 802.11b/g/n, Wi-Fi Direct
Epson Connect	Epson iPrint, Epson Email Print, Remote Print Driver
Other Mobile Solution	Google Cloud Print
Warranty	4 years or 50,000 pages
Ink Model	005

# INKTANK PRINTER

Printer Monokrom  
Printer Fungsi Tunggal untuk Perkantoran / SOHO / Rumah



## M1100



Printer Type	Print
Technology	On Demand Inkjet (Piezoelectric)
Ink	Black Pigment Epson genuine Ink Bottle
Print Resolution	1,440 x 720 dpi (with Variable-Sized Droplet Technology)
Print Speed	Up to 32 ppm
Connectivity	USB 2.0 Hi-speed
Warranty	4 years or 50,000 pages
Ink Model	005



## M1170



Printer Type	Print
Technology	PrecisionCore Printhead
Ink	Black Pigment Epson genuine Ink Bottle
Print Resolution	1,200 x 2,400 dpi (with Variable-Sized Droplet Technology)
Print Speed	up to 39 ppm
Connectivity	USB 2.0, Wi-Fi IEEE 802.11b/g/n, Wi-Fi Direct, Ethernet
Epson Connect	Epson iPrint, Epson Email Print, Remote Print Driver
Other Mobile Solution	Mopria Print Service
Warranty	4 years or 50,000 pages
Ink Model	005

# INKTANK PRINTER- 3 Years Warranty



## L1211



Print

- Printer Type** Print  
**Technology** on Demand inkjet (piezoelectric)  
**Ink** 4 Colours Epson Genuine Ink Bottle  
**Print Resolution** 5760 x 1440 dpi  
(with Variable-Sized Droplet Technology)  
**Print Speed** up to 33.0 ppm / 15.0 ppm  
**Connectivity** USB 2.0 Hi-speed  
**Warranty** **3 Years or 30,000 pages**  
**Ink Model** 003



## L1251



Print



Wi-Fi Direct



- Printer Type** Print  
**Technology** on Demand inkjet (piezoelectric)  
**Ink** 4 Colours Epson Genuine Ink Bottle  
**Print Resolution** 5760 x 1440 dpi  
(with Variable-Sized Droplet Technology)  
**Print Speed** up to 33.0 ppm / 15.0 ppm  
**Connectivity** USB 2.0 Hi Speed, Wi-Fi, Wi-Fi Direct  
**Epson Connect** Epson iPrint, Epson Email Print, Remote Print Driver  
**Other Mobile Solution** Epson Smart Panel  
**Warranty** **3 Years or 30,000 pages**  
**Ink Model** 003



## L3211



Print



Scan



Copy

- Printer Type** Print, Scan, Copy  
**Technology** On Demand Inkjet (Piezoelectric)  
**Ink** 4 Colours Epson Genuine Ink Bottle  
**Print Resolution** 5,760 x 1,440 dpi  
(with Variable-Sized Droplet Technology)  
**Print Speed** Approx. 33 ppm / 15 ppm  
**Copy Resolution** 600 x 600 dpi  
**Copy Speed** Up to 7.0 ipm / 1.7 ipm  
**Scan Resolution** 600 x 1,200 dpi  
**Scan Speed** Monochrome 200 dpi: 11 sec  
Colour 200 dpi: 32 sec  
**Connectivity** USB 2.0 Hi-speed  
**Warranty** **3 years or 30,000 pages**  
**Ink Model** 003

# INKTANK PRINTER- 3 Years Warranty



## L3251



Printer Type  
Technology  
Ink  
Print Resolution

Print, Scan, Copy  
On Demand Inkjet (Piezoelectric)  
4 Colours Epson Genuine Ink Bottle  
5,760 x 1,440 dpi  
(with Variable-Sized Droplet Technology)

Print Speed  
Copy Resolution  
Copy Speed  
Scan Resolution  
Scan Speed

Approx. 33 ppm / 15 ppm  
600 x 600 dpi  
Up to 7.7 ipm / 3.8 ipm  
1200 x 2400 dpi  
Monochrome 200 dpi: 11 sec

Connectivity  
Epson Connect

Colour 200 dpi: 28 sec  
USB 2.0, Wi-Fi, Wi-Fi Direct  
Epson iPrint, Epson Email Print,  
Remote Print Driver  
Epson Smart Panel

Other Mobile Solution  
Warranty  
Ink Model

**3 years or 30,000 pages**  
003



## L4261



Printer Type  
Technology  
Ink  
Print Resolution

Print, Scan, Copy  
On Demand Inkjet (Piezoelectric)  
4 Colours Epson Genuine Ink Bottle  
5,760 x 1,440 dpi  
(with Variable-Sized Droplet Technology)

Print Speed  
Copy Resolution  
Copy Speed  
Scan Resolution  
Scan Speed

Up to 33 ppm / 15 ppm  
600 x 600 dpi  
Up to 7.7 ipm / 3.8 ipm  
1,200 x 2,400 dpi  
Monochrome 200 dpi: 11 sec

Connectivity  
Epson Connect

Colour 200 dpi: 28 sec  
USB 2.0, Wi-Fi IEEE 802.11b/g/n,  
Wi-Fi Direct  
Epson iPrint, Epson Email Print, Remote Print  
Driver

Other Mobile Solution  
Warranty  
Ink Model

Apple AirPrint, Mopria Print Service,  
Epson Smart Panel  
**3 years or 30,000 pages**  
001

# INKTANK PRINTER (Available Only In Epson Official Store)

## L1216



**Printer Type** Print  
**Technology** on Demand inkjet (piezoelectric)  
**Ink** 4 Colours Epson Genuine Ink Bottle  
**Print Resolution** 5760 x 1440 dpi  
(with Variable-Sized Droplet Technology)  
**Print Speed** up to 33.0 ppm / 15.0 ppm  
**Connectivity** USB 2.0 Hi-speed  
**Warranty** 2 Years or 30,000 pages  
**Ink Model** 003

## L1256



**Printer Type** Print  
**Technology** on Demand inkjet (piezoelectric)  
**Ink** 4 Colours Epson Genuine Ink Bottle  
**Print Resolution** 5760 x 1440 dpi  
(with Variable-Sized Droplet Technology)  
**Print Speed** up to 33.0 ppm / 15.0 ppm  
**Connectivity** USB 2.0, Wi-Fi, Wi-Fi Direct  
**Epson Connect** Epson iPrint, Epson Email Print, Remote Print Driver  
**Other Mobile Solution** Epson Smart Panel  
**Warranty** 2 Years or 30,000 pages  
**Ink Model** 003

## L3216



**Printer Type** Print, Scan, Copy  
**Technology** On Demand Inkjet (Piezoelectric)  
**Ink** 4 Colours Epson Genuine Ink Bottle  
**Print Resolution** 5,760 x 1,440 dpi  
(with Variable-Sized Droplet Technology)  
**Print Speed** Approx. 33 ppm / 15 ppm  
**Copy Resolution** 600 x 600 dpi  
**Copy Speed** Up to 7.0 ipm / 1.7 ipm  
**Scan Resolution** 600 x 1,200 dpi  
**Scan Speed** Monochrome 200 dpi: 11 sec  
Colour 200 dpi: 32 sec  
**Connectivity** USB 2.0 Hi-speed  
**Warranty** 2 years or 30,000 pages  
**Ink Model** 003

# INKTANK PRINTER (Available Only In Epson Official Store)

## L3256



Printer Type  
Technology  
Ink  
Print Resolution

Print, Scan, Copy  
On Demand Inkjet (Piezoelectric)  
4 Colours Epson Genuine Ink Bottle  
5,760 x 1,440 dpi  
(with Variable-Sized Droplet Technology)

Print Speed  
Copy Resolution  
Copy Speed  
Scan Resolution  
Scan Speed

Approx. 33 ppm / 15 ppm  
600 x 600 dpi  
Up to 7.0 ipm / 1.7 ipm  
1200 x 2400 dpi  
Monochrome 200 dpi: 11 sec  
Colour 200 dpi: 28 sec

Connectivity  
Epson Connect

USB 2.0, Wi-Fi, Wi-Fi Direct  
Epson iPrint, Epson Email Print,  
Remote Print Driver  
Epson Smart Panel  
2 years or 30,000 pages  
003

Other Mobile Solution  
Warranty  
Ink Model

## L3556



Printer Type  
Technology  
Ink  
Print Resolution

Print, Scan, Copy  
PrecisionCore Printhead  
4 Colours Epson Genuine Ink Bottle  
4,800 x 1,200 dpi  
(with Variable-Sized Droplet Technology)

Print Speed  
Copy Resolution  
Copy Speed  
Scan Resolution  
Scan Speed

Approx. 33 ppm / 20 ppm  
600 x 600 dpi  
up to 10.8 ipm / 5.5 ipm  
1200 x 2400 dpi  
Monochrome 200 dpi: 11 sec  
Colour 200 dpi: 28 sec

Connectivity  
Epson Connect

USB 2.0, Wi-Fi, Wi-Fi Direct  
Epson iPrint, Epson Email Print,  
Remote Print Driver  
Epson Smart Panel  
2 years or 50,000 pages  
003

Other Mobile Solution  
Warranty  
Ink Model

## L5296



Printer Type  
Technology  
Ink  
Print Resolution

Print, Scan, Copy, Fax with ADF  
On Demand Inkjet (Piezoelectric)  
4 Colours Epson Genuine Ink Bottle  
5,760 x 1,440 dpi  
(with Variable-Sized Droplet Technology)

Print Speed  
Copy Resolution  
Copy Speed  
Scan Resolution  
Scan Speed

Approx. 33 ppm / 15 ppm  
600 x 600 dpi  
Up to 7.7 ipm / 3.8 ipm  
1,200 x 2,400 dpi  
Monochrome - Flatbed : 12 sec / ADF : 4.5 ipm  
Colour - Flatbed : 29 sec / ADF : 4.5 ipm

Connectivity

USB 2.0, Ethernet, Wi-Fi IEEE 802.11b/g/n,  
Wi-Fi Direct

Epson Connect

Epson iPrint, Epson Email Print, Remote Print  
Driver

Other Mobile Solution  
Warranty  
Ink Model

Apple AirPrint, Mopria Print Service,  
Epson Smart Panel  
2 years or 30,000 pages  
003

# INK CONSUMABLES

## Epson DURABrite™ Ultra Ink



### Single-Function Inkjet Printer

	143 [Extra High Cap]	T664 [Super High Cap]	T673 [Super High Cap]	T7741 [Super High Cap]
Epson Stylus® T11/T13/T20e				
Epson Stylus® Office T30				
Epson Stylus® Office T40W				
Epson Stylus® Office T1100	■			
Epson Stylus® C79				
Epson Stylus® C90				
Epson Stylus® C110				
Epson L100/L110/L120		■		
Epson L300/L310		■		
Epson L1300		■		
Epson M100				■

### Multi-Function Inkjet Printer

	143 [Extra High Cap]	T664 [Super High Cap]	T673 [Super High Cap]	T7741 [Super High Cap]
Epson Stylus® TX100/TX101				
Epson Stylus® TX110/TX111				
Epson Stylus® TX121				
Epson Stylus® TX200/TX210				
Epson Stylus® TX220/TX400				
Epson Stylus® TX550W				
Epson Stylus® Office TX300F				
Epson Stylus® Office TX510FN				
Epson Stylus® Office TX600FNW				
Epson Stylus® CX3900/CX5900				
Epson Stylus® CX5500				
Epson Stylus® CX6900F				
Epson Stylus® CX7300/CX8300				
Epson Stylus® CX9300F				
Epson L200/L210/L220		■		
Epson L350/L360		■		
Epson L355/L365/L455		■		
Epson L550/L555/L565		■		
Epson M200				■
Epson WF Pro WF3521	■			
Epson WF Pro WF7511/WF7011	■			
Epson L605/L1455		■		■
Epson L385		■		
Epson L655		■		■
Epson L380		■		
Epson L485		■		
Epson L805			■	
Epson L850			■	
Epson L1800			■	

## Epson Claria™ Photographic Ink



### Photo Inkjet Printer

	Picture Pack TS85290
Epson PictureMate® PM235/310	■
Epson PictureMate® PM210/215	■
Epson PictureMate® PM250/270	■



# INK CONSUMABLES



Inkjet Printer	001 Series C13T03Y100-490	003 Series C13T06V199-499	005 Series C13T030100	008 Series C13T06G199-499	057 Series C13T09D100-600
EcoTank L1110		■			
EcoTank L1210		■			
EcoTank L1211		■			
EcoTank L1216		■			
EcoTank L1250		■			
EcoTank L1251		■			
EcoTank L1256		■			
EcoTank L3110		■			
EcoTank L3150		■			
EcoTank L3116		■			
EcoTank L3156		■			
EcoTank L3210		■			
EcoTank L3211		■			
EcoTank L3216		■			
EcoTank L3250		■			
EcoTank L3251		■			
EcoTank L3256		■			
EcoTank L3550		■			
EcoTank L3556		■			
EcoTank L4150	■				
EcoTank L4160	■				
EcoTank L4260	■				
EcoTank L4261	■				
EcoTank L5190		■			
EcoTank L5290		■			
EcoTank L5296		■			
EcoTank L5590		■			
EcoTank L6170	■				
EcoTank L6160	■				
EcoTank L6190	■				
EcoTank L6260	■				
EcoTank L6270	■				
EcoTank L6290	■				
EcoTank L6460				■	
EcoTank L6490				■	
EcoTank L14150	■				
EcoTank L15150				■	
Mono EcoTank M1100			■		
Mono EcoTank M1120			■		
Mono EcoTank M1140			■		
Mono EcoTank M1170			■		
Mono EcoTank M2140			■		
Mono EcoTank M2170			■		
Mono EcoTank M3170			■		
Mono EcoTank M15140				■	
EcoTank L8050					■
EcoTank L18050					■

DURABrite Ultra Inks	Ink Code
Epson WorkForce WF-7111 / WF-7611	T188 Series
	C13T289190 Blk Ink (Pigment)
Epson WorkForce WF-100	C13T290090 Clr Ink (Pigment)

# BUSINESS INKJET PRINTER



**ASEAN MARKET  
SHARE FOR  
INKJET PRINTERS**

**5 YEARS RUNNING, 2018-2022**

Source: IDC 19Q4 Quarterly Briefing (Printed in Japan, 2022)  
ASEAN: Indonesia, Malaysia, Philippines, Singapore, Thailand, Vietnam



# BUSINESS INKJET PRINTER

## MENGAPA MEMILIH BUSINESS INKJET PRINTER ?

Epson business inkjet printers menghadirkan kualitas yang luar biasa, kecepatan sangat cepat, handal dan kinerja yang optimal untuk memenuhi kebutuhan bisnis Anda.

### Revolutionary Compact PrecisionCore Linehead Design

Advanced built-in Nozzle Verification Technology memonitor kondisi nozzle dan kualitas cetak menyesuaikan secara otomatis tanpa interupsi, bahkan selama pencetakan.



### Heat-Free Technology

Teknologi Heat-Free tidak membutuhkan panas dalam proses pengeluaran tinta. Sebaliknya tekanan diterapkan pada Piezo Element, yang melentur ke belakang dan meneruskan tinta dari printhead ke depan.



### The Ecological Choice

Lakukan lebih banyak untuk bisnis Anda dan tetap lebih ramah lingkungan. Beralih ke Epson inkjet printer dan lihat bagaimana Anda dapat meningkatkan produktivitas yang lebih tinggi dan menurunkan emisi berbahaya dalam sehari-hari.

Printer inkjet kami menggunakan daya lebih kecil dari printer laser lainnya sehingga Anda tidak hanya peduli terhadap lingkungan, tetapi Anda menghemat biaya juga.

Jumlah karbon dioksida yang dipancarkan oleh laser printer akan membutuhkan hingga 8 pohon untuk menyerap semua karbon dioksida sedangkan printer inkjet Epson hanya butuh 1 pohon.

Part yang terbuang dari Printer inkjet lebih sedikit dibandingkan printer laser.

Epson Inkjet Printers Up to **85%** less power consumption<sup>1</sup> VS Laser Printers

Epson Inkjet Printers Up to **85%** less CO<sub>2</sub> generated<sup>2</sup> VS Laser Printers

Epson Inkjet Printers Up to **59%** less replacement parts<sup>3</sup> VS Laser Printers

# BUSINESS INKJET PRINTER

## Single Function Printer A4

### WORKFORCE PRO WF-5390



NEW  
PRODUCT



Print Tech	PrecisionCore™ Printhead
Print Type	Print (Single Function)
Print Resolution	4,800 x 1,200 dpi (with Variable-Sized Droplet Technology)
Print Speed	Up to 34 ppm / 34 ppm (Black#1 / Colour#2) - Draft Text - Memo (A4) Up to 24 ipm / 24 ipm (Black / Colour) - ISO 24734, A4, Simplex Up to 15 ipm / 15 ipm (Black / Colour) - ISO 24734, A4, Duplex
Paper Size	A4, 8.5x13", Legal, Letter, Executive, B5, A5, A6, B6, 5x7", 16:9 wide, 4x6", Envelopes: #10, DL, C6, C4
Power Consumption	Operating: 22 Watt Standby: 7 Watt Sleep: 1.2 Watt
Connectivity	USB 2.0, Ethernet, Wi-Fi (IEEE 802.11b/g/n), Wi-Fi Direct, NFC
Epson Connect	Epson iPrint, Epson Email Print, Remote Print Driver
Other Mobile Solutions	Apple AirPrint, Google Cloud Print, Mopria Print Service
Consumable	Up to 10,000 pages* for black ink pack & 3,000 pages* for color ink pack

## Multi Function Printer A4

### WORKFORCE PRO WF-C5890

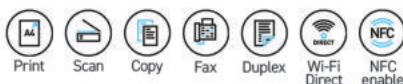

NEW  
PRODUCT



Print Tech	PrecisionCore™ Printhead
Print Type	Print, Scan, Copy, Fax with ADF
Print Resolution	4,800 x 1,200 dpi (with Variable-Sized Droplet Technology)
Print Speed	Up to 34 ppm / 34 ppm (Black#1 / Colour#2) - Draft Text - Memo (A4) Up to 24 ipm / 24 ipm (Black / Colour) - ISO 24734, A4, Simplex Up to 15 ipm / 15 ipm (Black / Colour) - ISO 24734, A4, Duplex
Copy Speed	Up to 22 ipm / 22 ipm (Black / Colour) - ISO 29183, A4, Simplex Up to 22 ipm / 22 ipm (Black / Colour) - ISO 24735, A4, 1:1
Scan Speed	Monochrome 200 dpi: Flatbed / ADF (simplex) / ADF (duplex), 5 sec / 24 ppm / 8 ipm Colour 200 dpi: Flatbed / ADF (simplex) / ADF (duplex), 5 sec / 24 ppm / 8 ipm
Scan Resolution	1,200 x 2,400 dpi
Paper Size	A4, 8.5x13", Legal, Letter, Executive, B5, A5, A6, B6, 5x7", 16:9 wide, 4x6", Envelopes: #10, DL, C6, C4
Power Consumption	Operating: 25 Watt Standby: 12 Watt Sleep: 1.5 Watt
Connectivity	USB 2.0, Ethernet, Wi-Fi (IEEE 802.11b/g/n), Wi-Fi Direct, NFC
Epson Connect	Epson iPrint, Epson Email Print, Remote Print Driver, Scan to Cloud
Other Mobile Solutions	Apple AirPrint, Google Cloud Print, Mopria Print Service
Consumable	Up to 10,000 pages* for black ink pack & 3,000 pages* for color ink pack

# BUSINESS INKJET PRINTER

## Multi Function Printer A4



### WORKFORCE PRO WF-C579R



reddot award 2019  
winner



<b>Print Tech</b>	PrecisionCore™ Printhead
<b>Print Type</b>	Print, Scan, Copy, Fax with ADF
<b>Print Resolution</b>	4,800 x 1,200 dpi
	(with Variable-Sized Droplet Technology)
<b>Print Speed</b>	Up to 34 ppm / 34 ppm (Black#1 / Colour#2) - Draft Text - Memo (A4)
	Up to 24 ipm / 24 ipm (Black / Colour) - ISO 24734, A4, Simplex
	Up to 22 ipm / 22 ipm (Black / Colour) - ISO 29183, A4, Simplex
<b>Copy Speed</b>	Up to 22 ipm / 22 ipm (Black / Colour) - ISO 29183, A4, Simplex
	Up to 22 ipm / 22 ipm (Black / Colour) - ISO 24735, A4, 1:1
<b>Scan Speed</b>	Monochrome 200 dpi: 5 sec (flatbed, A4 Landscape)
	Colour 200 dpi: 5 sec (flatbed, A4 Landscape)
	ADF (duplex), 5 sec / 24 ppm / 8 ipm
<b>Scan Resolution</b>	1,200 x 2,400 dpi
<b>Paper Size</b>	A4, 8.5x13", Legal, Letter, Executive, B5, A5, A6, B6, 5x7", 16:9 wide, 4x6", Envelopes: #10, DL, C6, C4
<b>Power Consumption</b>	Operating: 29 Watt
	Standby: 14 Watt
	Sleep: 1.3 Watt
<b>Connectivity</b>	USB 2.0, Ethernet, Wi-Fi (IEEE 802.11b/g/n), Wi-Fi Direct
<b>Epson Connect</b>	Epson iPrint, Epson Email Print, Remote Print Driver, Scan to Cloud
<b>Other Mobile Solutions</b>	Apple AirPrint, Google Cloud Print, Mopria Print Service
<b>Consumable</b>	Up to 50,000 pages* ink packs

### L6550



<b>Printer Type</b>	Print, Scan, Copy, Fax with ADF
<b>Technology</b>	PrecisionCore™ Printhead
<b>Print Resolution</b>	4,800 x 2,400 dpi
<b>Print Speed</b>	Up to 32 ppm / 22 ppm
	25/12 ipm (ISO doc)
<b>Copy Resolution</b>	600 x 600 dpi
<b>Copy Speed</b>	Up to 23 ipm / 10 ipm
<b>Scan Resolution</b>	1,200 x 2,400 dpi
<b>Scan Speed</b>	Monochrome: 200dpi Up to 5.0sec / 27.5 ppm / 11 ipm
	Colour: 200dpi Up to 10sec / 9.0 ppm / 6.0 ipm
<b>Connectivity</b>	USB 2.0, Ethernet (100BASE-TX/10BASE-T), Wi-Fi (IEEE 802.11 b/g/n), Wi-Fi Direct
<b>Epson Connect</b>	Epson iPrint, Epson Email Print, Remote Print Driver, Scan to Cloud
<b>Other Mobile Solution</b>	Apple AirPrint, Mopria Print Service
<b>Ink Model</b>	008

# BUSINESS INKJET PRINTER

## Multifunction Printer A4

### L6580



Printer Type	Print, Scan, Copy, Fax with ADF
Technology	PrecisionCore™ Printhead
Ink	4 Colours Epson Genuine Ink Bottle
Print Resolution	4,800 x 1,200 dpi
Print Speed	Up to 32 ppm / 32 ppm 25/25 ipm (ISO doc)
Copy Resolution	600 x 600 dpi
Copy Speed	Up to 23 ipm / 23 ipm
Scan Resolution	1,200 x 2,400 dpi
Scan Speed	Monochrome: 5 sec / Up to 27.5 ipm / 11.5 ipm Colour: 10 sec / Up to 9.0 ipm / 6.0 ipm
Connectivity	USB 2.0, Ethernet (100BASE-TX/10BASE-T), Wi-Fi (IEEE 802.11 b/g/n), Wi-Fi Direct
Epson Connect	Epson iPrint, Epson Email Print, Remote Print Driver, Scan to Cloud
Other Mobile Solution	Apple AirPrint, Mopria Print Service
Ink Model	008

## Multifunction Printer A3

### L15160



Printer Type	Print, Scan, Copy, Fax with ADF
Technology	PrecisionCore™ Printhead
Ink	4 Colours Epson Genuine Ink Bottle
Print Resolution	4,800 x 2,400 dpi
Print Speed	Up to 32 ppm / 32 ppm 25/21 ipm (ISO doc)
Copy Resolution	600 x 600 dpi
Copy Speed	Up to 23 ipm / 23 ipm
Scan Resolution	1,200 x 2,400 dpi
Scan Speed	Black: 5 sec / Up to 26.0 ipm / 11.5 ipm Colour: 10 sec / Up to 9.0 ipm / 6.0 ipm
Connectivity	USB 2.0, Ethernet, Wi-Fi IEEE 802.11 b/g/n, Wi-Fi Direct
Epson Connect	Epson iPrint, Epson Email Print, Remote Print Driver, Scan to Cloud
Other Mobile Solution	Apple AirPrint, Mopria Print Service
Warranty	2 years or 80,000 prints
Ink Model	008

# BUSINESS INKJET PRINTER

## Multifunction Printer A3

### L15180



Printer Type	Print, Scan, Copy, Fax with ADF
Technology	PrecisionCore™ Printhead
Ink	4 Colours Epson Genuine Ink Bottle
Print Resolution	4,800 x 1,200 dpi
Print Speed	Up to 32 ppm / 32 ppm 25/21 ipm (ISO doc)
Copy Resolution	600 x 600 dpi
Copy Speed	Up to 23 ipm / 23 ipm
Scan Resolution	1,200 x 2,400 dpi
Scan Speed	Black: 5 sec / Up to 26.0 ipm   11.5 ipm Colour: 10 sec / Up to 9.0 ipm   6.0 ipm
Connectivity	USB 2.0, Ethernet, Wi-Fi IEEE 802.11 b/g/n, Wi-Fi Direct
Epson Connect	Epson iPrint, Epson Email Print, Remote Print Driver, Scan to Cloud
Other Mobile Solution	Apple AirPrint, Mopria Print Service
Warranty	2 years or 80,000 prints
Ink Model	008

## Monochrome Multifunction Printer A3

### M15180

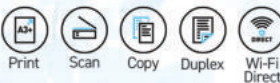

Printer Type	Print, Scan and Copy with ADF
Technology	PrecisionCore™ Printhead
Ink	Black
Print Resolution	4,800 x 2,400 dpi
Print Speed	Up to 32 ppm / 32 ppm 25/16 ipm (ISO doc)
Copy Resolution	600 x 600 dpi
Copy Speed	Up to 23 ipm / 23 ipm
Scan Resolution	1,200 x 2,400 dpi
Scan Speed	Black: 5 sec / Up to 26.0 ipm   11.5 ipm Colour: 10 sec / Up to 9.0 ipm   6.0 ipm
Connectivity	USB 2.0, Ethernet, Wi-Fi IEEE 802.11 b/g/n, Wi-Fi Direct
Epson Connect	Epson iPrint, Epson Email Print, Remote Print Driver, Scan to Cloud
Other Mobile Solution	Apple AirPrint, Mopria Print Service
Warranty	2 years or 80,000 prints
Ink Model	008

# BUSINESS INKJET PRINTER

## Multifunction Printer A3

### WORKFORCE PRO WF-C878R



Print Method	PrecisionCore™ Print Head
Max Resolution	4,800 x 1,200 dpi (with Variable-Sized Droplet Technology)
Min Droplet Size	4.6 pl
Print Speed	Max Draft Text - Memo (A4) : Approx. 35 ppm / 35 ppm (Black / Colour) ISO 24734, A4, Simplex : Approx. 25 ipm / 24 ipm (Black / Colour) ISO 24734, A4, Duplex : Approx. 17 ipm / 16 ipm (Black / Colour) ISO 24734.2, A3, Simplex : Approx. 13 ipm / 13 ipm (Black / Colour) ISO 24734.2, A3, Duplex : Approx. 11 ipm / 11 ipm (Black / Colour)
Copy Resolution	600 x 600 dpi
Copy Speed	ISO 29183, A4, Simplex (Flatbed) Approx. 23 ipm / 22 ipm (Black / Colour) ISO 24735, A4, Simplex (ADF) Approx. 21 ipm / 21 ipm (Black / Colour) ISO 24735, A4, Duplex (ADF) Approx. 15 ipm / 15 ipm (Black / Colour)
Scan Resolution	600 x 600 dpi
Scan Speed	1,200 x 2,400 dpi (A4 Landscape, Flatbed / ADF Simplex / ADF Duplex) Monochrome 200 dpi: 4.0 sec / 25 ppm / 45 ipm Colour 200 dpi: 5.0 sec / 25 ppm / 45 ipm
Memory	3,072 MB

### WORKFORCE PRO WF-C879R



Print Method	PrecisionCore™ Print Head
Max Resolution	4,800 x 1,200 dpi (with Variable-Sized Droplet Technology)
Min Droplet Size	4.6 pl
Print Speed	Max Draft Text - Memo (A4) : Approx. 35 ppm / 35 ppm (Black / Colour) ISO 24734, A4, Simplex : Approx. 26 ipm / 25 ipm (Black / Colour) ISO 24734, A4, Duplex : Approx. 18 ipm / 17 ipm (Black / Colour) ISO 24734.2, A3, Simplex : Approx. 13 ipm / 13 ipm (Black / Colour) ISO 24734.2, A3, Duplex : Approx. 11 ipm / 11 ipm (Black / Colour)
Copy Resolution	600 x 600 dpi
Copy Speed	ISO 29183, A4, Simplex (Flatbed) : Approx. 24 ipm / 23 ipm (Black / Colour)
Scan Resolution	600 x 600 dpi
Scan Speed	(A4 Landscape, Flatbed / ADF Simplex / ADF Duplex) Monochrome 200 dpi: 3.7 sec / 50 ppm / 100 ipm Colour 200 dpi: 3.7 sec / 50 ppm / 100 ipm
Memory	4,224 MB



# BUSINESS INKJET PRINTER

## WORKFORCE ENTERPRISE AM-C4000

NEW  
PRODUCT



<b>Print Tech</b>	PrecisionCore Line Head Inkjet Technology
<b>Print Type</b>	Print, Scan, Copy, Fax
<b>Print Resolution</b>	600 x 2,400 dpi
<b>Print Speed</b>	Approx. 40 ipm / 40 ipm (Black/ Colour) - ISO 24734, A4, Simplex / Duplex Approx. 23 ipm / 11 ipm (Black/ Colour) - ISO 24734.2, A3, Simplex / Duplex Approx. 7.6 sec / 7.6 sec (Black/ Colour) - First Page Out Time
<b>Copy Speed</b>	Approx. 40 ipm (Black and Colour) - ISO 29183, A4, Simplex (Flatbed) Approx. 40 ipm / 40 ipm (Black/ Colour) - ISO 24735, A4, Simplex (ADF 1:1) Approx. 40 ipm / 40 ipm (Black/ Colour) - ISO 24735, A4, Duplex (ADF 1:2 / 2:2)
<b>Scan Speed</b>	A4 Landscape: 3.0 sec, A3: 4.0 sec, A4: 60 ppm / 120 ipm A3: 30 ppm / -
<b>Scan Resolution</b>	600 x 600 dpi
<b>Paper Size</b>	A3+, A3, A4, B5, A5, A6, 5x7", 4x6", Legal, 8.5x13", Letter, Envelopes: #10, DL, C6, C5, C4
<b>Power Consumption</b>	Operating: 110 Watt, Standby: 46 Watt, Sleep: 1.0 Watt
<b>Connectivity</b>	USB 3.0, Ethernet, Ethernet, Direct Wi-Fi, Fax, Storage with HDD
<b>Epson Connect</b>	Epson iPrint, Epson Email Print, Remote Print Driver, Scan to Cloud
<b>Other Mobile Solutions</b>	Apple AirPrint, Mopria Print Service, Microsoft Universal Print
<b>Consumable</b>	Up to 50,000 pages *for blank ink pack

## WORKFORCE ENTERPRISE AM-C5000

NEW  
PRODUCT



<b>Print Tech</b>	PrecisionCore Line Head Inkjet Technology
<b>Print Type</b>	Print, Scan, Copy, Fax
<b>Print Resolution</b>	600 x 2,400 dpi
<b>Print Speed</b>	Approx. 50 ipm / 50 ipm (Black/ Colour) - ISO 24734, A4, Simplex / Duplex Approx. 30 ipm / 15 ipm (Black/ Colour) - ISO 24734.2, A3, Simplex / Duplex Approx. 6.7 sec / 6.7 sec (Black/ Colour) - First Page Out Time
<b>Copy Speed</b>	Approx. 50 ipm (Black and Colour) - ISO 29183, A4, Simplex (Flatbed) Approx. 50 ipm / 50 ipm (Black/ Colour) - ISO 24735, A4, Simplex (ADF 1:1) Approx. 50 ipm / 50 ipm (Black/ Colour) - ISO 24735, A4, Duplex (ADF 1:2 / 2:2)
<b>Scan Speed</b>	A4 Landscape: 3.0 sec, A3: 4.0 sec, A4: 60 ppm / 120 ipm A3: 30 ppm / -
<b>Scan Resolution</b>	600 x 600 dpi
<b>Paper Size</b>	A3+, A3, A4, B5, A5, A6, 5x7", 4x6", Legal, 8.5x13", Letter, Envelopes: #10, DL, C6, C5, C4
<b>Power Consumption</b>	Operating: 110 Watt, Standby: 46 Watt, Sleep: 1.0 Watt
<b>Connectivity</b>	USB 3.0, Ethernet, Ethernet, Direct Wi-Fi, Fax, Storage with HDD
<b>Epson Connect</b>	Epson iPrint, Epson Email Print, Remote Print Driver, Scan to Cloud
<b>Other Mobile Solutions</b>	Apple AirPrint, Mopria Print Service, Microsoft Universal Print
<b>Consumable</b>	Up to 50,000 pages *for blank ink pack

# BUSINESS INKJET PRINTER

## Multifunction Printer A3

### WORKFORCE ENTERPRISE AM-C6000

**NEW  
PRODUCT**



Print Tech	PrecisionCore Line Head Inkjet Technology
Print Type	Print, Scan, Copy, Fax
Print Resolution	600 x 2,400 dpi
Print Speed	Approx. 60 ipm / 60 ipm (Black/ Colour) - ISO 24734, A4, Simplex / Duplex Approx. 36 ipm / 20 ipm (Black/ Colour) - ISO 24734.2, A3, Simplex / Duplex Approx. 6.1 sec / 6.1 sec (Black/ Colour) - First Page Out Time
Copy Speed	Approx. 60 ipm (Black and Colour) - ISO 29183, A4, Simplex (Flatbed) Approx. 60 ipm / 60 ipm (Black/ Colour) - ISO 24735, A4, Simplex (ADF 1:1) Approx. 60 ipm / 60 ipm (Black/ Colour) - ISO 24735, A4, Duplex (ADF 1:2 / 2:2)
Scan Speed	A4 Landscape: 3.0 sec, A3: 4.0 sec, A4: 60 ppm / 120 ipm A3: 30 ppm / -
Scan Resolution	600 x 600 dpi
Paper Size	A3+, A3, A4, B5, A5, A6, 5x7", 4x6", Legal, 8.5x13", Letter, Envelopes: #10, DL, C6, C5, C4
Power Consumption	Operating: 110 Watt, Standby: 46 Watt, Sleep: 1.0 Watt
Connectivity	USB 3.0, Ethernet, Ethernet, Direct Wi-Fi, Fax, Storage with HDD
Epson Connect	Epson iPrint, Epson Email Print, Remote Print Driver, Scan to Cloud
Other Mobile Solutions	Apple AirPrint, Mopria Print Service, Microsoft Universal Print
Consumable	Up to 50,000 pages* for blank ink pack

### WORKFORCE PRO WF-C20750



Print Tech	PrecisionCore™ Linehead Inkjet Technology
Print Type	Print, Scan, Copy, Fax
Print Resolution	600 x 2,400 dpi
Print Speed	Approx. 75 ipm / 75 ipm (Black / Colour) - ISO 24734, A4, Simplex / Duplex Approx. 45 ipm / 25.4 ipm (Black / Colour) - ISO 24734.2, A3, Simplex / Duplex Approx. 5.5 sec / 5.5 sec (Black / Colour) - ISO First Page Out Time
Copy Speed	Approx. 75 ipm (Black / Colour) - ISO 29183, A4, Simplex (Flatbed) Approx. 75 ipm (Black / Colour) - ISO 24735, A4, Simplex (ADF 1:1) Approx. 75 ipm (Black / Colour) - ISO 24735, A4, Duplex (ADF 1:2 / 2:2)
Scan Speed	3.7 sec / 60 ppm / 110 ppm (200 dpi; Mono / Colour)
Scan Resolution	600 x 1,200 dpi
Paper Size	A3+, A3, A4, B5, A5, A6, 5x7", 4x6", Legal, 8.5x13", Letter, Envelopes: #10, DL, C6, C5, C4
Power Consumption	Operating: 160 Watt Standby: 77 Watt Sleep: 1.4 Watt
Connectivity	USB 3.0, Ethernet (1000BASE-T/100BASE-TX/10BASE-T), Wi-Fi (IEEE 802.11b/g/n), Wi-Fi Direct, NFC
Epson Connect	Epson iPrint, Epson Email Print, Remote Print Driver, Scan to Cloud
Other Mobile Solutions	Google Cloud Print, Mopria Print Service
Consumable	Up to 100,000 pages* for black ink pack

# BUSINESS INKJET PRINTER

## WORKFORCE PRO WF-C21000



Print Tech	PrecisionCore™ Linehead Inkjet Technology
Print Type	Print, Scan, Copy, Fax
Print Resolution	600 x 2,400 dpi
Print Speed	Approx. 100 ipm / 100 ipm (Black / Colour) – ISO 24734, A4, Simplex / Duplex Approx. 54 ipm / 36.3 ipm (Black / Colour) – ISO 24734.2, A3, Simplex / Duplex Approx. 5.0 sec / 5.0 sec (Black / Colour) – First Page Out Time
Copy Speed	Approx. 100 ipm (Black / Colour) – ISO 29183, A4, Simplex (Flatbed) Approx. 100 ipm (Black / Colour) – ISO 24735, A4, Simplex (ADF 1:1) Approx. 100 ipm (Black / Colour) – ISO 24735, A4, Duplex (ADF 1:2 / 2:2)
Scan Speed	3.7 sec / 60 ppm / 110 ppm (200 dpi; Mono / Colour)
Scan Resolution	600 x 1,200 dpi
Paper Size	A3+, A3, A4, B5, A5, A6, 5x7", 4x6", Legal, 8.5x13", Letter, Envelopes: #10, DL, C6, C5, C4
Power Consumption	Operating: 170 Watt Standby: 77 Watt Sleep: 1.4 Watt
Connectivity	USB 3.0, Ethernet (1000BASE-T/100BASE-TX/10BASE-T), Wi-Fi (IEEE 802.11b/g/n), Wi-Fi Direct, NFC
Epson Connect	Epson iPrint, Epson Email Print, Remote Print Driver, Scan to Cloud
Other Mobile Solutions	Apple AirPrint, Google Cloud Print, Mopria Print Service
Consumable	Up to 100,000 pages* for black ink pack

## Monochrome Multifunction Printer A3

## WORKFORCE PRO WF-M21000



Print Tech	PrecisionCore™ Linehead Inkjet Technology
Print Type	Print, Scan, Copy, Fax
Print Resolution	600 x 2,400 dpi
Print Speed	Approx. 100 ipm / 100 ipm (Black) – ISO 24734, A4, Simplex / Duplex Approx. 54 ipm / 36.3 ipm (Black) – ISO 24734.2, A3, Simplex / Duplex Approx. 5.0 sec / 5.0 sec (Black) – First Page Out Time
Copy Speed	Approx. 100 ipm / 100 ipm (black) – ISO 29183, A4, Simplex (Flatbed) Approx. 100 ipm / 100 ipm (black) – ISO 24735, A4, Simplex (ADF, 1:1)
Scan Speed	3.7 sec / 60 ppm / 110 ppm (200 dpi; Mono / Colour)
Scan Resolution	600 x 600 dpi
Paper Size	A3+, A3, A4, B5, A5, A6, 5x7", 4x6", Legal, 8.5x13", Letter, Envelopes: #10, DL, C6, C5, C4
Power Consumption	Operating: 180 Watt Standby: 77 Watt Sleep: 1.4 Watt
Connectivity	USB 3.0, Ethernet (1000BASE-T/100BASE-TX/10BASE-T), Wi-Fi (IEEE 802.11b/g/n), Wi-Fi Direct, NFC
Epson Connect	Epson iPrint, Epson Email Print, Remote Print Driver, Scan to Cloud
Other Mobile Solutions	Google Cloud Print, Mopria Print Service
Consumable	Up to 100,000 pages* for black ink pack

# BUSINESS INKJET PRINTER

## T-Series Surecolor Technical Series

### SURECOLOR SC-T3130

Versatile  
Media Handling

Printhead

Up to  
1.5mm ThickUp to 24"  
Wide\*

Max Print Width	24 inch wide (610 mm)
Print Head	PrecisionCore TFP with VSDT and Auto Head Alignment
Max Resolution	2400 dpi x 1200 dpi
Min Droplet Size	4.0 pl
Ink System	Epson Ultrachrome XD2 Pigment Ink
Type	All-Pigment Aqueous
Colours	C+M+Y+K
Cartridge Size	CMY 26/50 ml, K 50/80 ml
Print Speed (A1 sheet)	CAD A1: 34 sec
Paper Size	Single roll top loaded spindle, 2" core, 0.05-0.21 mm thick, 329-610 mm wide, 110 mm max diameter, 3kg max weight
Interface	USB 3.0 & Ethernet 10Base-T/100Base-TX/1000Base-T, Wi-Fi, Wi-Fi Direct, Air Print
OS Compatibility	Windows 10 / 8.1 / 8 / 7 / Vista / XP, Mac OSx10.6.8 or later
Memory	1 GB
Power Consumption	28W Operating, 8W Standby, 1.6W Sleep
Dimensions (W x D x H)	970 x 505 x 230
Weight	38 kg

### SURECOLOR SC-T3130N

Versatile  
Media Handling

Printhead

Up to  
1.5mm ThickUp to 24"  
Wide\*

Max Print Width	24 inch wide (610 mm)
Print Head	Precision Core TFP with VSDT and Auto Head Alignment
Max Resolution	2400 dpi x 1200 dpi
Min Droplet Size	4.0pl
Ink System	Epson Ultrachrome XD2 Pigment Ink
Type	All-Pigment Aqueous
Colours	C+M+Y+K
Cartridge Size	CMY 26/50 ml, K50/80 ml
Print Speed (A1 sheet)	CAD A1:34 sec
Paper Size	Single roll top loaded spindle, 2" core, 0.05-0.21 mm thick, 329-610mm wide, 110 mm max diameter, 3 kg max weight
Interface	USB 3.0 & Ethernet 10Base-T/100Base-TX/1000Base-T, Wi-Fi, Wi-Fi Direct, Air Print
OS Compatibility	Windows 10 / 8.1 / 8 / 7 / Vista / XP, Mac OSx10.6.8 or later
Memory	1 GB
Power Consumption	28W Operating, 8W Standby, 1.6 W Sleep
Dimensions (W x D x H)	970 x 505 x 230 cm
Weight	27 kg

# BUSINESS INKJET PRINTER

## SURECOLOR SC-T3130X



Max Print Width Print Head	24 inch wide (610 mm) Precision Core TFP with VSDT and Auto Head Alignment
Max Resolution	2400 dpi x 1200 dpi
Min Droplet Size	3.8pl
Ink System	Epson Ultrachrome XD2 Pigment Ink
Type	All-Pigment Aqueous
Colours	C+M+Y+K
Cartridge Size	140 ml
Print Speed (A1 sheet)	CAD A1:34 sec
Paper Size	Single roll top loaded spindle, 2" core, 0.05-0.21 mm thick, 329-610mm wide, 110 mm max diameter, 3 kg max weight
Interface	USB 3.0 & Ethernet 10Base-T/100Base-TX/1000Base-T, Wi-Fi, Wi-Fi Direct, Air Print
OS Compatibility	Windows 10/ 8.1 / 8 / 7 / Vista / XP, Mac OSx10.6.8 or later
Memory	1 GB
Power Consumption	28W Operating, 8W Standby, 1.6 W Sleep
Dimensions (W x D x H)	970 x 577 x 245 cm
Weight	29 kg

## SURECOLOR SC-T3130M

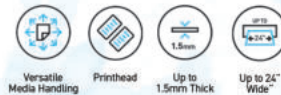

Max Print Width Print Head	24 inch wide (610 mm) Precision Core TFP with VSDT and Auto Head Alignment
Max Resolution	2400 dpi x 1200 dpi
Min Droplet Size	4.0pl
Ink System	Epson Ultrachrome XD2 Pigment Ink
Type	All-Pigment Aqueous
Colours	C+M+Y+K
Cartridge Size	CMY 26/50 ml, K 50/80 ml
Scan Technology	Contact Image Sensor (CIS) with RGB filters
Light Source	Dual Low Angle / RGB LED
Feed System	Sheet pass-through
Max Resolution	600 dpi
Max Scan Speed	11.43 cm/s or 4.5 ips (Colour) 19.05 cm/s or 7.5 ips (Mono)
Max Copy Speed	38 sec per A1 sheet mono 44 sec per A1 sheet colour
Print Speed (A1 sheet)	CAD A1:34 sec
Paper Size	Single roll top loaded spindle, 2" core, 0.05-0.21 mm thick, 329-610mm wide, 110 mm max diameter, 3 kg max weight
Interface	USB 3.0 & Ethernet 10Base-T/100Base-TX/1000Base-T, Wi-Fi, Wi-Fi Direct, Air Print
OS Compatibility	Windows 10/ 8.1 / 8 / 7 / Vista / XP, Mac OSx10.6.8 or later
Memory	1 GB+8GB*For scanner data processing
Power Consumption	24W Operating, 11W Standby, 2.0 W Sleep
Dimensions (W x D x H)	970 x 292 x 230
Weight	44.4 kg

# BUSINESS INKJET PRINTER

## T-Series Surecolor Technical Series

### SURECOLOR SC-T3270



Max Print Width	24 inch wide (borderless)
Print Head	PrecisionCore TFP with VSDT and Auto Head Alignment
Max Resolution	2880 dpi x 1440 dpi
Min Droplet Size	3.5pl
Ink System	Epson Ultrachrome® XD
Type	All-Pigment Aqueous
Colours	C+Y+M+Mk / Pk (Black Matte / Photo Black)
Cartridge Size	110 / 350 / 700 ml
Print Speed	Production POS: 28 sec (360 x 720 dpi) Quality POS: 66 sec (720 x 720 dpi) Production CAD: 30 sec (360 x 720 dpi) Quality CAD: 60 sec (720x1440 dpi)
Paper Size	Spindle-less front loading single roll, 2" or 3" core, 0.08-0.5 mm thick, 254-610 mm wide, 150 mm max diameter with Media Barcode System & auto tension control
Interface	USB 2.0 & Ethernet
OS Compatibility	10Base-T / 100Base-TX / 1000Base-T Windows XP / Vista / 7 / 8 (32 / 64bit), Mac OSx10.5 or later, Win server 2003 & 2008 Standard / Standard 64bit
Memory	1 GB, Optional 320 GB HDD
Power Requirement	52W Operating, 16W Ready, 3W Sleep
Dimensions (W x D x H)	1120 x 248 x 760 mm
Weight	approx. 54 kg

### SURECOLOR SC-T3430

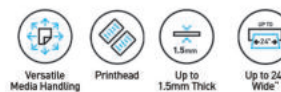

Max Print Width	24 inch wide (610 mm)
Print Head	PrecisionCore TFP with VSDT and Auto Head Alignment
Max Resolution	2,400 dpi x 1,200 dpi
Min Droplet Size	4.0pl
Ink System	Epson Ultrachrome® XD2
Type	All-Pigment Aqueous
Colours	C+M+Y+K
Cartridge Size	CMYK 110/350 ml
Print Speed (A1 Sheet)	CAD A1: 25 sec
Paper Size	Single roll top loaded spindle, 2" core, 3" core for plain paper, 0.08 to 0.3 mm thick, 254-610 mm wide, 170 mm max diameter, max weight 12kg
Interface	USB 3.0 & Ethernet 10Base-T / 100Base-TX / 1000Base-T, Wi-Fi, Wi-Fi Direct, Air Print
OS Compatibility	Windows 10 / 8.1 / 8 / 7 / Vista / XP, Mac OS x 10.6.8 or later
Memory	1 GB
Power Consumption	34W Operating, 13W Standby, 1.3W Sleep
Dimensions (W x D x H)	1,080 x 668 x 585 mm
Weight	64kg

# BUSINESS INKJET PRINTER

## SURECOLOR SC-T3435



- Max Print Width 24 inch wide (610 mm)
- Print Head Precision Core TFP with VSDT and Auto Head Alignment
- Max Resolution 2400 dpi x 1200 dpi
- Min Droplet Size 4.0pl
- Ink System Epson Ultrachrome XD2 Pigment Ink
- Type All-Pigment Aqueous
- Colours C+M+Y+K
- Cartridge Size CMYK, 100 ml/350 ml/700 ml
- Scan Integration Available connect with Business Inkjet Printer Scanner : WF-C17590, WF-C20590, WF-C20600, WF-C20750, WF-C21000, WF-M20590, WF-R8591, WF-C869R, WF-C878R, WF-C879R,
- Print Speed (A1 sheet) CAD A1:25 sec
- Paper Size Single roll top loaded spindle, 2/3" core, 0.08-0.3 mm thick, 254-610mm wide, 170 mm max diameter, 8 kg max weight
- Interface USB 3.0 & Ethernet 10Base-T/100Base-TX/1000Base-T, Wi-Fi, Wi-Fi Direct, Air Print
- OS Compatibility Windows 10/ 8.1 / 8 / 7 / Vista / XP, Mac OSx10.6.8 or later
- Memory 1 GB
- Power Consumption 34W Operating, 13W Standby, 1.3 Sleep
- Dimensions (W x D x H) 1080 x 1060 x 750 cm (with stand)
- Weight 64 kg

## SURECOLOR SC-T5130

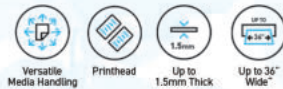

- Max Print Width 36 inch wide (914 mm)
- Print Head PrecisionCore TFP with VSDT and Auto Head Alignment
- Max Resolution 2,400 dpi x 1,200 dpi
- Min Droplet Size 4.0pl
- Ink System Epson Ultrachrome® XD2
- Type All-Pigment Aqueous
- Colours C+M+Y+K
- Cartridge Size CMY 26/50 ml, K 50/80 ml
- Print Speed (A3 Sheet) CAD A3: 31 sec
- Paper Size Single roll top loaded spindle, 2" core, 0.05-0.21 mm thick, 329-910 mm wide, 110 mm max diameter, 5kg max weight
- Interface USB 3.0 & Ethernet 10Base-T / 100Base-TX / 1000Base-T, Wi-Fi, Wi-Fi Direct, Air Print
- OS Compatibility Windows 10 / 8.1 / 8 / 7 / Vista / XP, Mac OS x 10.6.8 or later
- Memory 1 GB
- Power Consumption 28W Operating, 8W Standby, 1.6W Sleep
- Dimensions (W x D x H) 1,268 x 913 x 696 mm
- Weight 46 kg

# BUSINESS INKJET PRINTER

**T** Surecolor Technical Series

## SURECOLOR SC-T7730D



Versatile Media Handling



Printhead



Up to 1.5mm Thick



Up to 36" Wide



Max Print Width	44 inch wide (borderless)
Print Head	2.64 MicroTFP
Max Resolution	2400 dpi x 1200 dpi
Min Droplet Size	3.5 pl
Ink System	Ultrachrome XD3 pigment ink
Type	All Pigment Aqueous
Colours	C+M+Y+R+MK+PK
Cartridge Size	110/350/700 ml
Paper Size	Two automatic roll switch (top-and front loading), Rolls (Roll: 0.07mm – 0.8mm, Cut Sheet: 0.07mm – 0.8mm, Poster Board: 0.8mm – 1.5mm)
Print Speed (A1)	16 Sec
Media Thickness	Up to 1.5mm
Interface	USB 3.0, Ethernet (100BASE-TX/1000BASE-T), Wi-Fi (IEEE802.11b/g/n), Wi-Fi Direct (Simple AP, up to 8 device connections), USB Host Direct Print (PDF, TIFF, JPEG, HP-GL/2, HP RTL)
Memory	4GB, Optional 960GB SSD
Power Consumption	70 W
Dimensions (W x D x H)	1848x499x975 mm
Weight	155 kg

# EPSON

**BE**  
**cool**



**PRODUCE BIG,  
ACCURATE PRINTS  
WITH A SMALLER IMPACT.**



# BUSINESS INKJET PRINTER

## SURECOLOR SC-T5130M



- Max Print Width** 36 inch wide (914 mm)
- Print Head** Precision Core TFP with VSDT and Auto Head Alignment
- Max Resolution** 2400 dpi x 1200 dpi
- Min Droplet Size** 4.0pl
- Ink System** Epson Ultrachrome XD2 Pigment Ink
- Type** All-Pigment Aqueous
- Colours** C+M+Y+K
- Cartridge Size** CMY 26/50 ml, K 50/80 ml
- Scan Technology** Contact Image Sensor (CIS) with RGB filters
- Light Source** Dual Low Angle / RGB LED
- Feed System** Sheet pass-through
- Max Resolution** 600 dpi
- Max Copy Speed** 11.43 cm/s or 4.5 ips (Colour)  
19.05 cm/s or 7.5 ips (Mono)
- Print Speed (A1 sheet)** 38 sec per A1 sheet mono  
44 sec per A1 sheet colour
- Paper Size** CAD A1:31 sec
- Interface** Single roll top loaded spindle, 2" core, 0.05-0.21 mm thick, 297-914mm wide, 110 mm max diameter, 3 kg max weight
- OS Compatibility** USB 3.0 & Ethernet  
10Base-T/100Base-TX/1000Base-T, Wi-Fi, Wi-Fi Direct, Air Print
- Memory** Windows 10/ 8.1 / 8 / 7 / Vista / XP, Mac OSx10.6.8 or later
- Power Consumption** 1 GB+8GB\*For scanner data processing
- Dimensions (W x D x H)** 26W Operating, 12W Standby, 2.0 Sleep
- Weight** 1268 x 975 x 696 cm (with stand)  
54.8 kg

## SURECOLOR SC-T5270/T5270D

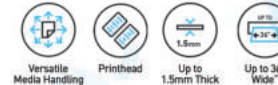

SC-T5270 Single Roll  
SC-T5270D Dual Roll



- Max Print Width** 36 inch wide (914 mm)
- Print Head** PrecisionCore TFP with VSDT and Auto Head Alignment
- Max Resolution** 2,880 dpi x 1,440 dpi
- Min Droplet Size** 3.5pl
- Ink System** Epson Ultrachrome® XD
- Type** All-Pigment Aqueous
- Colours** C+Y+M+Mk/Pk (Black Matte/Photo Black)
- Cartridge Size** 110/350/700 ml
- Paper Size** Spindle-less front-loading single roll, 2" or 3" core, 0.08-0.5 mm thick, 254-914 mm wide, 150 mm max diameter with Media Barcode System & auto tension control
- Print Speed** Production Post: 28 sec (360 dpi x 720 dpi a1 sheet)  
50 sec (360 x 720 dpi, A0 sheet)  
Quality Post: 66 sec (720 x 720 dpi, A1 sheet)  
Production CAD: 30 sec (360 x 720 dpi, A1 sheet)  
54 sec (360 x 720 dpi, A0 sheet)  
Quality CAD: 60 sec (720x1440 dpi, A1 sheet)
- Media Thickness** **SC-T5270**  
Single top-loading rollfeed, Manual top-loading sheet fed, Manual front-loading thick board feed Rolls (0.08mm-0.5mm thickness; max roll diameter 150mm) = 254 - 914mm width  
Sheets (0.08mm - 0.8mm thickness) = 210 - 914mm  
Thickness board = 0.8 - 1.5mm  
**SC-T5270D**  
Two automatic roll feeds (top-and front loading), Manual top-loading sheet fed, Manual front-loading thick board feed Rolls (0.08mm-0.5mm thickness; max roll diameter 150mm) = 254 - 914 mm width, Sheets (0.08mm - 0.8mm thickness) = 210 - 914 mm, Thickness board = 0.8 - 1.5mm
- Scan Performance (MFP Configurations Only)** Max Scan Speed 3.3 inch/sec greyscale / 8.4 inch/sec colour.  
Scan/Copy up to 600 dpi
- Interface** USB 2.0 & Ethernet 10Base-T / 100Base-TX / 1000Base-T
- OS Compatibility** Windows XP / Vista / 7 / 8 (32/64bit), Mac OS x 10.5 or later, Win server 2003 & 2008 Standard/ Standard 64bit
- Memory** 1 GB, Optional 320 GB HDD
- Power Requirement** 61W Operating, 17W Ready, 3W Sleep
- Dimensions (W x D x H)** 1405 x 1128 x 1070 mm (SC-T5270),  
1539 x 1321 x 1074 mm (SC-T5270D)
- Weight** 84 kg (SC-T5270), 118 kg (SC-T5270D)

# BUSINESS INKJET PRINTER

## T-Series Surecolor Technical Series

### SURECOLOR SC-T5430

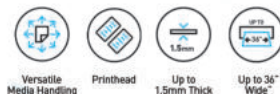

Max Print Width	36 inch wide (914 mm)
Print Head	PrecisionCore TFP with VSDT and Auto Head Alignment
Max Resolution	2400 dpi x 1200 dpi
Min Droplet Size	4.0 pl
Ink System	Epson Ultrachrome® XD2
Type	All-Pigment Aqueous
Colours	C+M+Y+K
Cartridge Size	CMYK 110/350ml
Print Speed (A1 Sheet)	CAD A1: 22 sec
Paper Size	Single roll top loaded spindle, 2" core, 3" core for plain paper, 0.08 to 0.3 mm thick, 254-914 mm wide, 170 mm max diameter, max weight 12kg
Interface	USB 3.0 & Ethernet 10Base-T / 100Base-TX / 1000Base-T, Wi-Fi, Wi-Fi Direct, Air Print
OS Compatibility	Windows 10 / 8.1 / 8 / 7 / Vista / XP, Mac OS x 10.6.8 or later
Memory	1 GB
Power Consumption	38W Operating, 13W Standby, 1.3W Sleep
Dimensions (W x D x H)	1,385 x 750 x 1,060 mm
Weight	76 kg

### SURECOLOR SC-T5435



Max Print Width	36 inch wide (914 mm)
Print Head	Precision Core TFP with VSDT and Auto Head Alignment
Max Resolution	2400 dpi x 1200 dpi
Min Droplet Size	4.0pl
Ink System	Epson Ultrachrome XD2 Pigment Ink
Type	All-Pigment Aqueous
Colours	C+M+Y+K
Cartridge Size	CMYK, 100 ml/350 ml/700 ml
Scan Integration	Available connect with Business Inkjet Printer Scanner :
	WF-C17590, WF-C20590, WF-C20600, WF-C20750, WF-C21000, WF-M20590
	WF-R8591, WF-C869R, WF-C878R, WF-C879R,
Print Speed (A1 sheet)	CAD A1:22 sec
Paper Size	Single roll top loaded spindle, 2/3" core, 0.08-0.3 mm thick, 254-914mm wide, 170 mm max diameter, 12 kg max weight
Interface	USB 3.0 & Ethernet 10Base-T/100Base-TX/1000Base-T, Wi-Fi, Wi-Fi Direct, Air Print
OS Compatibility	Windows 10/ 8.1 / 8 / 7 / Vista / XP, Mac OSx10.6.8 or later
Memory	1 GB
Power Consumption	38W Operating, 13W Standby, 1.3 Sleep
Dimensions (W x D x H)	1385 x 1070 x 750 cm (with stand)
Weight	76 kg

# BUSINESS INKJET PRINTER

## SURECOLOR SC-T5430M

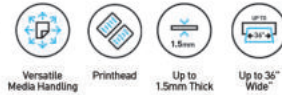

Max Print Width	36 inch wide (914 mm)
Print Head	PrecisionCore TFP with VSDT and Auto Head Alignment
Max Resolution	2400 dpi x 1200 dpi
Min Droplet Size	4.0 pl
Ink System	Epson Ultrachrome® XD2
Type	All-Pigment Aqueous
Colours	C+M+Y+K
Cartridge Size	CMYK 110/350ml
Scan Technology	Contact Image Sensor (CIS) with RGB filters
Light Source	Dual Low Angle
Feed System	Sheet pass-through
Max Resolution	600 dpi
Max Scan Speed	11.43 cm/s or 4.5 ips (Colour) 19.05 cm/s or 7.5 ips (Mono)
Max Copy Speed	38 sec per A1 sheet mono 44 sec per A1 sheet colour
Print Speed (A1 Sheet)	CAD A1 : 22 sec
Paper Size	Single roll top loaded spindle, 2" core, 3" core for plain paper, 0.08 to 0.3 mm thick, 254-914 mm wide, 170 mm max diameter, max weight 12kg
Interface	USB 3.0 & Ethernet 10Base-T / 100Base-TX / 1000Base-T, Wi-Fi, Wi-Fi Direct, Air Print
OS Compatibility	Windows 10 / 8.1 / 8 / 7 / Vista / XP, Mac OS x 10.6.8 or later
Memory	1 GB
Power Consumption	Operating 38W, Standby 13W, Sleep 1.6W
Dimensions (W x D x H)	1,385 x 966 x 1,060 mm
Weight	89 kg

## SURECOLOR SC-T7270/T7270D

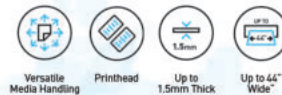

SC-T7270 Single Roll  
SC-T7270D Dual Roll



Max Print Width	44 inch wide (borderless)
Print Head	PrecisionCore TFP with VSDT and Auto Head Alignment
Max Resolution	2,880 dpi x 1,440 dpi
Min Droplet Size	3.5 pl
Ink System	Epson Ultrachrome® XD
Type	All-Pigment Aqueous
Colours	C+Y+M+Mk (Matte Black/Photo Black)
Cartridge Size	110 / 350 / 700 ml
Print Speed	Production Post: 28 sec (360 dpi x 720 dpi, A1 sheet)
Media Thickness	<b>SC-T7270</b> Single top-leading rollfeed, Manual top-loading sheet fed Manual front-loading thick board feed, Rolls (0.08mm-0.5mm thickness; max roll diameter 150mm) = 254 - 1118mm width, Sheets (0.08mm - 0.8mm thickness) = 210 - 1118 mm, Thickness board = 0.8 - 1.5mm <b>SC-T7270D</b> Two automatic roll feeds (top-and front loading), Manual top-loading sheet fed, Manual front-loading thick board feed Rolls (0.08mm-0.5mm thickness; max roll diameter 150mm) = 254 - 1118 mm width, Sheets (0.08mm - 0.8mm thickness) = 210 - 1118 mm, Thickness board = 0.8 - 1.5mm
Scan Performance (MFP Configurations Only)	Max Scan Speed: 146 mm/s @ 200 dpi colour/greyscale 77 mm/s @ 300 dpi colour/greyscale 57 mm/s @ 360 dpi colour/greyscale 15 mm/s @ 600 dpi colour/greyscale
Interface	USB 2.0 & Ethernet 10Base-T/100Base-TX / 1000Base-T
Memory	1 GB, Optional 320 GB HDD
Power Consumption	65W Operating, 17W Ready, 3W Sleep
Dimensions (W x D x H)	1608 x 1128 x 1070 mm (SC-T7270) 1742 x 1321 x 1074 mm (SC-T7270D)
Weight	92kg (SC-T7270), 133 kg (SC-T7270D)

# BUSINESS INKJET PRINTER

## Business Inkjet Printer Consumable

### MATERIAL CODE DESCRIPTION



**WF-C5390 & WF-C5890**  
 C13T11F100 STANDARD CAPACITY BLACK INK PACK  
 C13T11F200 STANDARD CAPACITY CYAN INK PACK  
 C13T11F300 STANDARD CAPACITY MAGENTA INK PACK  
 C13T11F400 STANDARD CAPACITY YELLOW INK PACK  
 C13T11H100 HIGH CAPACITY BLACK INK PACK



**WF-C579R**  
 C13T01C100 WF-C579R BK / Standard  
 C13T01C200 WF-C579R C / Standard  
 C13T01C300 WF-C579R M / Standard  
 C13T01C400 WF-C579R Y / Standard  
 C13T01D100 WF-C579R BK / Large  
 C13T01D200 WF-C579R C / Large  
 C13T01D300 WF-C579R M / Large  
 C13T01D400 WF-C579R Y / Large



**L6550/L6580/L15160/L15180/M15180**  
 C13T06G199 008 CAHILL/CAVANI, BLACK 127ML (EIN)  
 C13T06G299 008 CAHILL/CAVANI, CYAN 70ML (EIN)  
 C13T06G399 008 CAHILL/CAVANI, MAGENTA 70ML (EIN)  
 C13T06G499 008 CAHILL/CAVANI, YELLOW 70ML (EIN)



**WF-C878R & WF-C879R**  
 C13T05A100 WF-C878R/C879R INK PACK, BLACK/STD  
 C13T05A200 WF-C878R/C879R INK PACK, CYAN/STD  
 C13T05A300 WF-C878R/C879R INK PACK, MAGENTA/STD  
 C13T05A400 WF-C878R/C879R INK PACK, YELLOW/STD  
 C13T05B100 WF-C878R/C879R INK PACK, BLACK/LARGE  
 C13T05B200 WF-C878R/C879R INK PACK, CYAN/LARGE  
 C13T05B300 WF-C878R/C879R INK PACK, MAGENTA/LARGE  
 C13T05B400 WF-C878R/C879R INK PACK, YELLOW/LARGE



**AM-C4000**  
 C13T08F100 INK CARTRIDGE, BLACK  
 C13T08F200 INK CARTRIDGE, CYAN  
 C13T08F300 INK CARTRIDGE, MAGENTA  
 C13T08F400 INK CARTRIDGE, YELLOW

**AM-C5000/6000**  
 C14T08E100 INK CARTRIDGE, BLACK  
 C14T08E200 INK CARTRIDGE, CYAN  
 C14T08E300 INK CARTRIDGE, MAGENTA  
 C14T08E400 INK CARTRIDGE, YELLOW



**WF-C20750**  
 C13T02S100 INK CARTRIDGE, BK, 75PPM  
 C13T02S200 INK CARTRIDGE, C, 75PPM  
 C13T02S300 INK CARTRIDGE, M, 75PPM  
 C13T02S400 INK CARTRIDGE, Y, 75PPM

**WF-C21000**  
 C13T02Y100 INK CARTRIDGE, BK, 100PPM  
 C13T02Y200 INK CARTRIDGE, C, 100PPM  
 C13T02Y300 INK CARTRIDGE, M, 100PPM  
 C13T02Y400 INK CARTRIDGE, Y, 100PPM



**WF-M21000**  
 C13T04Q100 BLACK INK, MONO LIJ

# BUSINESS INKJET PRINTER

## Business Inkjet Printer Consumable

MATERIAL CODE	DESCRIPTION
---------------	-------------



**T5430/T3430**  
 C13T41D200 CYAN 350ML  
 C13T41D300 MAGENTA 350ML  
 C13T41D400 YELLOW 350ML  
 C13T41D500 BLACK 350ML  
 C13T41Q200 CYAN 110ML  
 C13T41Q300 MAGENTA 110ML  
 C13T41Q400 YELLOW 110ML  
 C13T41Q500 BLACK 110ML



**C-T3130/SC-T3130N/SC-T5130/ SC-T3130M/SC-T5130M**

C13T40A100 BLACK INK CARTRIDGE 50ML  
 C13T40A200 CYAN INK CARTRIDGE 26ML  
 C13T40A300 MAGENTA INK CARTRIDGE 26ML  
 C13T40A400 YELLOW INK CARTRIDGE 26ML  
 C13T40B100 BLACK INK CARTRIDGE 80ML  
 C13T40B200 CYAN INK CARTRIDGE 50ML  
 C13T40B300 MAGENTA INK CARTRIDGE 50ML  
 C13T40B400 YELLOW INK CARTRIDGE 50ML



**T3130X**  
 C13T49K100 BLACK 140ML  
 C13T49K200 CYAN 140ML  
 C13T49K300 MAGENTA 140ML  
 C13T49K400 YELLOW 140ML



**T3270/T5270/T7270**  
 C13T692100 PHOTOBLOCK 110ML  
 C13T692200 CYAN 110ML  
 C13T692300 MAGENTA 110ML  
 C13T692400 YELLOW 110ML  
 C13T692500 MATTE BLACK 110ML  
 C13T693100 PHOTOBLOCK 350ML  
 C13T693200 CYAN 350ML  
 C13T693300 MAGENTA 350ML  
 C13T693400 YELLOW 350ML  
 C13T693500 MATTE BLACK 350ML  
 C13T694100 PHOTOBLOCK 700ML  
 C13T694200 CYAN 700ML  
 C13T694300 MAGENTA 700ML  
 C13T694400 YELLOW 700ML  
 C13T694500 MATTE BLACK 700ML



**SC-T3435/SC-T5435**

C13T41Q500 BLACK INK CARTRIDGE 110ML  
 C13T41Q200 CYAN INK CARTRIDGE 110ML  
 C13T41Q300 MAGENTA INK CARTRIDGE 110ML  
 C13T41Q400 YELLOW INK CARTRIDGE 110ML  
 C13T41D500 BLACK INK CARTRIDGE 350ML  
 C13T41D200 CYAN INK CARTRIDGE 350ML  
 C13T41D300 MAGENTA INK CARTRIDGE 350ML  
 C13T41D400 YELLOW INK CARTRIDGE 350ML  
 C13T41C500 BLACK INK CARTRIDGE 700ML  
 C13T41C200 CYAN INK CARTRIDGE 700ML  
 C13T41C300 MAGENTA INK CARTRIDGE 700ML  
 C13T41C400 YELLOW INK CARTRIDGE 700ML



**SC-T3730/5730/7730/D**

C13T51F200 CYAN IC (110 ML)  
 C13T51F800 MATTE BLACK IC (110ML)  
 C13T51F300 MAGENTA IC (110ML)  
 C13T51F100 PHOTOBLOCK IC (110ML)  
 C13T51FF00 RED IC (110ML)  
 C13T51F400 YELLOW IC (110ML)  
 C13T50Y200 CYAN IC (350ML)  
 C13T50Y800 MATTEBLACK IC (350ML)  
 C13T50Y300 MAGENTA IC (350ML)  
 C13T50Y100 INK PHOTOBLOCK IC (350ML)  
 C13T50YF00 RED IC (350ML)  
 C13T50Y400 YELLOW IC (350ML)  
 C13T50R200 CYAN IC (700ML)  
 C13T50R800 MATTEBLACK IC (700ML)  
 C13T50R300 MAGENTA IC (700ML)  
 C13T50R100 PHOTOBLOCK IC (700ML)  
 C13T50RF00 RED IC (700ML)  
 C13T50R400 YELLOW IC (700ML)





[www.epson.co.id/largeformat](http://www.epson.co.id/largeformat)

# COMMERCIAL & INDUSTRIAL PRINTER

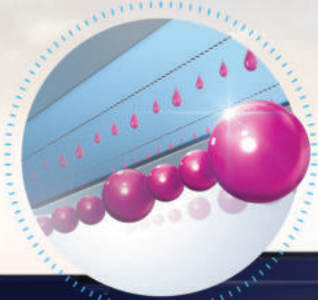

# COMMERCIAL & INDUSTRIAL PRINTER

## MENGAPA MEMILIH EPSON PRINTER ?

Epson large format printer memastikan hasil warna yang luar biasa sehingga menjadi pilihan yang tepat untuk mendukung berbagai bisnis Anda mulai dari Advertising, fashion, retail dan photography.

### Print head Epson Micro Piezo™

Print head Epson Micro Piezo™ Thin Film Piezo yang khusus dikembangkan untuk printer Large Format Epson, memiliki performa dan daya tahan tinggi dengan 360 micro-fine nozzles untuk setiap warnanya, memberikan bentuk dot (titik) yang sempurna. Teknologi ini menggunakan Variable-Sized Droplet Technology (VSDT) untuk memproduksi butiran tinta dalam berbagai ukuran sampai sekecil 3.5 pico-litres (pl) yang mampu menghemat waktu mencetak dan mengoptimalkan kualitas. Print head juga dilengkapi dengan Ink-Repelling Coating, lapisan pada permukaan print head untuk mengurangi kemungkinan terjadinya penyumbatan pada tinta. Teknologi printhead yang berupa lapisan tipis unik piezo (TFP) yang memadukan teknologi komponen superior dengan teknologi fabrikasi Micro-Electro-Mechanical-System (MEMS) yang berpresisi tinggi. Hasilnya adalah kecepatan cetak dan mutu gambar yang tinggi untuk pemakaian di berbagai kegiatan usaha dan industri.



### Epson LUT (Look Up Table) Technology

Dengan teknologi Epson LUT, hasil cetak printer format besar Epson menampilkan gradasi halus, butiran tampak berkurang dan warna tidak dapat berubah, menjadikan hasil cetak indah dan gambar berdefinisi tinggi.

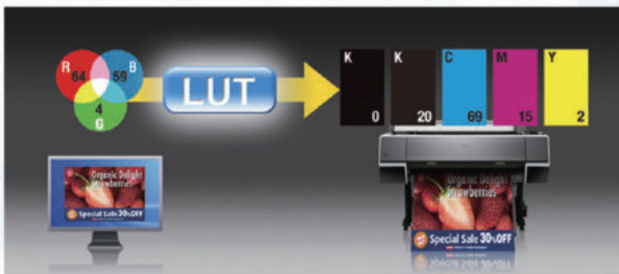

# COMMERCIAL & INDUSTRIAL PRINTER

**P**  
P-Series

SurePress Label Printers

## SUREPRESS SP-L6534VW



<b>Print Technology</b>	PrecisionCore linehead inkjet technology
<b>Max Print Resolution</b>	600 x 1200 dpi
<b>Substrate Width</b>	80mm to 340mm
<b>Substrate Type</b>	Adhesive Paper, Adhesive Film, Single Layer Paper, Single Layer Film
<b>Substrate Thickness</b>	80 to 320 microns
<b>Substrate Treatment</b>	Corona Treatment, Static Ionizer, UV Curing Lamp
<b>Unwinder Capacity</b>	600mm dia / 100kg weight / 1,000m length
<b>Ink Type</b>	UV Curable Inks
<b>Ink Cartridges</b>	Black, Cyan, Magenta, Yellow, Digital Varnish, White, Storage liquid
<b>Print Speed</b>	Productivity Mode: 50m/min, Standard Mode: 30m/min, High Density Mode: 15m/min, Reverse White Mode: 7.6m/min
<b>Dimensions</b>	4250 (W) x 2290 (D) x 2520 (H) mm
<b>Weight</b>	2640 kg

**Available with Orange Ink**

## SUREPRESS SP-L4733AW



<b>Model No</b>	SurePress L 4733AW
<b>Printing Technology</b>	Epson MicroPiezo inkjet technology
<b>Ink Type</b>	SurePress AQ Ink T4 (SurePress AQ)
<b>Ink cartridge</b>	Black, Uncoated Black, Cyan, Magenta, Yellow, Orange, Green, Over print liquid, Moisture liquid (AW model only: White, Storage liquid)
<b>Image size</b>	315.2mm x 914.4mm
<b>Print speed</b>	Up to 8.2 meter per minute *
<b>Substrate thickness</b>	80 to 320 µm
<b>Substrate width</b>	80 to 334mm Adjustable to support any width in this range
<b>Substrate support</b>	Standard self adhesive label substrate, Semi gloss, gloss and matte paper stock, BOPP, PET, Yupo and pre laminated film
<b>Unwinder capacity (Max.)</b>	100kg weight / 1,000m length, 600mm diameter with 76mm (3") inner core
<b>Dimensions of Press (WxDxH)</b>	3950 x 1,910mm x 2,020mm
<b>Dimensions of Press and Rewinder (WxDxH)</b>	5100 x 1,910mm x 2,020mm
<b>Weight of Press</b>	Approximately 1870kg(TBD) including rewriter
<b>Weight of Rewinder</b>	Approximately 180kg
<b>Network connectivity</b>	Ethernet 1000 base T or higher is recommended
<b>Power requirements</b>	Input voltage range: Rated voltage 10% (180 220V) Rated voltage: AC (3 phases 3 lines) 200V
<b>Temperature (Operating)</b>	18 - 28 derajat celcius
<b>Relative Humidity (Operating)</b>	35 - 55% (no condensation)
<b>Max. sound level (Operating)</b>	75dB or less (excluding the alarm sound)



EPSON

GO  
BIG



ON THE  
DETAILS.

## COMMERCIAL &amp; INDUSTRIAL PRINTER

**B** | Surecolor Bulk Series

**SURECOLOR  
SC-B6070**
Versatile  
Media HandlingUp to 44"  
thickUp to 44"  
Wide\*

Ethernet

**Max Print Width  
Print Head**

 1118 mm (44")  
MicroPiezo TFP® Print Head with Variable-Sized  
Droplet Technology

**Max Resolution  
Min Droplet Size  
Ink System  
Colours**

 720 dpi x 1440 dpi  
3.8pl  
Dye Ink  
Cyan, Magenta, Yellow, Black  
Tank: 1500 ml Pack: 1000 ml

**Print Speed**

 High Speed / Resolution: 360 x 720 dpi /  
Passes: 2 = 30.6 m<sup>2</sup>/h  
Production 1 / Resolution: 720 x 720 dpi /  
Passes: 3 = 22.6 m<sup>2</sup>/h  
Production 2 / Resolution : 720 x 1440 dpi / Passes:  
4 = 15.8 m<sup>2</sup>/h  
High Quality / Resolution: 720 x 1440 dpi / Passes:  
7/8 = 6.2 m<sup>2</sup>/h

**Paper Size**

 Maximum Paper Width: 1118 mm (44")  
Minimum Cut-sheet Size: 254 mm (10.0")  
Hi-Speed USB 2.0, Ethernet 100BASE-TX /  
1000 BASE-T

**Interface**
**OS Compatibility**

 Windows Vista / 7 / 8 / 8.1 / 10 (64bit) or later, Mac  
OS 10.6 or later

**Memory**

512 MB Network: 128 MB

**Power Consumption**

 Operating: Approx. 65W  
Standby: Approx. 20W  
Sleep: Approx. 3W (Interface is 1000BASE-T)  
Power Off: Less Than 0.4W

**SURECOLOR  
SC-B7070**
Versatile  
Media HandlingUp to 44"  
Up to 1 mmUp to 44"  
Wide\*

Ethernet

**Max Print Width  
Print Head**

 1625.6 mm (64")  
MicroPiezo TFP® Print Head with Variable-Sized  
Droplet Technology

**Max Resolution  
Min Droplet Size  
Ink System  
Colours**

 720 dpi x 1440 dpi  
5.2pl  
Dye Ink  
Cyan, Magenta, Yellow, Black  
Tank: 1500 ml Pack: 1000 ml

**Print Speed**

 High Speed / Resolution: 360 x 720 dpi /  
Passes: 2 = 30.6 m<sup>2</sup>/h  
Production 1 / Resolution: 720 x 720 dpi /  
Passes: 3 = 22.6 m<sup>2</sup>/h  
Production 2 / Resolution : 720 x 1440 dpi / Passes:  
4 = 15.8 m<sup>2</sup>/h  
High Quality / Resolution: 720 x 1440 dpi / Passes:  
7/8 = 6.2 m<sup>2</sup>/h

**Paper Size**

 Maximum Paper Width: 1118 mm (44")  
Minimum Cut-sheet Size: 254 mm (10.0")  
Hi-Speed USB 2.0, Ethernet 100BASE-TX /  
1000 BASE-T

**Interface**
**OS Compatibility**

 Windows Vista / 7 / 8 / 8.1 / 10 (64bit) or later, Mac  
OS 10.6 or later

**Memory**

512 MB Network: 128 MB

**Power Consumption**

 Operating: Approx. 65W  
Standby: Approx. 20W  
Sleep: Approx. 3W (Interface is 1000BASE-T)  
Power Off: Less Than 0.4W

# COMMERCIAL & INDUSTRIAL PRINTER

## SURECOLOR SC-B9070



**Max Print Width  
Print Head**

max. 1,616 mm  
Dual PrecisionCore™ TFP® Printhead  
2880 dpi x 1440 dpi

**Max Resolution  
Min Droplet Size  
Ink System  
Colours**

4,1 pl  
New Formula Dye Ink  
Epson Dye Ink  
Cyan, Magenta, Yellow, Black

**Print Speed**

Pouch: 1,000 ml; CISS Tank: 1,500 ml  
Draft - 1 Pass: Up to 100 m<sup>2</sup>/h (360 x 720 dpi)  
Speed - 4 Pass: Up to 31 m<sup>2</sup>/h (720 x 720 dpi)  
Production - 6 Pass: Up to 20.5 m<sup>2</sup>/h (720 x 1440 dpi)  
Quality - 8 Pass: Up to 15.3 m<sup>2</sup>/h (720 x 1440 dpi)  
High Quality - 12 Pass: Up to 8.6 m<sup>2</sup>/h (2880 x 1440 dpi)  
Max Quality - 16 Pass: Up to 6.7 m<sup>2</sup>/h (2880 x 1440 dpi)



**Paper Size**

Max Quality - 24 Pass: Up to 4.8 m<sup>2</sup>/h (2880 x 1440 dpi) [Backlit Film]  
Media Width: 300 to 1,626 mm (64 inch)  
Media Thickness: Up to 1 mm

**Interface**

Hi-Speed USB 2.0, Ethernet 100BASE-TX / 1000BASE-T

**OS Compatibility  
Memory  
Power Consumption**

Windows Vista / 7 / 8 / 8.1 / 10 (64bit) or later  
512 MB Main + 128 MB Network  
Operating: Approx. 440 W (=75 W + 360 W)  
Ready: Approx. 320 W (=34 W + 280 W)  
Sleep: Approx. 14 W (=13 W + 0.5 W)  
Power off: Approx. 1.1 W (=0.6 W + 0.5 W)

## F F-Series

### Surecolor Fabric Series

## SURECOLOR SC-F2130

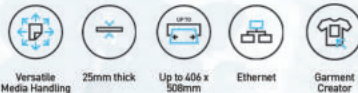

**Max Print Width  
Print Head  
Max Resolution  
Min Droplet Size  
Ink System  
Colours  
Cartridge Size  
Print Speed**

Standard & Medium Grooved Platen: 356 x 406 mm  
PrecisionCore™ TFP  
1440 dpi x 1440 dpi

12 pl  
Epson Ultrachrome® DG  
CYMKWW  
600ml

4 Colour Configuration; High Speed: 9 sec, Production: 15 sec, High Quality: 27 sec, 5 Colour Configuration  
Fast Production: 15 sec (Colour Only), 27 sec (White Only), 52 sec (White + Colour), Production: 27 sec (Colour Only), 49 sec (White Only), 87 sec (White + Colour)  
Quality: 50 sec (Colour Only), 111 sec (White Only), 171 sec (White + Colour)

**Interface**

Rear High Speed USB 2.0 & Ethernet  
100Base-T/1000Base-T

**OS Compatibility  
Memory  
Power Consumption  
Dimension  
Weight**

Windows & Mac Compatible  
512 MB Main + 128MB Network  
55W Operating, 10W Sleep  
985 W x 490 H x 1,425 mm D  
84kg



# COMMERCIAL & INDUSTRIAL PRINTER

## F-Series Surecolor Fabric Series

### SURECOLOR SC-F3030

Dual  
Print HeadBulk Ink  
SolutionUp to 29.5 mm  
thicknessSelf Repair  
FunctionDirect To  
Garment

Max Print Width	406 x 508 mm (using optional Large Platen)
Print Head	PrecisionCore Micro TFP print head x 2
Max Resolution	1,200 x 1,200 dp
Min Droplet Size	12.1 pl
Ink System	Epson Ultrachrome® DG
Colours	CYMKWW
Cartridge Size	1500ml
Print Speed	Fast 14s (Colour Only), 26s (White + Colour) Production: 21s (Colour Only), 40s (White + Colour) Quality: 36s (Colour Only), 47s (White + Colour) High Quality: 48s (Colour only), 70s (White + Colour)
Interface	Rear High Speed USB 2.0 & Ethernet 100Base/T1000 Base- T/100 Base Front panel USB for file storage &Uploading (FAT32 format)
OS Compatibility	Windows & Mac Compatible.
Memory	4GB
Power Consumption	168 W Operating, 111W Ready, 20W Sleep

### SURECOLOR SC-F130

Genuine  
WarrantyWiFi  
ConnectCompact  
DesignOutstanding  
Print Quality

Paper Width	A4, LTR, Legal
Printhead	PrecisionCore Micro TFP Printhead
Max. Resolution	600 x 1,200 dpi
Ink Type	Dye Sublimation Transfer Ink
Colours	Cyan, Magenta, Yellow, Black
Paper Path	Friction Feed
Print Speed	65 seconds (Default)
Interfaces	Hi-Speed USB *2, Ethernet (10BASE-T / 100BASE-TX), Wi-Fi (IEEE 802.11 b/g/n)
Memory	132 Kbyte (Input Buffer Memory)
Voltage	AC 220 - 240V (withstand voltage AC 400V)
W x D x H	375x503x187mm
Frequency	50/60 Hz
Power Consumption	Operating: Aprox. 13W Ready: Aprox. 4.1W Sleep: Aprox. 0.7W
Weight	Aprox. 4.6 kg (without ink bottle)
Warranty	1 Year/6000 sheets, Whichever comes first

# COMMERCIAL & INDUSTRIAL PRINTER

## SURECOLOR SC-F530



Printer Width	24"
Print Head	PrecisionCore TFP Printhead
Maximum Resolution	2400 x 1200 dpi
Ink System	Epson Genuine Dye-Sublimation Ink
Colours	Cyan, Magenta, Yellow, Black
Print Speed	Production (2 pass), For Fabric: Up to 62 sec / 21 m <sup>2</sup> (600 x 1200 dpi), Production (7 pass): For Fabric & Rigid: Up to 208 sec / 7.5 m <sup>2</sup> (1200 x 1200 dpi), Production (12 pass), For Fabric & Rigid: Up to 350 sec / 4.5 m <sup>2</sup> (2400 x 1200 dpi)
Interface	USB 2.0 Hi-speed, Ethernet 100BASE-TX / 1000BASE-T
OS Compatibility	Windows 10 / 8.1 / 8 / 7 / Vista / XP, Mac OSx10.6.8 or later
Memory	1 GB
Power Consumption	Operating: Approx. 22W, Ready: Approx. 8W Sleep: Approx. 1.6W, Power Off (Stand by): Approx. 0.2W
Dimension	Storage (W x H x D): 970 mm x 245 mm x 577 mm Printing (W x H x D): 970 mm x 245 mm x 811 mm
Weight	29kg

## SURECOLOR SC-F531



Max. Print Width	24 inch
Printhead	PrecisionCore TFP" Printhead
Max. Resolution	2,400 x 1,200 dpi
Min. Droplet Size	4.0pl
Ink Type	Epson Genuine Dye-SUblimat ion Ink
Colours	4 Colours - Cyan, Flourescent Pink, Flourescent Yellow Black
Cartridge Size	Cyan, Magenta, Yellow: 26ml, 50ml ; Black: 50ml , 80ml
Print Speed	Production (2 pass), For Fabric: Up to 62 sec / 21 m <sup>2</sup> (600 x 1200 dpi) ; Production (7 pass): For Fabric & Rigid: Up to 208 sec / 7.5 m <sup>2</sup> (1200 x 1200 dpi) Production (12 pass), For Fabric & Rigid: Up to 350 sec / 4.5 m <sup>2</sup> (2400 x 1200 dpi)
Interface	Super-Speed USB 100BASE-TX / 1000BASE-T / IEEE802.11 b/g/n
Memory	1 GB
Power Consumption	Ready: Approx. 8W; Sleep: Approx. 1.6 W Operating: Approx. 28W; Power Off: Approx 0.2W
Dimensions	970 x 505 x 230 (WxDxH)
Weight	29 kg (without ink cartridges)

# COMMERCIAL & INDUSTRIAL PRINTER

## F Surecolor Fabric Series

### SURECOLOR SC-F7270



Max Print Width	64 inches (1625.6mm)
Print Head	10 channel PrecisionCore™ TFP with VSDT
Max Resolution	720 dpi x 1440 dpi
Ink System	Epson Ultrachrome® DS
Type	Dye Sublimation
Colours	C+Y+M+Bk / C+Y+M+Hdk
Cartridge Size	4 x 1.5L
Print Speed	Normal Mode Draft: 58.9 m <sup>2</sup> /hr 1 Pass 360 x 720dpi Normal Mode Fast Production: 30.3m <sup>2</sup> /hr; 2 Pass 720 x 720 dpi; Normal Mode Production 1: 22.2m <sup>2</sup> /hr 3 Pass 720 x 720dpi; HQ Mode Production 1: 13.8m <sup>2</sup> /hr 4 Pass 720 x 720dpi
Paper Size	Thickness 0.08-1mm (75 gsm or greater) Width 300-1625.6 mm
Interface	High Speed USB 2.0 & Ethernet 100Base-T/ 1000Base-T
OS Compatibility	Windows 10 / 8.1 / 8 / 7 (32/64bit) or later (64bit required for Edge Print); Mac OS X 10.7 Lion or later
Memory	512 MB Main + 128MB Network
Power Consumption	460W Operating (heater on), 10W Sleep (heater off, 1000Base-T Interface)
Dimensions (W x D x H)	2620 x 1013 x 1314 mm (W x D x H)
Weight	274kg

### SURECOLOR SC-F6430/H



**NEW  
PRODUCT**



Max Print Width	44 inch
Print Head	PrecisionCore MicroTFP Printhead
Max Resolution	600 x 1,200 dpi
Ink System	<b>SC-F6430</b> UltraChrome DS Ink (Cyan, Magenta, Yellow, High Density Black) <b>SC-F6430H</b> UltraChrome DS 6 Ink (Cyan, Magenta, Yellow, High Density Black, Light Cyan, Light Magenta, Fluorescent Yellow, Fluorescent Pink, Orange, Violet)
Type	Dye Sublimation
Ink Capacity	4 x 1.5L Continuous Ink Supply System (CISS)
Refill	1.6 L
Paper Size	Thickness Up to 0.5 mm Width 254 mm to 1,118 mm (10" to 44")
Interface	Super Speed USB, 100BASE-TX/1000BASE-T
Memory	1 GB
Power Consumption	80W Operating, 36W Ready, 19W Sleep
Weight	<b>SC-F6430</b> With Take Up Reel: Approx. 133 kg Without Take Up Reel: Approx. 120 kg <b>SC-F6430H</b> With Take Up Reel: Approx. 140 kg Without Take Up Reel: Approx. 127 kg

# COMMERCIAL & INDUSTRIAL PRINTER

## SURECOLOR SC-F9430



Max Print Width 64 inch (1625.6 mm)  
 Print Head DUAL Epson PrecisionCore™ TFP  
 Max Resolution 720 dpi x 1440 dpi  
 Min Droplet Size 4 pl  
 Ink System Epson Ultrachrome® DS  
 Type Epson Sublimation  
 Colours Dual CYMHD  
 Cartridge Size 8 / 10 x 1.5L Continuous Ink Supply System (CISS)  
 Refill 1.1L CYMHDk  
 Print Speed

4c Fast Fabric Production:  
 360 x 720 dpi (2 Pass) 60.1 m2/hr  
 4c Standard Fabric Production :  
 720 x 720 dpi (3 Pass) 44.1 m2/hr  
 4c HQ Standard Rigid Production :  
 720 x 720 dpi (6 Pass) 20.7 m2/hr  
 6c Standard Fabric Production (F9430H only):  
 720 x 1440 dpi (6 Pass) 21.9m2/hr  
 6c HQ Standard Rigid Production (F9430H only):  
 720 x 1440 dpi (12 Pass) 10.6m2/hr  
 300 - 1626 mm wide x 250 mm diameter, 2"/ 3" core  
 High Speed USB 2.0  
 Ethernet 100Base-T / 1000Base-T  
 Windows 10, 8/8.1, 7 SP1 64bit or later  
 512 MB Main + 128 MB Network  
 570W Operating / Standby 340W / 14W Sleep  
 (1000BASE-T)

Paper Size  
Interface

OS Compatibility  
Memory  
Power Consumption

## SURECOLOR SC-F9430H



Max Print Width 64 inch (1625.6 mm)  
 Print Head DUAL Epson PrecisionCore™ TFP  
 Max Resolution 720 dpi x 1440 dpi  
 Min Droplet Size 4 pl  
 Ink System Epson Ultrachrome® DS6  
 Type Epson Sublimation  
 Colours Dual CYMHDk + Single Fp & Fy (F9430H)  
 Cartridge Size 8 / 10 x 1.5L Continuous Ink Supply System (CISS)  
 Refill 1.1L CYMHDk  
 Print Speed

4c Fast Fabric Production:  
 360 x 720 dpi (2 Pass) 60.1 m2/hr  
 4c Standard Fabric Production :  
 720 x 720 dpi (3 Pass) 44.1 m2/hr  
 4c HQ Standard Rigid Production :  
 720 x 720 dpi (6 Pass) 20.7 m2/hr  
 6c Standard Fabric Production (F9430H only):  
 720 x 1440 dpi (6 Pass) 21.9m2/hr  
 6c HQ Standard Rigid Production (F9430H only):  
 720 x 1440 dpi (12 Pass) 10.6m2/hr  
 300 - 1626 mm wide x 250 mm diameter, 2"/ 3" core  
 High Speed USB 2.0  
 Ethernet 100Base-T / 1000Base-T  
 Windows 10, 8/8.1, 7 SP1 64bit or later  
 512 MB Main + 128 MB Network  
 570W Operating / Standby 340W / 14W Sleep  
 (1000BASE-T)

Paper Size  
Interface

OS Compatibility  
Memory  
Power Consumption

# COMMERCIAL & INDUSTRIAL PRINTER

## F Surecolor Fabric Series

### SURECOLOR SC-F10030



Max Media Width	76 inch (1950mm)
Print Head	FOUR 4.7" Epson PrecisionCore™ TFP
Nozzle Configuration	800 x 4 per head/colour
Maximum Resolution	1200 x 1200dpi
Min Droplet Size	Dye Sublimation Epson Ultrachrome® DS
Colours	CYM +HDk
Supply	DUAL Continuous Ink Supply System (CISS) with auto hot-swap
Refills	Choice of 3L or 10L box type PERFORMANCE
Max Quality	1200 x 1200dpi*4 (9 Pass) 29.3m <sup>2</sup> /hr
Size	300-1950mm wide, 250mm max diameter/ 60Kg max weight
Thickness	0.04-1mm
Control Panel	9" Colour Touch LCD
Interface	High Speed USB 3.0, Ethernet 1000Base-T
Memory	155GBI
Power Supply	2 x 16A, 240V, 50/60 Hz AC
Power Consumption	3.9kW Operating / 221W Sleep / 9.6W Off
Dimensions (W x D x H)	1303mm x 2886mm x 4607mm, 683Kg (without media holders or ink)
Printer	CISS: 877 x 556 x 541mm, 53kg (no ink)
Operational Space (W x D x H)	5.6 x 3.3 x 2.0m recommended
Weight	736kg (without ink)

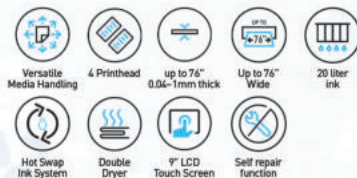

### SURECOLOR SC-F10030H



Max Media Width	76 inch (1950mm)
Print Head	six 4.7" Epson Precision Core tm TFP
Colours	CMY + HDk + Fluorescent Pink Fluorescent Yellow or Light Magenta Light Cyan
Dimensions (W x D x H)	196" x 52" x 75" (4,978 mm x 1,303 mm x 1,886 mm)
Weight	Approx. 767 kg (Without ink cartridges)
Printing Dimensions (W x H x D)	5,008 x 1,886 x 1,303 mm
Power Consumption	Operating: Approx. 4.4kw Ready: Approx. 230W Sleep: Approx. 230W Power Off (Stand by): Approx. 9.6 W





# COMMERCIAL & INDUSTRIAL PRINTER

## Direct-To-Fabric Printer

### ML-8000



Print Technology  
Number of Print Head  
Max Resolution

Print Speed

Power Consumption  
Network  
Dimensions

Weight

Print  
Speed

PrecisionCore Inkjet Technology  
8

1,200 x 1,200 dpi (Pigment), 1,200 x 600 dpi  
(Reactive, Acid, Disperse)

Print Speed Square : 290 (300 x 600 dpi, 1 pass)<sup>1</sup> /  
3,122

(300 x 600 dpi, 1 pass)<sup>2</sup>

Print Speed Linear : 193 (300 x 600 dpi, 1 pass)<sup>1</sup> / 634  
(300 x 600 dpi, 1 pass)<sup>2</sup>

12kVA

USB 3.0 Ethernet 1000BASE-T

Printer: 3,700 (W) x 2,690 (D) x 1,830 (H) mm  
(146 x 106 x 72 in), Ink rack (with 10L ink) : 880 (W) x  
960 (D) x 790 (H) mm(35 x 38 x 31 in)

Printer : Approx. 2,150 kg (4,740 lb), Ink rack :  
Approx. 110 kg (243 lb, not including ink)

290 sqm/h (300x600) dpi, 1 pass  
Typical printing speed

155 sqm/h (600x600) dpi, 2 pass

### Monna Lisa Evo Tre 16



Print Technology  
Number of Print Head  
Max Resolution  
Print Speed

Humidity  
Dimension

Electrical  
Weight  
Print Speed

PrecisionCore Inkjet Technology  
16

1,200 x 1,200 dpi

Draft 1 404 m<sup>2</sup>/h

Draft 2 270 m<sup>2</sup>/h

Production 1 221 m<sup>2</sup>/h

Production 2 171 m<sup>2</sup>/h

Production 3 135 m<sup>2</sup>/h

High Quality 1 103 m<sup>2</sup>/h

High Quality 2 79 m<sup>2</sup>/h

High Quality 3 63 m<sup>2</sup>/h

35-80% RH (Condensation)

Printing Machine: Approx. 4,660 (W) x 2,390 (D) x 1,940  
(H) mm

Control Box: 620 (W) x 1,220 (D) x 2,070 (H) mm

Ink Rack: 1,240 (W) x 1,300 (D) x 1,220 (H) mm

Printing Machine: AC 3 Phase 400V 50A (50/60 Hz)

4,650 kg

Maximum Printing Speed

434 sqm/h (300x600) dpi, 1 pass

Typical Printing Speed

239 sqm/h (600x600) dpi, 2 pass

161 sqm/h (900x600) dpi, 3 pass

# COMMERCIAL & INDUSTRIAL PRINTER

## Direct-To-Fabric Printer

### Monna Lisa Evo Tre 32



Print Technology  
Number of Print Head  
Max Resolution  
Print Speed

PrecisionCore Inkjet Technology  
32

1,200 x 1,200 dpi  
Draft 1 692 m<sup>2</sup>/h  
Draft 2 472 m<sup>2</sup>/h  
Production 1 402 m<sup>2</sup>/h  
Production 2 312 m<sup>2</sup>/h  
Production 3 239 m<sup>2</sup>/h  
High Quality 1 187 m<sup>2</sup>/h  
High Quality 2 145 m<sup>2</sup>/h  
High Quality 3 114 m<sup>2</sup>/h

Humidity  
Dimension

35-80% RH (Condensation)  
Printing Machine: Approx. 4,610 (W) x 2,040 (D) x 2,070 (H) mm

Electrical  
Weight  
Print Speed

Control Box: 700 (W) x 1,800 (D) x 2,350 (H) mm  
Ink Rack: 1,240 (W) x 1,300 (D) x 1,220 (H) mm  
Printing Machine: AC 3 Phase 400V 50A (50/60 Hz)  
4,650 kg  
Maximum Printing Speed  
704 sqm/h (300x600) dpi, 1 pass  
Typical Printing Speed  
439 sqm/h (600x600) dpi, 2 pass  
314 sqm/h (900x600) dpi, 3 pass



P-Series

## Surecolor Photographic Series

### SURECOLOR SC-P8530D



Technology

PrecisionCore Inkjet Technology, Variable-Sized Droplet Technology

Max Resolution  
Min Droplet Size  
Ink System  
Ink Capacity  
Colours

2,400 x 1,200 dpi  
3.5pl  
UltraChrome Pro 6 Ink  
350, 700 ml  
Cyan, Magenta, Yellow, Gray, Photo Black, Matte Black

Interface

SuperSpeed USB, 100BASE-TX  
/1000BASE-T/IEEE802.11b/g/n/ac, USB memory stick

Power Consumption

Operating: Approx. 70W, Ready: Approx. 32W,  
Sleep: Approx. 2.0W, Standby: Approx. 0.3W

Dimension (WxHxD)  
Weight

1,848 x 975 x 829 mm  
Approx. 155 kg

# COMMERCIAL & INDUSTRIAL PRINTER

## SURECOLOR SC-P703



Versatile  
Media Handling



Up to  
1.5mm Thick



Ethernet



Wi-Fi

Max Print Wide Technology	13 inch wide
Max Resolution	On-demand ink jet (piezo electric), Variable-Sized Droplet Technology
Min Droplet Size	5760x1440 dpi
Ink System	1.5pl
Colours	UltraChrome PRO10 ink Cyan, Vivid Magenta, Photo Black, Matte Black, Gray, Light Gray, Yellow, Vivid Light Magenta, Light Cyan, Violet
Interface	Wired Connection: Super-Speed USB, 10BASE-T/100BASE-TX, Wireless Connection: Wi-Fi 4
Power Consumption	22 W Operating/ 1.1 W Sleep
Dimension (WxDxH)	Close: 515x368x185 mm, Open: 515x769x420 mm
Weight	Main Unit: Approx. 12.6kg (without ink cartridge)

## SURECOLOR SC-P903



Versatile  
Media Handling



Up to  
1.5mm Thick



Ethernet



Wi-Fi

Max Print Wide Technology	17 inch wide
Max Resolution	On-demand ink jet (piezo electric), Variable-Sized Droplet Technology
Min Droplet Size	5760x1440 dpi
Ink System	1.5pl
Colours	UltraChrome PRO10 ink Cyan, Vivid Magenta, Photo Black, Matte Black, Gray, Light Gray, Yellow, Vivid Light Magenta, Light Cyan, Violet
Interface	Wired Connection: Super-Speed USB, 10BASE-T/100BASE-TX, Wireless Connection: Wi-Fi 4
Power Consumption	24 W Operating/ 1.1 W Sleep
Dimension (WxDxH)	Close: 615x368x199 mm, Open: 615x905x520 mm
Weight	Main Unit: Approx. 14.8kg (without ink cartridge), Option roll unit: 3.1kg

# COMMERCIAL & INDUSTRIAL PRINTER

## P Surecolor Photographic Series

### SURECOLOR SC-P5000

Versatile  
Media HandlingUp to  
1.5mm  
ThickUp to 17"  
Wide

Ethernet



Max Print Width	17 inch (432 mm)
Print Head	PrecisionCore® TFP
Max Resolution	2880 dpi x 1440 dpi
Min Droplet Size	3.5 pl
Ink System	Epson Ultrachrome® HDX
Type	Aqueous all-pigment
Colours	11 (Configurable with Light Light Black OR Violet)
Cartridge Size	200 ml
Print Speed (A2 sheet)	Draft: 360 dpi x 360 dpi 0.5 minutes Normal: 360 dpi x 720 dpi 0.8 minutes Fine: 720 dpi x 720 dpi 1.8 minutes Super Fine: 720 dpi x 1440 dpi 3.6 minutes Super Photo: 2880 dpi x 1440 dpi 7 minutes
Paper Size	8" x 10" (203 x 254 mm) - A2+ (432 x 610 mm) sheets, 203-432 mm wide x 150 mm diameter 3" core / 103 mm diameter 2" core rolls
Interface	High Speed USB 2.0, Ethernet 10Base-T / 100Base-TX / 1000Base-T
OS Compatibility	Mac OS X 10.6.8 or later, Windows 10, 8/8.1, 7, Vista, & Win XP SP1
Memory	256 MB Main and 128 MB Network
Power Consumption	52W Operating / Standby 20W / 5W Sleep (1000BASE-T)
Dimensions (W x D x H)	863 x 766 x 405 mm (Sheet feed & output tray closed)
Weight	52kg (no ink)

### SURECOLOR SC-P6000

Versatile  
Media HandlingUp to  
1.5mm  
ThickUp to 24"  
WideBorderless  
PrintingPrint Quality  
2,880 x 1,440 dpi

Print Head	PrecisionCore™ TFP printhead, Epson Variable-Sized Droplet Technology
Max Resolution	2880x1440 dpi
Min Droplet Size	3.5 pl
Ink System	Epson UltraChrome HD
Colours	Cyan, Photo Black, Matte Black, Vivid Magenta, Yellow, Light Cyan, Vivid Light Magenta, Light Black, Light Light Black
Paper Path	Friction Feed
Roll Dimensions	254mm-610mm, 2inch-core/3inch-core
Paper Size (w) and Thickness	2inch-core: Max 103mm / 3inch-core: Max 150mm 254mm (10") - 610mm (24"): Roll paper 254mm (10") - 610mm (24"): Cut Sheet 0.08-1.50mm
Borderless	254mm (10in.), 300mm (11.8in.), 329mm (13in.), 406mm (16in.), 432mm (17in.), 515mm (20.3in.), 594mm (23in.), 610mm (24in.)
Interface	Hi-Speed USB, 10BASE-T/100BASE-T/1000BASE-T
Dimension (W x D x H)	1,356 x 667 x 1,218 mm
Weight	Approx. 101kg

# COMMERCIAL & INDUSTRIAL PRINTER

## SURECOLOR SC-P6530E



Max Print Width 24 Inch  
 Print Head PrecisionCore Micro TFP printhead  
 Max Resolution 2400 dpl x 1200 dpl  
 Min Droplet Size 3.5pl  
 Ink System Ultra Chrome Pro 6 Ink  
 Colours 6  
 Paper Handling Roll Paper / Friction Head  
 Print Speed 111 Sec, A1 Size Premium Glossy  
 Printer Interface 1000 BASE-T  
 OS Compatibility Mac OS X 10.6.8 or later, Mac os 11 or later  
 Memory 4 GB  
 Power Consumption Operating approx 75W  
 Ready approx 32W  
 Sleep approx 2W  
 Standby approx 0.3W

## SURECOLOR SC-P8000



Print Head PrecisionCore™ TFP printhead, Epson Variable-Sized Droplet Technology  
 Max Resolution 2880x1440 dpi  
 Min Droplet Size 3.5 pl  
 Ink System Epson UltraChrome HD  
 Colours Cyan, Photo Black, Matte Black, Vivid Magenta, Yellow, Light Cyan, Vivid Light Magenta, Light Black, Light Light Black  
 Paper Path Friction Feed  
 Roll Dimensions 254mm-1118mm, 2inch-core/ 3inch-core  
 2inch-core: Max 103mm/ 3inch-core: Max 150mm  
 Paper Size (w) and Thickness 254mm (10") - 1118mm (44"): Roll paper 210mm (A4) - 1118mm (44"): Cut Sheet 0.08-1.50mm  
 Borderless 728mm(29in.), 841mm(A0/33in.), 914mm(36in.), 1118mm (44in.) 728mm (29in.), 841mm A0/33in.), 914mm (36in.), 1118mm (44in.)  
 Interface Hi-Speed USB, 10BASE-T/100BASE-T/1000BASE-T  
 Dimension (W x D x H) 1,864 x 667 x 1,218 mm  
 Weight Approx. 135kg

## SURECOLOR SC-P7530



Max Print Width 24 inch  
 Print Head Micro TFP Printhead  
 Max Resolution 2400 dpi x 1200 dpi  
 Min Droplet Size 3.5 pl  
 Ink System Ultrachrome® Pro12 Pigment Ink  
 Colours 12  
 Paper Handling Roll Paper / Friction Feed  
 Print Speed 97 sec (Level 1) 122 sec (Default) Premium Glossy  
 Photo Paper 170 gsm A1 size/ISO  
 Super Speed USB, 100 BASE - TX / 1000 BASE - T  
 OS Compatibility Mac OS X 10.6.8 or later, Windows XP / Vista / 7 / 8 / 8.1 (32/64bit) or later  
 Memory 2 GB  
 Power Consumption Operating : Approx 85 W  
 Ready : Approx 32 W  
 Sleep : Approx 3.4 W  
 Power Off (Standby) : Approx 0.3 W

# COMMERCIAL & INDUSTRIAL PRINTER

**P**  
P-Series

## Surecolor Photographic Series

### SURECOLOR SC-P9530

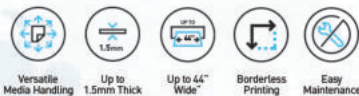

Max Print Width	44 inch
Print Head	Micro TFP Printhead
Max Resolution	2400 dpi x 1200 dpi
Min Droplet Size	3.5 pl
Ink System	Ultrachrome® Pro12 Pigment Ink
Colours	12
Paper Handling	Roll Paper / Friction Feed
Print Speed	219 sec (Level 1) 285 sec (Default) Premium Glossy
Printer Interface	Photo Paper 170 gsm B0 size/ISO USB Interface (Hi-Speed USB/USB, 100 BASE - TX / 1000 BASE - T
OS Compatibility	Mac OS X 10.6.8 or later, Windows XP / Vista / 7 / 8 / 8.1 (32/64bit) or later
Memory	2 GB
Power Consumption	Operating : Approx 110 W Ready : Approx 32 W Sleep : Approx 3.4 W Power Off (Stand by) : Approx 0.3 W

**S**  
S-Series

## Surecolor Signage Series

### SURECOLOR SC-R5030L



Max Print Width	64 inch
Technology	PrecisionCore inkjet technology
Max Resolution	1,200 x 2,400 dpi With 600 x 600 dpi 8 Half Tone layers
Print Speed	Banner Fast Production Vinyl, Paper & Wall Covering - 21m <sup>2</sup> /h (600 x 1200dpi 6 pass) Banner Production Vinyl, Paper & Wall Covering - 15.1m <sup>2</sup> /h (1200 x 1200dpi 9 pass) Textile Production - 9.5m <sup>2</sup> /h (1200 x 1200dpi 14 pass) Film Production - 5.2m <sup>2</sup> /h (1200 x 2400dpi 26 pass)
Ink Type	Resin ink
Colours	Cyan, Magenta, Yellow, Black, Light Cyan, Light Magenta +Optimizer+Mainenance Liquid @ 3000ml
Ink Capacity	USB (Hi-Speed USB), 100BASE-TX/1000BASE-T
Interface	2 GB
Memory	4.6kW Operating/ 220W Ready/ 46W Sleep/ 1.1W Power Off (Stand by)
Power Consumption	Printing : 2,949mm x 1,045mm x 1,774mm Stowed : 2,949mm x 1,045mm x 1,605mm
Dimensions (W x D x H)	449kg
Weight	

# COMMERCIAL & INDUSTRIAL PRINTER

S  
S-Series

Surecolor Signage Series

COMMERCIAL & INDUSTRIAL PRINTER

## SURECOLOR SC-V7000

### Epson 1st UV Flatbed Printer



Technology	MicroPiezo Inkjet Technology (Technology 1) Variable-Sized Droplet Technology (Technology 2)
Print Head	MicroPiezo Printhead
Nozzle Configuration	11,520 nozzles (180 nozzles x 8 lines x 8 head)
Max Resolution	720 x 1,440 dpi
Print Speed	Colour High Speed: 360 x 720 dpi, with speed 43.1 m/h
Curing Method	LED-UV type
Ink Type	UV Curable Ink
Colours	Cyan, Magenta, Yellow, Black, Light Cyan, Light Magenta, Gray, Red, White, Varnish
Ink Capacity	1,000 ml (Ink Bottle)
Max Printing Area	Max. 2,500 x 1,250 mm
Max Media Size	Max. 2,500 x 1,250 mm
Interface	Super-Speed USB (Type-B)
Power Consumption	Operating: Approx. 4.8kW
Dimensions (W x D x H)	4,635mm x 2,768mm x 1,730mm
Weight	1,370 kg (With ink cartridges)

## SD-10

### Digital Colour Spectrophotometer



Technology	Spectroscopic Device
Spectral Range	400 - 700nm
Sampling Interval	Colour Measurement
Photometric Range	10 nm (Interpolation by software)
Light Source	LED (Including UV)
Measurement Conditions	M0: Including UV light component, ISO 13655:2017 measurement condition M0 M1e: D50 - Including UV light component, measurement conditions equivalent to ISO 13655:2017 measurement condition M1 (Measurement conditions held with a radiant power at all wavelengths from 400 to 700 nm, and power ratios in the 300 to 400 nm and 400 to 500 nm regions similar to D50) M2: Without UV, ISO 13655:2017 measurement condition M2
Calibration	White reference built in the sensor cover
Scan Length	400mm
Interfaces	USB Type-C, USB 2.0 Full-Speed BLE Bluetooth Low Energy
Dimensions (W x D x H)	35 x 80 x 80 mm (Shutter Closed) 35 x 80 x 77.6 mm (Shutter Opened)
Weight	Approx. 190g

## COMMERCIAL &amp; INDUSTRIAL PRINTER

## S Surecolor Signage Series

SURECOLOR  
SC-S40670

Max Print Width	64 inch
Print Head	PrecisionCore™ TFP® Printhead
Max Resolution	1440 dpi x 1440 dpi
Min Droplet Size	4.2 pl
Ink System	Epson Ultrachrome® GS3
Type	Eco-Solvent Based
Colours	CMYK
Cartridge Size	4 x 700 ml
Print Speed	Draft: 58.4m <sup>2</sup> /hr (360 dpi x 720 dpi 1 pass) Billboard: 29.4m <sup>2</sup> /hr (720 dpi x 720 dpi 2 pass) Banner: 16.6m <sup>2</sup> /hr (720 dpi x 720 dpi 4 pass) Vinyl: 10.5m <sup>2</sup> /hr (720 dpi x 1440 dpi 6 pass) Film: 3.5m <sup>2</sup> /hr (1440 dpi x 1440 dpi 16 pass)
Paper Size	Single Roll, 2" or 3" core, 250 mm max outer diameter & 45kg max weight Sizing; 300 to 1626 mm wide, 500 mm min length, 1 mm max thickness
Interface	Hi-Speed USB 2.0, 100BASE-TX / 1000BASE-T
RIP Compatibility	Supplied with Epson Edge Print and supports a wide range of 3rd party applications
Memory	512 MB
Power Consumption	480W Operating / 330W Ready/ 12W Sleep
Dimensions (W x D x H)	2,620 x 1,338 x 880 mm (W x H x D)
Weight	279kg

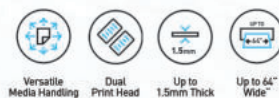
SURECOLOR  
SC-S60670

Max Print Width	64 inch
Print Head	Dual PrecisionCore™ TFP® Printhead
Max Resolution	1440 dpi x 1440 dpi
Min Droplet Size	4.2 pl
Ink System	Epson Ultrachrome® GS3
Type	Eco-Solvent Based
Colours	CMYK
Cartridge Size	2 x 4 x 700 ml
Print Speed	Max Speed: 95.3m <sup>2</sup> /hr (360 dpi x 720 dpi 1 pass) Billboard: 52.3m <sup>2</sup> /hr (720 dpi x 720 dpi 2 pass) Banner: 29.4m <sup>2</sup> /hr (720 dpi x 720 dpi 4 pass) Vinyl: 17.6m <sup>2</sup> /hr (720 dpi x 1440 dpi 6 pass) Film: 6.8m <sup>2</sup> /hr (1440 dpi x 1440 dpi 16 pass)
Paper Size	Single Roll, 2" or 3" core, 250 mm max outer diameter & 45kg max weight Sizing; 300 to 1626 mm wide, 500 mm min length, 1 mm max thickness
Interface	Hi-Speed USB 2.0, 100BASE-TX / 1000BASE-T
RIP Compatibility	Supplied with Epson Edge Print and supports a wide range of 3rd party applications
Memory	512 MB Main + 128 MB Network
Power Consumption	745W Operating / 445W Ready/ 13W Sleep
Dimensions (W x D x H)	2,620 x 1,338 x 972 mm (W x H x D)
Weight	291kg



# COMMERCIAL & INDUSTRIAL PRINTER

## SURECOLOR SC-S60670L

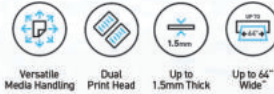

Max Print Width	64 inch
Print Head	Dual PrecisionCore™ TFP® Printhead
Max Resolution	1440 dpi x 1440 dpi
Min Droplet Size	4.2 pl
Ink System	Epson Ultrachrome® GS3
Type	Eco-Solvent Based
Colours	Dual C, M, Y, K (Choice of Standard)
Cartridge Size	2 x 4 x 1500 ml
Print Speed	Max Speed: 95.3m <sup>2</sup> /hr (360 dpi x 720 dpi 1 pass) Billboard: 52.3m <sup>2</sup> /hr (720 dpi x 720 dpi 2 pass) Banner: 29.4m <sup>2</sup> /hr (720 dpi x 720 dpi 4 pass) Vinyl: 17.6m <sup>2</sup> /hr (720 dpi x 1440 dpi 6 pass) Film: 6.8m <sup>2</sup> /hr (1440 dpi x 1440 dpi 16 pass) Single Roll, 2" or 3" core, 250mm max outer diameter & 45kg max weight Sizing; 300 to 1626mm wide, 500mm min length, 1mm max thickness
Interface	High Speed USB & Ethernet 100Base-T / 1000Base-T
RIP Compatibility	Supplied with Epson Edge Print and supports a wide range of 3rd party applications
Memory	512 MB Main + 128 MB Network
Power Consumption	820W
Dimensions (W x D x H)	2,766 x 1,671 x 1,147mm
Weight	331kg w/ink

## SURECOLOR SC-S80670

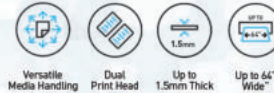

Max Print Width	64 inches
Print Head	DUAL Print Head PrecisionCore™ TFP® Printhead
Max Resolution	1440 dpi x 1440 dpi
Min Droplet Size	4.2 pl
Ink System	Epson Ultrachrome® GS3 & GS3+RED
Type	Eco-Solvent Based
Colours	C, M, Y, K, Lc, Lm, Lk, Or, Rd + (optional) White or Metallic Silver
Cartridge Size	9 x 700 ml + optional 1 x (600 ml Wht or 350 ml Mtl)
Print Speed	Max Speed(9c): 95.1m <sup>2</sup> /hr (360 dpi x 360 dpi 1 pass) Billboard (9c): 31.6m <sup>2</sup> /hr (720 dpi x 720 dpi 4 pass HS) Banner (9c): 18.2m <sup>2</sup> /hr (720 dpi x 720 dpi 6 pass)
Paper Size	Input Format Single Roll with 2" or 3" core, 250 mm max outer diameter & 45kg max weight Sizing 300 to 1626 mm wide, 500 mm min length, 1 mm max thickness
Interface	High Speed USB 2.0 & Ethernet 100Base-T / 1000Base-T
RIP Compatibility	Supplied with Epson Edge Print and supports a wide range of 3rd party applications
Memory	2 GB, Network: 512MB +128MB
Power Consumption	745W Operating/380W Ready/14W Sleep
Dimensions (W x D x H)	2,620 x 1,338 x 880 mm (W x H x D)
Weight	284kg

# COMMERCIAL & INDUSTRIAL PRINTER

## S Surecolor Signage Series

### SURECOLOR SC-S80670L



Max Print Width	64 inches
Print Head	Dual PrecisionCore™ TFP® Printhead
Max Resolution	1440 dpi x 1440 dpi
Min Droplet Size	4.2 pl
Ink System	Epson Ultrachrome® GS3 & GS3+RED
Type	Eco-Solvent Based
Colours	C, M, Y, K, Lc, Lm, Lk, Or, Rd + (optional) White or Metallic Silver
Cartridge Size	9 x 1500 ml + optional 1 x (all color 1500ml) 1500ml White and 500ml Silver Metallic
Print Speed	High Speed: 52.3m <sup>2</sup> /hr (360 dpi x 720 dpi 2 pass)
Paper Handling	Rear Roll Feed / Auto take-up reel
Paper Size	Input Format Single Roll with 2" or 3" core, 250 mm max outer diameter & 45kg max weight Sizing 300 to 1626 mm wide, 500 mm min length, 1 mm max thickness
Interface	High Speed USB & Ethernet 100Base-TX / 1000Base-T
RIP Compatibility	Supplied with Epson Edge Print and supports a wide range of 3rd party applications
Memory	2GB, Network: 128 MB
Power Consumption	640W
Dimensions (W x D x H)	2,766 x 1,671 x 1,090 mm
Weight	326kg w/ink

## D Surelab Photolab Series

### SURELAB SL-D1030



Print Head	Micro Piezo Printhead
Max Resolution	1,440 x 720 dpi
Min Droplet Size	2.5 pl
Ink System	Epson UltraChrome D6r-S Dye Ink
Ink Capacity	250ml
Colours	Cyan, Magenta, Yellow, Light Cyan, Light Magenta, Black
Paper Size	Width: 89mm – 210mm ; Length: 148mm – 297mm
Print Size	Roll: Max. 1,000mm, Min. 50mm / Manual Feed: 1,000mm / Auto Sheet Feeder (ASF): 297mm
Interface	Hi-Speed USB, 100BASE-TX/10BASE-T, IEEE802.11b/g/n, Wi-Fi
OS Compatibility	Windows® 10, Windows® 8.1 for each 32bit/64bit, Macintosh Mac OS X (10.9.5 or later), Mac OS 11.X
Power Consumption	Operating: Approx. 80W / Ready : Approx. 14W / Sleep: Approx. 1.2W / Standby: Approx. 0.2W
Dimensions (W x D x H)	Single-sided Model: 460 x 683 x 359 mm Double-sided Model: 460 x 747 x 441 mm
Weight	Single-sided model: 17.6kg Double-sided model: 23.1kg Main unit: 17.6kg, Duplex Feeder: 5.5kg

# COMMERCIAL & INDUSTRIAL PRINTER

## SURELAB SL-D3000



Print Method	Epson Micro Piezo™ on-demand inkjet with Variable Sized Droplet Technology
Max Resolution	1440 x 1440dpi (Gloss & Lustre) / 720 x 720 dpi (Matte)
Min Droplet Size	1.5pl
Ink System	Epson UltraChrome D6 Ink
Colours	Colours 6 (Cyan, Yellow, Magenta, Black, Light Cyan, Light Magenta) 700 ml per colour
Media Handling	Single Roll Model Dual Roll Model Rear roll up to 305mm / 12" media width Rear roll up to 305mm / 12" media width Front roll up to 210mm / 8" media width Auto-Switch between front / rear rolls
Printer Interface	USB 2.0 Hi-Speed
OS Compatibility	Microsoft Windows XP Professional (SP3), Windows 7 Professional (32- or 64-bit)   2.8 GHz Intel® Core 2 Duo or better
Memory	-
Power Consumption	500W Operating/ 60W Standby

## SURELAB SL-D530



Print Method	Micro Piezo Inkjet Technology with Variable Sized Droplet Technology
Max Resolution	1440 x 720dpi (High Quality) / 720 x 720 dpi (Standard) / 720x360 (Draft)
Max Droplet Size	2.5pl
Ink System	Epson UltraChrome D6r-S Dye Ink
Colours	Colours 6 (Cyan, Magenta, Yellow, Light Cyan, Light Magenta, Black) 70 ml per colour
Media Handling	Auto Sheet Feeder Width: 89mm - 102mm ; Length: 127mm - 152mm Auto Sheet Feeder: 3.5" x 5", 4" x 6" [100 sheets]
Printer Interface	Hi-Speed USB, 100BASE-TX/10BASE-T, IEEE802.11b/g/n
OS Compatibility	Windows®11, Windows®10, Windows®8.1 for each 32bit/64bit, Macintosh Mac OS X (10/9/5 or later), Mac OS 11.X
Memory	0.5 GB
Power Consumption	18W Operating/ 3.8W Ready/1.4W Sleep/ 0.2W Standby

## COMMERCIAL &amp; INDUSTRIAL PRINTER

## Commercial &amp; Industrial Printer Consumable

Order Code	Description	Product	Order Code	Description	Product
C13T738100	Black	SC-B6070	C13T824800	Epson UltraChrome HD 350ml Matte Black Pigment Ink Cartridge	SC-P6000
C13T738200	Cyan		C13T824900	Epson UltraChrome HD 350ml Light Light Black Pigment Ink Cartridge	
C13T738300	Magenta		C13T824100	Epson UltraChrome HD 350ml Photo Black Pigment Ink Cartridge	SC-P8000
C13T738400	Yellow		C13T824200	Epson UltraChrome HD 350ml Cyan Pigment Ink Cartridge	
C13T904100	Black	SC-B9070	C13T824300	Epson UltraChrome HD 350ml Vivid Magenta Pigment Ink Cartridge	
C13T904200	Cyan		C13T824400	Epson UltraChrome HD 350ml Yellow Pigment Ink Cartridge	
C13T904300	Magenta		C13T824500	Epson UltraChrome HD 350ml Light Cyan Pigment Ink Cartridge	
C13T904400	Yellow		C13T824600	Epson UltraChrome HD 350ml Vivid Light Magenta Pigment Ink Cartridge	
C13T725100	Epson UltraChrome DG Ink - Black 600ml	SC-F2130	C13T824700	Epson UltraChrome HD 350ml Light Black Pigment Ink Cartridge	
C13T725200	Epson UltraChrome DG Ink - Cyan 600ml		C13T824800	Epson UltraChrome HD 350ml Matte Black Pigment Ink Cartridge	
C13T725300	Epson UltraChrome DG Ink - Magenta 600ml		C13T824900	Epson UltraChrome HD 350ml Light Light Black Pigment Ink Cartridge	
C13T725400	Epson UltraChrome DG Ink - Yellow 600ml		C13T824100	Epson UltraChrome HD 350ml Photo Black Pigment Ink Cartridge	SC-P7000
C13T725A00	Epson UltraChrome DG Ink - White 600ml		C13T824200	Epson UltraChrome HD 350ml Cyan Pigment Ink Cartridge	
C13S400080	D5 Transfer General Purpose 24 inch Roll	SC-F530	C13T824300	Epson UltraChrome HD 350ml Vivid Magenta Pigment Ink Cartridge	
C13S400079	D5 Transfer General Purpose 17 inch Roll		C13T824400	Epson UltraChrome HD 350ml Yellow Pigment Ink Cartridge	
C13S400081	D5 Transfer General Purpose A3 Roll		C13T824500	Epson UltraChrome HD 350ml Light Cyan Pigment Ink Cartridge	
C13S400082	D5 Transfer General Purpose A4 Roll		C13T824600	Epson UltraChrome HD 350ml Vivid Light Magenta Pigment Ink Cartridge	
C13S400077	D5 Transfer General Purpose A3 Sheet		C13T824700	Epson UltraChrome HD 350ml Light Black Pigment Ink Cartridge	
C13S400078	D5 Transfer General Purpose A4 Sheet		C13T824800	Epson UltraChrome HD 350ml Matte Black Pigment Ink Cartridge	
C12C933151	Stand (24")		C13T824900	Epson UltraChrome HD 350ml Light Light Black Pigment Ink Cartridge	
C12C935701	Roll Feed Spindle (24")		C13T824100	Epson UltraChrome HD 350ml Photo Black Pigment Ink Cartridge	
C13S210057	Maintenance Box		C13T824200	Epson UltraChrome HD 350ml Cyan Pigment Ink Cartridge	
C13S210055	Auto Cutter Spare Blade		C13T824300	Epson UltraChrome HD 350ml Vivid Magenta Pigment Ink Cartridge	
C13T46H200	Epson UltraChrome DS Ink - Cyan 1.1L	SC-F6630	C13T824400	Epson UltraChrome HD 350ml Yellow Pigment Ink Cartridge	
C13T46H300	Epson UltraChrome DS Ink - Magenta 1.1L		C13T824500	Epson UltraChrome HD 350ml Light Cyan Pigment Ink Cartridge	
C13T46H400	Epson UltraChrome DS Ink - Yellow 1.1L		C13T824600	Epson UltraChrome HD 350ml Vivid Light Magenta Pigment Ink Cartridge	
C13T46H800	Epson UltraChrome DS Ink - HD Black 1.1L		C13T824700	Epson UltraChrome HD 350ml Light Black Pigment Ink Cartridge	
C13T741200	Epson UltraChrome DS Ink - Cyan 1L x 6pcs	SC-F7270	C13T824800	Epson UltraChrome HD 350ml Matte Black Pigment Ink Cartridge	
C13T741300	Epson UltraChrome DS Ink - Magenta 1L x 6pcs		C13T824900	Epson UltraChrome HD 350ml Light Light Black Pigment Ink Cartridge	
C13T741400	Epson UltraChrome DS Ink - Yellow 1L x 6pcs		C13T824A00	Epson UltraChrome HDX 350ml Orange Pigment Ink Cartridge	
C13T741X00	Epson UltraChrome DS Ink - HD Black 1L x 6pcs		C13T824B00	Epson UltraChrome HDX 350ml Green Pigment Ink Cartridge	
C13T46H200	Epson UltraChrome DS Ink - Cyan 1.1L	SC-F9340	C13T824D00	Epson UltraChrome HDX 350ml Violet Pigment Ink Cartridge	
C13T46H300	Epson UltraChrome DS Ink - Magenta 1.1L		C13T809000	Epson UltraChrome Pro 700ml Light Grey Pigment Ink Cartridge	SC-P20070
C13T46H400	Epson UltraChrome DS Ink - Yellow 1.1L		C13T809100	Epson UltraChrome Pro 700ml Photo Black Pigment Ink Cartridge	
C13T46H800	Epson UltraChrome DS Ink - HD Black 1.1L		C13T809200	Epson UltraChrome Pro 700ml Cyan Pigment Ink Cartridge	
C13T46H600	Epson UltraChrome DS Ink - FY 1.1L		C13T809300	Epson UltraChrome Pro 700ml Vivid Magenta Pigment Ink Cartridge	
C13T46H500	Epson UltraChrome DS Ink - FP 1.1L		C13T809400	Epson UltraChrome Pro 700ml Yellow Pigment Ink Cartridge	
C13T327100	Photo Black	SC-P407	C13T809500	Epson UltraChrome Pro 700ml Light Cyan Pigment Ink Cartridge	
C13T327200	Cyan		C13T809600	Epson UltraChrome Pro 700ml Vivid Light Magenta Pigment Ink Cartridge	
C13T327300	Magenta		C13T809700	Epson UltraChrome Pro 700ml Dark Grey Pigment Ink Cartridge	
C13T327400	Yellow		C13T809800	Epson UltraChrome Pro 700ml Matte Black Pigment Ink Cartridge	
C13T327700	Red		C13T809900	Epson UltraChrome Pro 700ml Grey Pigment Ink Cartridge	
C13T327800	Matte Black		C13T913100	Epson UltraChrome HD 200ml Photo Black Pigment Ink Cartridge	SC-P5000
C13T327900	Orange		C13T913200	Epson UltraChrome HD 200ml Cyan Pigment Ink Cartridge	
C13T327000	Gloss Optimizer		C13T913300	Epson UltraChrome HD 200ml Vivid Magenta Pigment Ink Cartridge	
C13T763100	Photo Black	SC-P607	C13T913400	Epson UltraChrome HD 200ml Yellow Pigment Ink Cartridge	
C13T763200	Cyan		C13T913500	Epson UltraChrome HD 200ml Light Cyan Pigment Ink Cartridge	
C13T763300	Vivid Magenta				
C13T763400	Yellow				
C13T763500	Light Cyan				
C13T763600	Vivid Light Magenta				
C13T763700	Light Black				
C13T763800	Matte Black				
C13T763900	Light Light Black				
C13T853100	Photo Black	SC-P807			
C13T853200	Cyan				
C13T853300	Vivid Magenta				
C13T853400	Yellow				
C13T853500	Light Cyan				
C13T853600	Vivid Light Magenta				
C13T853700	Light Black				
C13T853800	Matte Black				
C13T853900	Light Light Black				
C13T824100	Epson UltraChrome HD 350ml Photo Black Pigment Ink Cartridge	SC-P6000			
C13T824200	Epson UltraChrome HD 350ml Cyan Pigment Ink Cartridge				
C13T824300	Epson UltraChrome HD 350ml Vivid Magenta Pigment Ink Cartridge				
C13T824400	Epson UltraChrome HD 350ml Yellow Pigment Ink Cartridge				
C13T824500	Epson UltraChrome HD 350ml Light Cyan Pigment Ink Cartridge				
C13T824600	Epson UltraChrome HD 350ml Vivid Light Magenta Pigment Ink Cartridge				
C13T824700	Epson UltraChrome HD 350ml Light Black Pigment Ink Cartridge				

# COMMERCIAL & INDUSTRIAL PRINTER

## Commercial & Industrial Printer Consumable

Order Code	Description	Product	Order Code	Description	Product	
C13T913600	Epson UltraChrome HD 200ml Vivid Light Magenta Pigment Ink Cartridge	SC-P5000	C11CH13402	SC-P9530	SC-P9530	
C13T913700	Epson UltraChrome HD 200ml Light Black Pigment Ink Cartridge		C13T44N100	SC-P9530 PK IC (700ml)		
C13T913800	Epson UltraChrome HD 200ml Matte Black Pigment Ink Cartridge		C13T44N200	SC-P9530 CY IC (700ml)		
C13T913900	Epson UltraChrome HD 200ml Light Light Black Pigment Ink Cartridge		C13T44N300	SC-P9530 VM IC (700ml)		
C13T913A00	Epson UltraChrome HDX 200ml Orange Pigment Ink Cartridge		C13T44N400	SC-P9530 YL IC (700ml)		
C13T913B00	Epson UltraChrome HDX 200ml Green Pigment Ink Cartridge		C13T44V500	SC-P9530 LC IC (350ml)		
C13T913D00	Epson UltraChrome HDX 200ml Violet Pigment Ink Cartridge		C13T44V600	SC-P9530 VL IC (350ml)		
C11CH12402	SC-P7530		SC-P7530	C13T44V700		SC-P9530 LB IC (350ml)
C13T44N100	SC-P7530 PK IC (700ml)			C13T44V800		SC-P9530 MK IC (350ml)
C13T44N200	SC-P7530 CY IC (700ml)			C13T44V900		SC-P9530 LI IC (350ml)
C13T44N300	SC-P7530 VM IC (700ml)	C13T44VA00		SC-P9530 OR IC (350ml)		
C13T44N400	SC-P7530 YL IC (700ml)	C13T44VB00		SC-P9530 GR IC (350ml)		
C13T44N500	SC-P7530 LC IC (700ml)	C13T44VD00		SC-P9530 VI IC (350ml)		
C13T44N600	SC-P7530 VL IC (700ml)	C13T44V100		SC-P9530 P BLACK IC (350ml)		
C13T44N700	SC-P7530 LB IC (700ml)	C13T44V200		SC-P9530 CYAN IC (350ml)		
C13T44N800	SC-P7530 MK IC (700ml)	C13T44V300		SC-P9530 YL IC (350ml)		
C13T44N900	SC-P7530 LI IC (700ml)	C13T44V400		SC-P7530 VM IC (350ML)		
C13T44NA00	SC-P7530 OR IC (700ml)	C13T44V500		SC-P7530 YELLOW IC (350ml)		
C13T44NB00	SC-P7530 GR IC (700ml)	C13T44V600		SC-P7530 LT CYAN IC (350ml)		
C13T44ND00	SC-P7530 VI IC (700ml)	C13T44V700		SC-P7530 VLM IC (350ml)		
C13T44V100	SC-P7530 PK IC (350ml)	C13T44V800		SC-P7530 GREY IC (350ml)		
C13T44V200	SC-P7530 CY IC (350ml)	C13T44V900		SC-P7530 M BLACK IC (350ml)		
C13T44V300	SC-P7530 VM IC (350ml)	C13T44VA00		SC-P7530 LT GREY IC (350ml)		
C13T44V400	SC-P7530 YL IC (350ml)	C13T44VA00		SC-P7530 ORANGE IC (350ml)		
C13T44V500	SC-P7530 LC IC (350ml)	C13T44VB00		SC-P7530 GREEN IC (350ml)		
C13T44V600	SC-P7530 VL IC (350ml)	C13T44VD00		SC-P7530 VIOLET IC (350ml)		
C13T44V700	SC-P7530 LB IC (350ml)	C13T49V110		SC-V7000 Black IC (1000ml)		
C13T44V800	SC-P7530 MK IC (350ml)	C13T49V210		SC-V7000 Cyan IC (1000ml)		
C13T44V900	SC-P7530 LI IC (350ml)	C13T49V310		SC-V7000 Magenta IC (1000ml)		
C13T44VA00	SC-P7530 OR IC (350ml)	C13T49V410		SC-V7000 Yellow IC (1000ml)		
C13T44VB00	SC-P7530 GR IC (350ml)	C13T49V510		SC-V7000 Light Cyan IC (1000ml)		
C13T44VD00	SC-P7530 VI IC (350ml)	C13T49V610		SC-V7000 Light Magenta IC (1000ml)		
C13T44V100	SC-P7530 P BLACK IC (350ml)	C13T49V710		SC-V7000 Gray IC (1000ml)		
C13T44V200	SC-P7530 CYAN IC (350ml)	C13T49V810		SC-V7000 Red IC (1000ml)		
C13T44V300	SC-P7530 YL IC (350ML)	C13T49V910		SC-V7000 White IC (1000ml)		
C13T44V400	SC-P7530 VM IC (350ml)	C13T49VA10		SC-V7000 Varnish IC (1000ml)		
C13T44V500	SC-P7530 YELLOW IC (350ml)	C13T48R100	SC-P8530D PHOTO BLACK 700ML			
C13T44V600	SC-P7530 LT CYAN IC (350ml)	C13T48R200	SC-P8530D CYAN IC 700ML			
C13T44V700	SC-P7530 VLM IC (350ml)	C13T48R300	SC-P8530D MAGENTA IC 700ML			
C13T44V800	SC-P7530 GREY IC (350ml)	C13T48R400	SC-P8530D YELLOW IC 700ML			
C13T44V900	SC-P7530 M BLACK IC (350ml)	C13T48R800	SC-P8530D MATTE BLACK IC 700ML			
C13T44VA00	SC-P7530 LT GREY IC (350ml)	C13T48RE00	SC-P8530D GRAY IC 700ML			
C13T44VA00	SC-P7530 ORANGE IC (350ml)					
C13T44VB00	SC-P7530 GREEN IC (350ml)					
C13T44VD00	SC-P7530 VIOLET IC (350ml)					
C13T892100	Black Ink Cartridge (700 ml)	SC-S4/6/80670	C13T892100	Black Ink Cartridge (700 ml)		
C13T892200	Cyan Ink Cartridge (700 ml)		C13T892200	Cyan Ink Cartridge (700 ml)		
C13T892300	Magenta Ink Cartridge (700 ml)		C13T892300	Magenta Ink Cartridge (700 ml)		
C13T892400	Yellow Ink Cartridge (700 ml)	SC-S80670	C13T892400	Yellow Ink Cartridge (700 ml)		
C13T892500	SC-S80670 LIGHT CYAN IC (700ML)		C13T892500	SC-S80670 LIGHT CYAN IC (700ML)		
C13T892600	SC-S80670 LIGHT MAGENTA IC (700ML)		C13T892600	SC-S80670 LIGHT MAGENTA IC (700ML)		
C13T892700	SC-S80670 LIGHT BLACK IC (700ML)		C13T892700	SC-S80670 LIGHT BLACK IC (700ML)		
C13T892800	SC-S80670 ORANGE IC (700ML)		C13T892800	SC-S80670 ORANGE IC (700ML)		
C13T892900	SC-S80670 RED IC (700ML)		C13T892900	SC-S80670 RED IC (700ML)		
C13T892A00	SC-S80670 WHITE IC (600ML)	SC-R5030	C13T892A00	SC-S80670 WHITE IC (600ML)		
C13T45R100	SC-R5030 Black 3000ml (1.5L X2)		C13T45R100	SC-R5030 Black 3000ml (1.5L X2)		
C13T45R200	SC-R5030 Cyan 3000ml (1.5L X2)		C13T45R200	SC-R5030 Cyan 3000ml (1.5L X2)		
C13T45R300	SC-R5030 Magenta 3000ml (1.5L X2)		C13T45R300	SC-R5030 Magenta 3000ml (1.5L X2)		
C13T45R400	SC-R5030 Yellow 3000ml (1.5L X2)		C13T45R400	SC-R5030 Yellow 3000ml (1.5L X2)		
C13T45R500	SC-R5030 Light Cyan 3000ml (1.5L X2)		C13T45R500	SC-R5030 Light Cyan 3000ml (1.5L X2)		
C13T45R600	SC-R5030 Light Magenta 3000ml (1.5L X2)		C13T45R600	SC-R5030 Light Magenta 3000ml (1.5L X2)		
C13T45R700	SC-R5030 Optimizer 3000ml (1.5L X2)		C13T45R700	SC-R5030 Optimizer 3000ml (1.5L X2)		
C13T45R800	SC-R5030 Maintenance Liquid 3L (1.5L X2)		C13T45R800	SC-R5030 Maintenance Liquid 3L (1.5L X2)		
C13T43Y100	Epson UltraChrome D6r-S 200ml Black Ink Cartridge		SL-D830	C13T43Y100	Epson UltraChrome D6r-S 200ml Black Ink Cartridge	
C13T43Y200	Epson UltraChrome D6r-S 200ml Cyan Ink Cartridge	C13T43Y200		Epson UltraChrome D6r-S 200ml Cyan Ink Cartridge		
C13T43Y300	Epson UltraChrome D6r-S 200ml Magenta Ink Cartridge	C13T43Y300		Epson UltraChrome D6r-S 200ml Magenta Ink Cartridge		
C13T43Y400	Epson UltraChrome D6r-S 200ml Yellow Ink Cartridge	SL-D3000	C13T43Y400	Epson UltraChrome D6r-S 200ml Yellow Ink Cartridge		
C13T43Y500	Epson UltraChrome D6r-S 200ml Light Cyan Ink Cartridge		C13T43Y500	Epson UltraChrome D6r-S 200ml Light Cyan Ink Cartridge		
C13T43Y600	Epson UltraChrome D6r-S 200ml Light Magenta Ink Cartridge		C13T43Y600	Epson UltraChrome D6r-S 200ml Light Magenta Ink Cartridge		
C13T710100	Epson UltraChrome D6 700ml Black Dye Ink Cartridge		C13T710100	Epson UltraChrome D6 700ml Black Dye Ink Cartridge		
C13T710200	Epson UltraChrome D6 700ml Cyan Dye Ink Cartridge		C13T710200	Epson UltraChrome D6 700ml Cyan Dye Ink Cartridge		
C13T710300	Epson UltraChrome D6 700ml Magenta Dye Ink Cartridge	SL-D3000	C13T710300	Epson UltraChrome D6 700ml Magenta Dye Ink Cartridge		
C13T710400	Epson UltraChrome D6 700ml Yellow Dye Ink Cartridge		C13T710400	Epson UltraChrome D6 700ml Yellow Dye Ink Cartridge		
C13T710500	Epson UltraChrome D6 700ml Light Cyan Dye Ink Cartridge		C13T710500	Epson UltraChrome D6 700ml Light Cyan Dye Ink Cartridge		
C13T710600	Epson UltraChrome D6 700ml Light Magenta Dye Ink Cartridge		C13T710600	Epson UltraChrome D6 700ml Light Magenta Dye Ink Cartridge		

# LASER PRINTER



# LASER PRINTER

## MENGAPA MEMILIH EPSON LASER PRINTER ?

Epson Laser printer di desain untuk memenuhi kebutuhan pertumbuhan bisnis Anda. Mulai dari biaya operasional yang sangat rendah, proses pencetakan yang cepat dan dilengkapi dengan berbagai fitur untuk mendukung volume produktifitas pencetakan yang optimal.

### Kualitas Cetak Luar Biasa

Seperti bahan bakar dengan performa tinggi di dalam sebuah mesin, toner asli Epson diformulasikan khusus untuk memberikan output berkualitas tinggi dan dapat diandalkan.

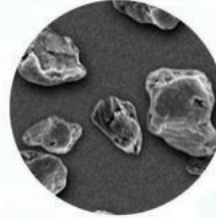

Conventional Toner

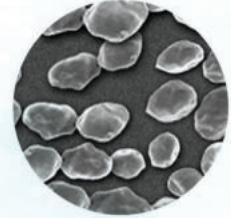

Epson's Genuine Toner

### Kualitas Warna Luar Biasa

Dengan ukuran partikel yang sama dan sangat stabil sifat elektrostatis, toner ini menghasilkan bahkan dan cakupan yang stabil sehingga semua cetakan Anda jelas dan dipenuhi dengan warna-warna yang kaya dan hidup

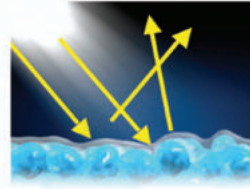

Conventional Toner

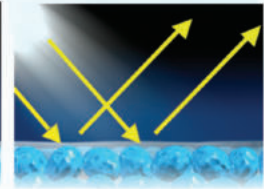

Epson's Genuine Toner

### Kejelasan hingga Detail Terbaik

Ukuran partikel Epson yang kecil dan seragam toner asli menghasilkan sangat halus dan hasil akurat untuk mengeluarkan detail sarang sekalipun.



# LASER PRINTER

Increase Workgroup's Productivity at Lower Running Cost

LASER PRINTER



## ACULASER C9500DN

Printing Technology	A3 Colour Laser Printer
Max Resolution	1,200 x 1,200 dpi
Print Speed	Up to 35 ppm (Simplex) / Up to 25 ppm (Duplex)
Paper Type	Plain Paper / Letterhead / Recycled / Colour / Preprinted / Semi-thick / Thick Paper1 / Thick Paper2 / Labels / Coated / Envelope / Special
Memory Interface	3GB USB 3.0, Network: Ethernet (1000Base-T/100Base-TX/10Base-T)
Connect	Epson iPrint, Epson Email Print, Remote Print Driver
Power Consumption	439W (Black) / 526W (Colour) Operating/ 65W Standby/43W Pre Heat/ 0.71W Sleep
Dimensions & Weight	512 x 518 x 109 mm, 5.1kg

## ACULASER M310DN



Max. Resolution	Up to 1,200 x 1,200 dpi
Print Speed	Up to 35 ppm 20,000 pages / month
Monthly Duty Cycle	Standard: Up to 350 sheets Maximum: Up to 850 sheets
Input Paper Capacity	250 sheets
Standard Output Tray Capacity	A4, A5, A6, B5, LT, HLT, LGL, GLT, GLG, EXE, F4, Label, Envelope (C5, C6, DL, Com10, Monarch, ISO-B5), Custom size: from 70 - 216 mm (width) to 148 - 356 mm (length)
Paper Size	Built-in USB 2.0, Ethernet Interface (10Base-Te / 100Base-TX / 1000Base-T)
Automatic Duplexing Interface	Windows XP / Vista / 7 / 8 / 8.1 / 10 Windows Server 2003 / 2008 / 2012 / 2016
OS Support	Mac OS X 10.6.8 or later Linux: Cups Ver 1.1.23, Ver 2.0.2 Citrix: XenApp7.6/XenDesktop7.6
Dimensions Weight	393 x 375 x 285 mm 14 kg



# LASER PRINTER

Increase Workgroup's Productivity at Lower Running Cost

## ACULASER M320DN



Max. Resolution	Up to 1200 x 1200 dpi
Print Speed	Up to 40 ppm
Monthly Duty Cycle	50,000 pages / month
Input Paper Capacity	Standard: Up to 350 sheets Maximum: Up to 850 sheets
Standard Output Tray Capacity	250 sheets
Paper Size	A4, A5, A6, B5, LT, HLT, LGL, GLT, GLG, EXE, F4, Label, Envelope (C5, C6, DL, Com10, Monarch, ISO-B5), Custom size: from 70 - 216 mm (width) to 148 - 356 mm (length)
Automatic Duplexing Interface	Built-in USB 2.0, Ethernet Interface (10Base-Te / 100Base-TX / 1000Base-T) Windows XP / Vista / 7 / 8 / 8.1 / 10 Windows Server 2003 / 2008 / 2012 / 2016
OS Support	Mac OS X 10.6.8 or later Linux: Cups Ver 1.1.23, Ver 2.0.2 Citrix: XenApp7.6/XenDesktop7.6
Dimensions	393 x 375 x 285 mm
Weight	14 kg

Compact and Reliable Mono Printer for Print & Cost Efficiency

## ACULASER M400DN



Max. Resolution	1,200 x 1,200 dpi
Print Speed	45 ppm
Monthly Duty Cycle	207,000 sheets
Input Paper Capacity	Standard: 700 sheets Maximum: 2,350 sheets
Standard Output Tray Capacity	250 sheets
Paper Size	A4, A5, A6, B5, LT, HLT, LGL, GLT, GLG, EXE, F4, Label, Envelope (C5, C6, DL, Com10, Monarch, ISO-B5), Custom size: from 70 - 216mm (width) to 148 - 356mm (length)
Automatic Duplexing Interface	Built-in Ethernet (100Base-TX/10Base-T) interface, High-speed USB 2.0 interface
OS Support	Windows® 2000, XP (32bit/64bit) / Vista (32bit/64bit) / Server 2003 (32bit/64bit) / Server 2008 (32bit/64bit), Mac OS 10.4.11 / Mac OS 10.5.8
Dimensions	393 x 426 x 324mm
Weight	14 kg

# LASER PRINTER

## Monochrome that Suits Diversity & Versatility

### ACULASER M8100DN



- Max. Resolution 1,200 x 1,200 dpi
- Print Speed Up to 40 ppm
- Monthly Duty Cycle Up to 220,000 pages per month
- Input Paper Capacity Standard: 600 sheets  
Maximum: 2,600 sheets  
Up to 500 sheets / Up to 750 sheets with Face-Up Tray
- Standard Output Tray Capacity Paper Size A3, A4, A5, A6, B4, B5, LT, HLT, GLT, GLG, EXE, F4, B. Envelopes: Monarch, DL, C6, C5, B5 Custom size : 70 x 148 mm - 297 x 450 mm
- Automatic Duplexing Interface Standard  
Hi-Speed USB 2.0, Ethernet (10Base-T/100BASE-TX/1000BASE-T)
- OS Support Windows XP, Vista, 7, 8, 8.1. Windows Server 2003, Server 2008, Server 2008R2, Server 2012, Server 2012R2, Mac OS X 10.6.8 or later, Linux Cups ver 1.1.23, ver 1.2.4
- Dimensions 490 x 410 x 320 mm
- Weight 21 kg

## Laser Printer Consumable

Order Code	Descriptions	Yield Character	Product
<b>TONER EPSON ACULASER MONO</b>			
C13S050439	High Cap Toner	2,200	M2010
C13S050440	Standard Cap Toner	1,000	
C13S051170	Imaging Cartridge	20,000	
C13S053038	Fuser Unit (220-240V)	200,000	
C13S051170	Imaging Cartridge	20,000	M4000N
C13S053038	Fuser Unit (220-240V)	200,000	
C13S050520	Dev Cart	1,500	M1200
C13S050521	Dev Cart	3,000	
C13S050586	High Capacity Toner Cartridge (Bk)	8,000	M2410DN
C13S050587	Standard Capacity Toner Cartridge (Bk)	3,000	
C13S050650	High Cap Toner	2,200	M1400
C13S050652	Standard Cap Toner	1,000	
C13S051221	Imaging Cartridge	15,000	M7000N
C13S050709	Toner Cartridge	2,500	M200DN
C13S050710	Toner Cartridge (Double Pack)	2 x 2,500	
C13S050697	High Capacity Toner Cartridge	23,700	M400DN
C13S050698	Standard Capacity Toner Cartridge	12,000	
C13S051230	Photoconductor Unit	100,000	
C13S053057	Maintenance Unit	200,000	
C13S050689	High Capacity Toner Cartridge	10,000	M300D/ M300DN
C13S050690	Standard Capacity Toner Cartridge	2,700	

Order Code	Descriptions	Yield Character	Product
<b>TONER EPSON ACULASER COLOR</b>			
C13S050245	Black Toner Cartridge	10,000	C4200DN
C13S050242	Yellow Toner Cartridge	8,500	
C13S050243	Magenta Toner Cartridge	8,500	
C13S050244	Cyan Toner Cartridge	8,500	
C13S051109	Photoconductor Unit	35,000	
C13S053021	Fuser Unit	100,000	
C13S053022	Transfer Unit	35,000	
C13S051127	High Cap Toner Cartridge Black	9,500	C3800
C13S051126	High Cap Toner Cartridge Cyan	9,000	
C13S051125	High Cap Toner Cartridge Magenta	9,000	
C13S051124	High Cap Toner Cartridge Yellow	9,000	
C13S051130	Standard Cap Toner Cartridge Cyan	5,000	
C13S051129	Standard Cap Toner Cartridge Magenta	5,000	
C13S051128	Standard Cap Toner Cartridge Yellow	5,000	
C13S053024	Transfer Unit	100,000	C3800 / C2800
C13S053025	Fuser Unit	100,000	

Order Code	Descriptions	Yield Character	Product
<b>TONER EPSON ACULASER COLOR</b>			
C13S051158	Toner Cartridge High Cap Yellow	6,000	C2800
C13S051159	Toner Cartridge High Cap Magenta	6,000	
C13S051160	Toner Cartridge High Cap Cyan	6,000	
C13S051161	Toner Cartridge High Cap Black	8,000	
C13S050474	Toner Cartridge (Yellow)	14,000	C9200N
C13S050475	Toner Cartridge (Magenta)	14,000	
C13S050476	Toner Cartridge (Cyan)	14,000	
C13S050477	Toner Cartridge (Black)	17,000	
C13S050478	Waste Toner Collector	18,000	
C13S051175	Photoconductor Unit (Yellow)	30,000	
C13S051176	Photoconductor Unit (Magenta)	30,000	
C13S051177	Photoconductor Unit (Cyan)	30,000	
C13S051178	Photoconductor Unit (Black)	30,000	
C13S050590	Toner Cartridge (Yellow)	6,000	C3900DN
C13S050591	Toner Cartridge (Magenta)	6,000	
C13S050592	Toner Cartridge (Cyan)	6,000	
C13S050593	Toner Cartridge (Black)	6,000	
C13S050595	Waste Toner Bottle	100,000	
C13S051201	Photoconductor Unit (Yellow)	30,000	
C13S051202	Photoconductor Unit (Magenta)	30,000	
C13S051203	Photoconductor Unit (Cyan)	30,000	
C13S051204	Photoconductor Unit (Black)	30,000	
C13S051201	Fuser Unit	100,000	
C13S050611	High Cap Toner Cartridge Yellow	1,400	C1700
C13S050612	High Cap Toner Cartridge Magenta	1,400	
C13S050613	High Cap Toner Cartridge Cyan	1,400	
C13S050614	High Cap Toner Cartridge Black	2,000	
C13S050627	Standard Cap Toner (Yellow)	2,500	C2900N
C13S050628	Standard Cap Toner (Magenta)	2,500	
C13S050629	Standard Cap Toner (Cyan)	2,500	
C13S050630	Standard Cap Toner (Black)	3,000	
C13S050631	Double Cap Toner (Black)	2 x 3,000	
C13S051211	Drum Cartridge	36,000	
C13S053043	Fuser Unit (220-240V)	50,000	
C13S050602	Toner Cartridge (Yellow)	7,500	
C13S050603	Toner Cartridge (Magenta)	7,500	
C13S050604	Toner Cartridge (Cyan)	7,500	
C13S050605	Toner Cartridge (Black)	6,500	
C13S050606	Toner Cartridge Yellow (DP)	15,000	C9300N
C13S050607	Toner Cartridge Magenta (DP)	15,000	
C13S050608	Toner Cartridge Cyan (DP)	15,000	
C13S050609	Toner Cartridge Black (DP)	13,000	
C13S050610	Waste Toner Collector	24,000	
C13S051209	Photoconductor Unit (Color)	24,000	
C13S051210	Photoconductor Unit (Black)	24,000	

# LASER PRINTER

## Laser Printer Consumable

Order Code	Descriptions	Yield Character	Product	Order Code	Descriptions	Yield Character	Product
<b>TONER EPSON ACULASER MONO</b>				<b>TONER EPSON ACULASER MONO</b>			
C13S050659	High Cap Toner Cartridge Black	13,700	C500DN	C13S050097	Yellow Developer Cartridge for AcuLaser	4,500	C1900/ C900
C13S050656	High Cap Toner Cartridge Yellow	13,700		C13S050098	Magenta Developer Cartridge for AcuLaser	11,250/ 45,000	
C13S050657	High Cap Toner Cartridge Magenta	13,700		C13S050099	Cyan Developer Cartridge for AcuLaser	52,500/ 210,000	
C13S050658	High Cap Toner Cartridge Cyan	13,700		C13S051083	PhotoConductor Unit for AcuLaser	6,250/ 25,000	
C13S050663	Standard Cap Toner Cartridge Black	10,500		C13S053009	Transfer Unit for AcuLaser	1,500	
C13S050660	Standard Cap Toner Cartridge Yellow	7,500		C13S050101	Waste Toner Collector for AcuLaser	1,500	
C13S050661	Standard Cap Toner Cartridge Magenta	7,500		C13S050155	Yellow Developer Cartridge for AcuLaser	1,500	
C13S050662	Standard Cap Toner Cartridge Cyan	7,500		C13S050156	Magenta Developer Cartridge for AcuLaser	1,500	
C13S051227	Photoconductor Unit Black	50,000		C13S050157	Cyan Developer Cartridge for AcuLaser	8,500	
C13S051224	Photoconductor Unit Yellow	50,000		C13S050091	Toner Cartridge Black for AcuLaser	6,000	C4000
C13S051225	Photoconductor Unit Magenta	50,000		C13S050088	Toner Cartridge Yellow for AcuLaser	6,000	
C13S051226	Photoconductor Unit Cyan	50,000		C13S050089	Toner Cartridge Magenta for AcuLaser	6,000	
C13S050664	Waste Toner Collector	25,000		C13S050090	Toner Cartridge Cyan for AcuLaser	30,000	
C13S040002	Staple Cartridge	5,000		C13S051081	PhotoConductor Unit for AcuLaser	25,000	
C13S053048	Transfer Unit	150,000		C13S053006	Transfer Unit for AcuLaser	100,000	C4000/ C4100/ C3000N
C13S051020	Imaging Cartridge	4,500	EPL-3000	C13S053007	Fuser Unit 220 for AcuLaser	10,000	C4000
C13S050005	Developer Cartridge	3,000	EPL-5500	C13S050149	Toner Cartridge Black	8,000	AL-C4100
C13S051029	Photoconductor Unit	20,000		C13S050148	Toner Cartridge Yellow	8,000	
C13S050010	Toner Cartridge	6,000	EPL-5700/ 5700L/ 5800/ 5800L	C13S050147	Toner Cartridge Magenta	8,000	
C13S051055	Photoconductor Unit	20,000	EPL-5700/ 5700L/ 5800/ 5800L/ 6100/ 6100L	C13S050146	Toner Cartridge Cyan	30,000	EPL-C8000 /C8200
C13S050087	Developer Cartridge	6,000	EPL-5900/ 5900L/ 6100/ 6100L	C13S051093	Photoconductor Unit	30,000	
C13S050095	Developer Cartridge (3K)	3,000	EPL-6100/ 6100L	C13S053012	Fuser Unit 220	100,000	
C13S050167	Developer Cartridge	3,000	EPL-6200/ 6200L	C13S050078	Toner Cartridge Black	4,500	
C13S051099	Photoconductor Unit	20,000		C13S050075	Toner Cartridge Yellow	6,000	
C13S050166	Developer Cartridge	6,000	EPL-6200	C13S050076	Toner Cartridge Magenta	6,000	
C13S051056	Imaging Cartridge	8,500	EPL-N1600	C13S050077	Toner Cartridge Cyan	6,000	EPL-C8000/ C8200/ C8500/ C8600
C13S051069	Imaging Cartridge	7,600	EPL-N1610 /N2010	C13S051061	PhotoConductor Unit	6,000	
C13S051070	Imaging Cartridge	15,000	EPL-N2050 /N2050+	C13S052002	Fuser Oil Roll	20,000	
C13S051111	Imaging Cartridge	17,000	EPL-N3000	C13S050020	Waste Toner Collector	20,000	
C13S053017	Fuser Unit	200,000		C13S050079	Toner Cartridge for AcuLaser (Yellow)	6,000	
C13S051077	Imaging Cartridge	10,000	EPL-N2120	C13S050080	Toner Cartridge for AcuLaser (Magenta)	6,000	C8500
C13S051091	Imaging Cartridge	10,000	EPL-N2500	C13S050081	Toner Cartridge for AcuLaser (Cyan)	6,000	
C13S051035	Imaging Cartridge	10,000	EPL-N2000	C13S050082	Toner Cartridge for AcuLaser (Black)	5,500	C8600
C13S051060	Imaging Cartridge	23,000	EPL-N4000+	C13S051073	Photo Conductor for AcuLaser	12,500/ 50,000	AL-C3000N
C13S050033	Toner Cartridge for AcuLaser (Black)	6,000	C1000/ C2000	C13S051082	PhotoConductor for AcuLaser	12,500/ 50,000	
C13S050034	Toner Cartridge for AcuLaser (Yellow)	6,000		C13S050213	Toner Cartridge Black	4,500	
C13S050035	Toner Cartridge for AcuLaser (Magenta)	6,000		C13S050210	Toner Cartridge Yellow	3,500	AL-C9100
C13S050036	Toner Cartridge for AcuLaser (Cyan)	7,500/ 21,000		C13S050211	Toner Cartridge Magenta	3,500	
C13S052003	Fuser Oil Roll for AcuLaser	7,500/ 30,000		C13S050212	Toner Cartridge Cyan	3,500	
C13S050037	Waste Toner Collector for AcuLaser	7,500/ 30,000		C13S050198	Toner Cartridge Black	15,000	
C13S051072	PhotoConductor Kit for AcuLaser	30,000/ 130,000		C13S050197	Toner Cartridge Cyan	12,000	
C13S053001	Transfer Belt Unit AcuLaser	100,000		C13S050196	Toner Cartridge Magenta	12,000	AL-C1100/N
C13S053003	Fuser Kit (220V) AcuLaser	4,500		C13S050195	Toner Cartridge Yellow	12,000	
C13S050100	Black Developer Cartridge for AcuLaser	4,500	C1900/ C900	C13S051105	Photoconductor Unit	30,000	
				C13S050194	Waste Toner Collector	24,000	
				C13S050190	Toner Cartridge Black	4,000	
				C13S050189	Toner Cartridge Cyan	4,000	
				C13S050188	Toner Cartridge Magenta	4,000	
				C13S050187	Toner Cartridge Yellow	4,000	
				C13S050193	Toner Cartridge Cyan	1,500	
				C13S050192	Toner Cartridge Magenta	1,500	AL-C1100
				C13S050191	Toner Cartridge Yellow	1,500	
				C13S051104	Photoconductor Unit	14,000	
				C13S050287	Color Economy Pack	3 x 1,500	

# BUSINESS & PHOTO SCANNER

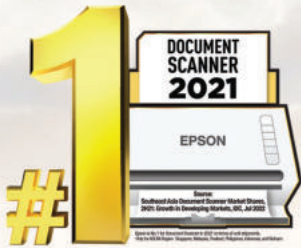

EPSON

Blue Works  
Jalan Raya No. 123  
Jakarta, Indonesia

Bill No: 001/2021  
Date: 05/16/2021  
Invoice No: 000001  
Total: 874.50

DESCRIPTION	QTY	PRICE	TOTAL
Blue Works	1	800.00	800.00
Blue Works	1	74.50	74.50
Blue Works	1	0.00	0.00
<b>TOTAL</b>			<b>874.50</b>

Blue Works  
Jalan Raya No. 123  
Jakarta, Indonesia

Blue Works  
Jalan Raya No. 123  
Jakarta, Indonesia

Blue Works  
Jalan Raya No. 123  
Jakarta, Indonesia



# BUSINESS & PHOTO SCANNER

## MENGAPA MEMILIH EPSON SCANNER ?

Dapatkan kecepatan dan kualitas terbaik dengan berbagai pilihan scanner terbaru dari Epson yang mampu menangkap semua detail untuk memenuhi kebutuhan bisnis Anda. Dengan fitur dan teknologi canggih milik Epson, Scanner ini memberi Anda lebih banyak daya, volume lebih tinggi, dan kecepatan lebih cepat untuk produktivitas lebih baik.

### CCD System

Pemindai memanfaatkan Charge-Coupled Device (CCD) scanning system, memantulkan dokumen yang diterangi dari serangkaian cermin melalui lensa ke sensor

kelebihan dari Teknologi CCD

- Kecepatan pemindaian lebih tinggi
- lebih jelas dan lebih detail untuk pemindaian film
- Kedalaman bidang yang lebih besar saat memindai dokumen atau objek 3D yang tidak rata pada kaca pemindai
- Kepadatan optik lebih tinggi



CIS Scanner

Text on "contactless" area is not clear



CCD Scanner

Text on "contactless" area is clear

### ReadyScan LED Technology

Dengan Teknologi ReadyScan LED, pemindaian dimulai secara instan tanpa memerlukan waktu pemanasan. Teknologi ini ramah lingkungan karena bebas merkuri, disipasi panas rendah dan membutuhkan konsumsi daya yang lebih rendah.



# BUSINESS & PHOTO SCANNER

## A4 Portable Sheet-Fed Scanner

### WORKFORCE ES-50/ES-60W

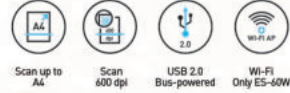

reddot award 2019  
winner

<b>Scanner Type</b>	A4 Sheet-fed colour scanner
<b>Sensor Type</b>	Contact Image Sensor (CIS)
<b>Light Source</b>	RGB LED
<b>Optical Resolution</b>	600 x 600 dpi
<b>Scan Area</b>	A4 (support F4)
<b>Document Size (Min)</b>	50.8 x 50.8 mm
<b>(Max)</b>	216 x 1,828.8 mm
<b>Supported Paper Weight</b>	35 - 270 g/m2
<b>ADF Capacity</b>	1 sheet
<b>Scanning Speed</b>	5.5 sec (ES-50), 4.0 sec (Battery) / 5.5 sec (USB Bus Powered) (ES-60W)
<b>Operating System</b>	Windows XP / Vista / 7 / 8 / 8.1 / 10 / Server 2003 / 2008 / 2012 / 2016 Mac OS X 10.6.8 or later
<b>Interface</b>	USB 2.0 (Micro-B), Wi-Fi (ES-60W)
<b>Dimensions</b>	272 x 47 x 33.8 mm
<b>Weight</b>	270g (ES-50), 300g (ES-60W)

### WORKFORCE DS-310

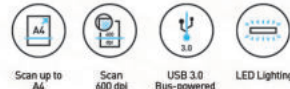

<b>Scanner Type</b>	A4 sheet-fed, one-pass duplex colour scanner
<b>Sensor Type</b>	Contact Image Scanner (CIS)
<b>Light Source</b>	RGB LED
<b>Optical Resolution</b>	600 x 600 dpi
<b>Scan Area</b>	A4 (support F4)
<b>Document Size (Min)</b>	50.8 x 70 mm
<b>(Max)</b>	216 x 1,117 mm
<b>Supported Paper Weight</b>	51.8-128 g/m2 (Postcard: 128-230 g/m2)
<b>ADF Capacity</b>	20 sheets (80 g/m2)
<b>Scanning Speed</b>	25 ppm/50 ipm (AC Adapter/Built-in Battery3), 5.0 ppm/10 ipm (USB 3.0 Bus Power)
<b>Operating System</b>	Windows XP/ Vista / 7 / 8 / 8.1 / 10 Mac OS X 10.5 .X or later
<b>Interface</b>	USB 3.0
<b>Dimensions</b>	288 x 88.5 x 51 mm
<b>Weight</b>	1,1 kg

# BUSINESS & PHOTO SCANNER

## WORKFORCE DS-360W



- Scanner Type** A4 sheet-fed, one-pass duplex scanner
- Sensor Type** Contact Image Scanner (CIS)
- Light Source** RGB LED
- Optical Resolution** 600 x 600 dpi
- Scan Area** A4 (support F4)
- Document Size (Min)** 50.8 x 70 mm
- (Max)** 216 x 1,117 mm
- Supported Paper Weight** 51.8-128 g/m2 (Postcard: 128-230 g/m2)
- ADF Capacity** 20 sheets (80 g/m2)
- Scanning Speed** 25 ppm/50 ipm (AC Adapter/Built-in Battery3), 5.0 ppm/10 ipm (USB 3.0 Bus Power)
- Operating System** Windows XP/ Vista / 7 / 8 / 8.1 / 10  
Mac OS X 10.6.8 or later
- Interface** USB 3.0, Wi-Fi, Wi-Fi Direct
- Dimensions** 288 x 88.5 x 67 mm
- Weight** 1,3 kg

## Sheet-Fed

## WORKFORCE DS-410

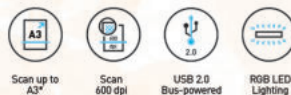

- Scanner Type** A4 Sheet-fed, one-pass duplex colour scanner
- Sensor Type** Contact Image Sensor (CIS) x 2
- Light Source** RGB LED
- Optical Resolution** 600 x 600 dpi
- Scan Area** A4 (support F4)
- Document Size (Min)** 50.8 x 50.8 mm
- (Max)** 215.9 x 3,048 mm
- Supported Paper Weight** 50 - 209 g/m2 (A8 or less : 127 - 209 g/m2)
- ADF Capacity** 50 sheets (80g/m2)
- Scanning Speed** 26 ppm / 52 ipm (Monochrome, Colour)
- Operating System** Windows XP / Vista / 7 / 8 / 8.1 / 10 / Server  
2003 / 2008 / 2012 / 2016, Mac OS X 10.6.8 or later
- Interface** USB2.0
- Dimensions** 297 x 152 x 154 mm
- Weight** 2,5kg

# BUSINESS & PHOTO SCANNER

## A4 Sheet-Fed Scanners



### WORKFORCE DS-530II



Scan up to A3\*

Scan from 27gsm to 413gsm

One Pass Duplex Scanning

<b>Scanner Type</b>	A4 Sheet-fed, one-pass duplex colour scanner
<b>Sensor Type</b>	Contact Image Scanner (CIS)
<b>Light Source</b>	RGB LED
<b>Optical Resolution</b>	600 x 600 dpi
<b>Document Size (Min)</b>	50.8 x 50.8 mm
<b>(Max)</b>	215.9 x 6096 mm
<b>Supported Paper Weight</b>	27 - 413 g/m <sup>2</sup> (A8 or less 127 - 413 g/m <sup>2</sup> )
<b>ADF Capacity</b>	50 sheets (80g/m <sup>2</sup> )
<b>Scanning Speed</b>	Resolution (Colour/Greyscale/Mono) Simplex / Duplex 200 dpi 35 ppm / 70 ipm 300 dpi 35 ppm / 70 ipm 600 dpi 8 ppm / 16 ipm
<b>Operating System</b>	Windows XP / Vista / 7 / 8 / 8.1 / 10 / Server 2003 / Server 2008 / Server 2012 / Server 2016 USB 3.2 Gen 1
<b>Interface</b>	
<b>Dimensions</b>	296 x 169 x 176 mm
<b>Weight</b>	3.7 kg



### WORKFORCE DS-570WII



Scan up to A4

Scan from 27gsm to 413gsm

One Pass Duplex Scanning

Wi-Fi\*\*

Epson Smart Panel\*\*

<b>Scanner Type</b>	A4 Sheet-fed, one-pass duplex colour scanner
<b>Sensor Type</b>	Contact Image Scanner (CIS)
<b>Light Source</b>	RGB LED
<b>Optical Resolution</b>	600 x 600 dpi
<b>Document Size (Min)</b>	50.8 x 50.8 mm
<b>(Max)</b>	215.9 x 6096 mm
<b>Supported Paper Weight</b>	27 - 413 g/m <sup>2</sup> (A8 or less : 127 - 413 g/m <sup>2</sup> )
<b>ADF Capacity</b>	50 sheets (80g/m <sup>2</sup> )
<b>Scanning Speed</b>	Resolution (Colour/Greyscale/Mono) Simplex / Duplex 200 dpi 35 ppm / 70 ipm 300 dpi 35 ppm / 70 ipm 600 dpi 8 ppm / 16 ipm
<b>Operating System</b>	Windows XP / Vista / 7 / 8 / 8.1 / 10 / Server 2003 / Server 2008 / Server 2012 / Server 2016 USB 3.2 Gen 1, Wi-Fi (802.11 b/g/n)
<b>Interface</b>	
<b>Dimensions</b>	296 x 169 x 176 mm
<b>Weight</b>	3.7 kg



# BUSINESS & PHOTO SCANNER



## WORKFORCE ES-580W



<b>Scanner Type</b>	A4 Sheet-fed, one pass duplex colour scanner
<b>Sensor Type</b>	Colour Contact Image Sensor (CIS)
<b>Light Source</b>	RGB LED
<b>Optical Resolution</b>	600 x 600 dpi
<b>Document Size (Min)</b>	50.8 x 50.8 mm
<b>(Max)</b>	215.9 x 6096 mm
<b>Supported Paper Weight</b>	27 - 413 g/m <sup>2</sup>
<b>ADF Capacity</b>	100 sheets (80 g/m <sup>2</sup> )
<b>Scanning Speed</b>	Resolution (A4, Colour/Monochrome) 300 dpi 35 ppm / 70 ipm 600 dpi 12 ppm / 24 ipm
<b>Operating System</b>	Windows 7 / 8 / 8.1 / 10 / Server 2003 / Server 2008 / Server 2012 / Server 2016 / Server 2019
<b>Interface</b>	USB 3.2 Gen 1, Wi-Fi (802.11 b/g/n), Wi-Fi Direct (max 8 connections)
<b>Dimensions</b>	296 x 169 x 167 mm
<b>Weight</b>	3.7kg



## WORKFORCE DS-730N



<b>Scanner Type</b>	Sheet-fed, one pass duplex colour scanner
<b>Sensor Type</b>	Colour Contact Image Sensor (CIS)
<b>Light Source</b>	RGB LED
<b>Optical Resolution</b>	600 x 600 dpi
<b>Document Size (Min)</b>	50.8 x 50.8 mm
<b>(Max)</b>	215.9 x 6096 mm
<b>Supported Paper Weight</b>	27 - 413 g/m <sup>2</sup>
<b>ADF Capacity</b>	100 sheets (80 g/m <sup>2</sup> )
<b>Scanning Speed</b>	Resolution (A4, Colour/Monochrome) 300 dpi 40 ppm / 80 ipm 600 dpi 12 ppm / 24 ipm
<b>Operating System</b>	Windows XP SP3 / Vista / 7 / 8 / 8.1 / 10 / Server 2003 / Server 2008 / Server 2012 / Server 2016 / Server 2019
<b>Interface</b>	USB2.0 and Ethernet (1000BASE-T/100BASE-TX/10BASE-T)
<b>Dimensions</b>	296 x 169 x 167 mm
<b>Weight</b>	3.6kg

# BUSINESS & PHOTO SCANNER

## A4 Sheet-Fed Scanners



### WORKFORCE DS-770II



<b>Scanner Type</b>	A4 Sheet-fed, one pass duplex colour scanner
<b>Sensor Type</b>	Contact Image Sensor (CIS)
<b>Light Source</b>	RGB LED
<b>Optical Resolution</b>	600 x 600 dpi
<b>Document Size (Min)</b>	50.8 x 50.8 mm
<b>(Max)</b>	215.9 x 6096 mm
<b>Supported Paper Weight</b>	27 - 413 g/m <sup>2</sup> (A8 or less 127 - 413 g/m <sup>2</sup> )
<b>ADF Capacity</b>	100 sheets (80g/m <sup>2</sup> )
<b>Scanning Speed</b>	Resolution (Colour/Greyscale/Mono) Simplex / Duplex 200 dpi 45 ppm / 90 ipm 300 dpi 45 ppm / 90 ipm 600 dpi 12 ppm / 24 ipm
<b>Operating System</b>	Windows XP / Vista / 7 / 8 / 8.1 / 10 / Server 2003 / Server 2008 / Server 2012 / Server 2016
<b>Interface</b>	USB 3.2 Gen 1
<b>Dimensions</b>	296 x 169 x 176 mm
<b>Weight</b>	3.7 kg

### WORKFORCE DS-790WN



<b>Scanner Type</b>	A4 sheet-fed, one-pass duplex colour scanner
<b>Sensor Type</b>	Colour Contact Image Sensor (CIS) x 2
<b>Light Source</b>	RGB LED x 2
<b>Optical Resolution</b>	600 x 600 dpi
<b>Document Size (Min)</b>	50.8 x 50.8 mm
<b>(Max)</b>	215.9 x 6096 mm
<b>Supported Paper Weight</b>	27 - 413 g/m <sup>2</sup> (A8 or less 127 - 413 g/m <sup>2</sup> )
<b>ADF Capacity</b>	100 sheets (80 g/m <sup>2</sup> )
<b>Scanning Speed</b>	Resolution (Colour/Greyscale/Mono) Simplex / Duplex 200 dpi 45 ppm / 90 ipm 300 dpi 45 ppm / 90 ipm 600 dpi 12 ppm / 24 ipm
<b>Operating System</b>	Windows XP / Vista / 7 / 8 / 8.1 / 10 / 11, Server 2003 / 2008 / 2012 / 2019 / 2022 Mac OS X 10.6.8 or later
<b>Interface</b>	USB 3.2 Gen 1, Ethernet (1000BASE-T/100BASE-TX/10BASE-T), Wi-Fi (IEEE 802.11 b/g/n), Wi-Fi Direct (max 8 connections), USB 2.0 Host
<b>Dimensions</b>	296 x 169 x 167 mm
<b>Weight</b>	3,7kg

# BUSINESS & PHOTO SCANNER



## WORKFORCE DS-870



Scan up to A3+



Scan 600 dpi



USB 3.0 Bus-powered



RGB LED Lighting

### Scanner Type

A4 Sheet-fed, one pass duplex colour scanner

### Sensor Type

Contact Image Sensor (CIS)

### Light Source

RGB LED

### Optical Resolution

600 x 600 dpi

### Document Size (Min)

50.8 x 50.8 mm

### (Max)

215.9 x 609.6 mm

### Supported Paper Weight

27 - 413 g/m<sup>2</sup> (A8 or less 127 - 413 g/m<sup>2</sup>)

### ADF Capacity

100 sheets (80 g/m<sup>2</sup>)

### Scanning Speed

Resolution (Colour/Greyscale/Mono)

Simplex / Duplex

200 dpi 65 ppm / 130 ipm

300 dpi 65 ppm / 130 ipm

600 dpi 16 ppm / 32 ipm

### Operating System

Windows XP / Vista / 7 / 8 / 8.1 / 10

Mac OS X 10.5.X or later

### Interface

USB 3.0, Optional Ethernet (With Network Interface Unit)

### Dimensions

296 x 169 x 167 mm

### Weight

3,6kg



## WORKFORCE DS-970



Scan up to A3+



Scan 600 dpi



USB 3.0 Bus-powered



RGB LED Lighting

### Scanner Type

A4 Sheet-fed, one pass duplex colour scanner

### Sensor Type

Contact Image Sensor (CIS)

### Light Source

RGB LED

### Optical Resolution

600 x 600 dpi

### Scan Area

A4 (support F4)

### Document Size (Min)

50.8 x 50.8 mm

### (Max)

215.9 x 609.6 mm

### Supported Paper Weight

27 - 413 g/m<sup>2</sup> (A8 or less 127 - 413 g/m<sup>2</sup>)

### ADF Capacity

20 sheets (80 g/m<sup>2</sup>)

### Scanning Speed

Resolution (Colour/Greyscale/Mono)

Simplex / Duplex

200 dpi 65 ppm / 130 ipm

300 dpi 65 ppm / 130 ipm

600 dpi 16 ppm / 32 ipm

### Operating System

Windows XP / Vista / 7 / 8 / 8.1 / 10

Mac OS X 10.5.X or later

### Interface

USB 3.0, Optional Ethernet (With Network Interface Unit)

### Dimensions

296 x 169 x 167 mm

### Weight

3,6kg

# BUSINESS & PHOTO SCANNER

## A3 Sheet-Fed Scanners

### WORKFORCE DS-30000



Scan up to  
A3

Scan  
600 dpi

USB 3.0  
Bus-powered

White LED  
Lighting



**Scanner Type**  
**Sensor Type**  
**Light Source**  
**Optical Resolution**  
**Document Size (Min)**  
**(Max)**  
**Supported Paper Weight**  
**ADF Capacity**  
**Scanning Speed**

**Operating System**

**Interface**  
**Dimensions**  
**Weight**

A3 sheet-fed, one-pass duplex colour scanner  
Colour Contact Image Sensor (CIS)  
White LED  
600 x 600 dpi  
50.8 x 69 mm  
304.8 x 5.588 mm  
27-413 g/m<sup>2</sup>  
A4 : 120 sheets, A3 : 60 sheets (80 g/m<sup>2</sup>)  
Resolution [A4 Colour/Monochrome]  
200 dpi 70 ppm / 140 ipm  
300 dpi 70 ppm / 140 ipm  
600 dpi 22 ppm / 44 ipm  
Windows Server 2003 / 2008 / 2012 / 2016 /  
2019, Mac OS X 10.6.8 or later  
Windows XP SP3 / Vista / 7 / 8 / 8.1 / 10  
USB 3.0  
371 x 208 x 219 mm  
5.8 kg

### WORKFORCE DS-32000



Scan up to  
A3

Scan  
600 dpi

USB 3.0  
Bus-powered

White LED  
Lighting



**Scanner Type**  
**Sensor Type**  
**Light Source**  
**Optical Resolution**  
**Document Size (Min)**  
**(Max)**  
**Supported Paper Weight**  
**ADF Capacity**

**Scanning Speed**

**Operating System**

**Interface**  
**Dimensions**  
**Weight**

A3 sheet-fed, one-pass duplex colour scanner  
Colour Contact Image Sensor (CIS)  
White LED  
600 x 600 dpi  
50.8 x 69 mm  
304.8 x 5.588 mm  
20 - 413 (80 g/m<sup>2</sup>)  
A4 120 sheets, A3 : 60 sheets  
Delicate Feed Mode : 20 sheets (A4),  
10 sheets (A3)  
Resolution [A4 Colour/Monochrome]  
200 dpi 90 ppm / 180 ipm  
300 dpi 90 ppm / 180 ipm  
600 dpi 26 ppm / 52 ipm  
Windows Server 2003 / 2008 / 2012 / 2016 /  
2019, Mac OS X 10.6.8 or later  
Windows XP SP3 / Vista / 7 / 8 / 8.1 / 10  
USB 3.0  
371 x 167 x 245mm  
6.9 kg

# BUSINESS & PHOTO SCANNER

## A4 Flatbed Business Scanner

### WORKFORCE DS-1630



Scan up to  
A4



Scan  
1200 dpi



RGB LED  
Lighting



USB 2.0  
Bus-powered



<b>Scanner Type</b>	ADF + Flatbed colour image scanner
<b>Sensor Type</b>	Colour Contact Image Sensor (CIS)
<b>Light Source</b>	RGB LED
<b>Optical Resolution</b>	1200 dpi x 1200 dpi
<b>Document Size (Min)</b>	89 x 127 mm (ADF Simplex), 89 x 170 mm (ADF Duplex)
<b>(Max)</b>	216 x 297 mm (Flatbed), 215.9 x 3048 mm (ADF Simplex)
<b>Supported Paper Weight</b>	50 - 120 g/m <sup>2</sup>
<b>ADF Capacity</b>	50 sheets (80g/m <sup>2</sup> )
<b>Scanning Speed</b>	Flatbed (colour) 200-300 dpi approx. 7.0 sec, 1.4 msec/line 600 dpi approx. 26 sec, 3.2 msec/line ADF (colour) 200-300 dpi 25 ppm / 10 ipm 600 dpi 9.0 ppm / 6.0 ipm
<b>Operating System</b>	Microsoft Windows XP (Home / Professional / Professional x64) / Vista [32-bit / 64-bit] / 7 [32-bit/64-bit], Mac OS X 10.4.11 or later
<b>Interface</b>	USB 3.0
<b>Dimensions</b>	450x318x121mm
<b>Weight</b>	4.1kg

### WORKFORCE DS-6500



Scan up to  
A4



Scan  
1200 dpi



USB 3.0  
Bus-powered



White LED  
Lighting



<b>Scanner Type</b>	A4 Flatbed colour image scanner with duplex ADF
<b>Sensor Type</b>	4 Line Colour CCD
<b>Light Source</b>	White LED
<b>Optical Resolution</b>	1200 dpi x 1200 dpi
<b>Document Size (Min)</b>	100 mm x 148 mm
<b>(Max)</b>	215.9 mm x 1016 mm
<b>Supported Paper Weight</b>	50 - 128 g/m <sup>2</sup> (<A6 60 - 190 g/m <sup>2</sup> )
<b>ADF Capacity</b>	100 sheets (80 g/m <sup>2</sup> )
<b>Scanning Speed</b>	Flatbed (colour 24-bit) 300 dpi approx. 8.0 sec, 0.6 msec/line 600 dpi approx. 22 sec, 1.69 msec/line ADF (colour 24-bit) 200-300 dpi 25 ppm / 50 ipm 600 dpi 4 ppm / 8 ipm
<b>Operating System</b>	Microsoft Windows XP (Home / Professional / Professional x64) / Vista [32-bit/64-bit] / 7 [32-bit/64-bit], Mac OS X 10.4.11 or later
<b>Interface</b>	Hi-Speed USB 2.0, Ethernet (Optional)
<b>Dimensions</b>	217 x 495 x 360 mm
<b>Weight</b>	9.8 kg

# BUSINESS & PHOTO SCANNER

## A4 Flatbed Business Scanner

### WORKFORCE DS-7500



Scan up to A4



Scan 1200 dpi



USB 2.0 Bus-powered



White LED Lighting



#### Scanner Type

A4 Flatbed colour image scanner with duplex ADF

#### Sensor Type

4 Line Colour CCD

#### Light Source

White LED

#### Optical Resolution

1200 dpi x 1200 dpi

#### Document Size (Min)

100 mm x 148 mm

#### (Max)

215.9 mm x 1016 mm

#### Supported Paper Weight

50 - 128 g/m<sup>2</sup> (<A6 60 - 190 g/m<sup>2</sup>)

#### ADF Capacity

100 sheets (80 g/m<sup>2</sup>)

#### Scanning Speed

Flatbed (colour 24-bit)

300 dpi approx. 8.0 sec, 0.6 msec/line

600 dpi approx. 22 sec, 1.69 msec/line

ADF (colour 24-bit)

200-300 dpi 40 ppm / 80 ipm

600 dpi 8 ppm / 13 ipm

#### Operating System

Microsoft Windows XP (Home / Professional

/ Professional x64) / Vista (32-bit/64-bit) /

7 (32-bit/64-bit), Mac OS X 10.4.11 or later

Hi-Speed USB 2.0, Ethernet (Optional)

#### Interface

#### Dimensions

217 x 495 x 360 mm

#### Weight

9.8 kg

## A3 Flatbed Business Scanner

### WORKFORCE DS-50000



Scan up to A3



Scan 600 dpi



USB 2.0 Bus-powered



#### Scanner Type

A3 Flatbed colour image scanner

#### Sensor Type

4 Line Colour CCD

#### Light Source

White LED

#### Optical Resolution

600 dpi x 600 dpi

#### Document Size (Max)

A3 (11.7" x 17")

#### Scanning Speed

Flatbed (colour 24-bit)

300 dpi approx. 4.0 sec, 0.351 msec/line

600 dpi approx. 10 sec, 0.702 msec/line

#### Operating System

Microsoft® Windows XP (Home /

Professional / Professional x64) / Vista

(32-bit/64-bit) / 7 (32-bit/64-bit),

Mac OS X 10.4.11 or later

#### Interface

#### Dimensions

Hi-Speed USB 2.0, Ethernet (Optional)

640x468x156mm

#### Weight

14.8 kg

# BUSINESS & PHOTO SCANNER

## WORKFORCE DS-60000



Scan up to A3



Scan 600 dpi



USB 2.0 Bus-powered



White LED Lighting



**Scanner Type** A3 Flatbed colour image scanner with ADF  
**Sensor Type** 4 Line Colour CCD  
**Light Source** White LED  
**Optical Resolution** 600 dpi x 600 dpi  
**Document Size (Min)** 68 mm x 120 mm  
**(Max)** 297 mm x 2540 mm  
**Supported Paper Weight** 35 - 128 g/m<sup>2</sup> (<A6 60 - 190 g/m<sup>2</sup>)  
**ADF Capacity** 200 sheets (80 g/m<sup>2</sup>)  
**Scanning Speed** Flatbed (colour 24-bit)

### Operating System

300 dpi approx. 4.0 sec, 0.351 msec/line  
600 dpi approx. 10 sec, 0.702 msec/line  
ADF (colour 24-bit)  
200-300 dpi 40 ppm / 80 ipm  
600 dpi 7.5 ppm / 15 ipm  
**Operating System** Microsoft® Windows XP (Home / Professional / Professional x64) / Vista (32-bit/64-bit) / 7 (32-bit/64-bit), Mac OS X 10.4.11 or later  
**Interface** Hi-Speed USB 2.0, Ethernet (Optional)  
**Dimensions** 640x552x289mm  
**Weight** 26.9 kg

## WORKFORCE DS-70000



Scan up to A3



Scan 600 dpi



USB 2.0 Bus-powered



White LED Lighting



**Scanner Type** A3 Flatbed colour image scanner with ADF  
**Sensor Type** 4 Line Colour CCD  
**Light Source** White LED  
**Optical Resolution** 600 dpi x 600 dpi  
**Document Size (Min)** 68 mm x 120 mm  
**(Max)** 297 mm x 2540 mm  
**Supported Paper Weight** 35 - 128 g/m<sup>2</sup> (<A6 60 - 190 g/m<sup>2</sup>)  
**ADF Capacity** 200 sheets (80 g/m<sup>2</sup>)  
**Scanning Speed** Flatbed (colour 24-bit)

### Operating System

300 dpi approx. 4.0 sec, 0.351 msec/line  
600 dpi approx. 10 sec, 0.702 msec/line  
ADF (colour 24-bit)  
200-300 dpi 70 ppm / 140 ipm  
600 dpi 12 ppm / 24 ipm  
**Operating System** Microsoft® Windows XP (Home / Professional / Professional x64) / Vista (32-bit/64-bit) / 7 (32-bit/64-bit), Mac OS X 10.4.11 or later  
**Interface** Hi-Speed USB 2.0, Ethernet (Optional)  
**Dimensions** 289 x 640 x 552 mm  
**Weight** 26.9 kg

# BUSINESS & PHOTO SCANNER

## A4 Photo Scanners

### PERFECTION V3911



Scan up to  
A4



Scan  
4800 x 4800 dpi



RGB LED  
Lighting



USB 2.0  
Bus-powered



<b>Scanner Type</b>	A4 Flatbed Colour Image Scanner
<b>Light Source</b>	RGB LED
<b>Optical Resolution</b>	4,800 x 4,800 dpi
<b>Output Resolution</b>	50 – 4,800 dpi (in 1 dpi increments)
<b>Document Size</b>	216 x 297 mm
<b>Scanning Speed</b>	Reflective Scanning (Monochrome): 300 dpi; 10 sec Reflective Scanning (24 bit Colour): 300dpi; 10 sec
<b>Operating System</b>	Windows 7 / 8 / 8.1 / 10 / 11, Server 2003 / 2008 / 2012 / 2016 / 2019 Mac OS X 10.11 or later
<b>Interface</b>	USB 2.0
<b>Dimensions</b>	249 x 364 x 39 mm
<b>Weight</b>	1.4 kg

### PERFECTION V850



Scan up to  
A4



Scan  
6400 x 9600 dpi



White LED  
Lighting



USB 2.0  
Bus-powered



<b>Scanner Type</b>	Flatbed colour image scanner
<b>Light Source</b>	White LED
<b>Optical Resolution</b>	Main 6,400 dpi x Sub 9,600 dpi
<b>Output Resolution</b>	25 to 12,800 dpi (in 1 dpi increments)
<b>Document Size</b>	Reflective: Up to 216 x 297 mm Transparency: Up to 203 x 254 mm, 35mm x 18 frames strip film, 35mm x 12 frames mounted film, (6 x 20cm) x 1 frame Medium format, (4" x 5") x 1 frame, Up to 8" x 10" (with film area guide)
<b>Scanning Speed</b>	Reflective Scanning (Preview): 6 sec Reflective Scanning (Monochrome): 300 dpi; 12 sec Reflective Scanning (24 bit Colour): 300dpi; 12 sec
<b>Operating System</b>	Microsoft Windows XP / Vista / 7 / 8 / 8.1 / 10 Mac OS X 10.6.8 or later
<b>Interface</b>	USB 2.0
<b>Dimensions</b>	308 x 503 x 152.5 mm
<b>Weight</b>	6.6 kg



# BUSINESS & PHOTO SCANNER

## A3 Flatbed Business Scanner

### EXPRESSION 13000XL



<b>Scanner Type</b>	A3 Flatbed Colour Image Scanner
<b>Sensor Type</b>	6-line Colour CCD
<b>Light Source</b>	LED
<b>Optical Resolution</b>	2400 x 4800 dpi
<b>Output Resolution</b>	50 - 6400 dpi (1 dpi increments)
<b>Document Size (Max)</b>	310 x 437 mm (12.2 x 17.2") (Flatbed) 309 x 420 mm (12.2 x 16.5") (TPU)
<b>Film Capacity</b>	35 mm film x 48 Frames (Strip Film Holder) 35 mm film x 30 Frames (Mounted Film Holder)
<b>Scanning Speed</b>	A4 300 dpi Colour 12 sec, 300 dpi BW 12 sec
<b>Operating System</b>	Windows XP / Vista / 7 / 8 / 8.1 / 10 / Server 2003/2008/2012, Mac OS X 10.6.8 or later
<b>Interface</b>	USB 2.0
<b>Dimensions</b>	656 x 458 x 158 mm
<b>Weight</b>	14.3 kg

## Manage your Documents/Photos Effortlessly

### Epson ScanSmart\*

#### Photo

Large originals can be scanned and stitched into a single image with Epson ScanSmart. This software can also perform automatic enhancements to photos and save your files into a variety of formats.

\*Only applicable to V39 and V850



#### Document

Simplify your workflow with Epson ScanSmart. Review and edit your scans to rotate, delete, reorder or remove unnecessary pages. Save with automatic file and folder name by OCR detection for increased productivity.

\*Only applicable to ES-50 and ES-60W

### Epson DocumentScan App



Scan documents with your mobile devices and share it via email, through other apps or save it to selected cloud services such as Box, DropBox, Evernote®, Google® Drive™ and Microsoft® OneDrive®.

### Easy Photo Scan

Through a simple user interface, users can easily scan, view, edit, save and transfer scanned documents via Easy Photo Scan. 8 simple photo editing functions such as Rotation, Auto and Manual Enhance, Soft Focus and Red Eye Correction are also available for users to enhance and correct their photos as desired. The preview mode and thumbnail mode allow users to easily choose, edit and preview photos within the application.

Post-scan destinations, including local folder, Web Folder, email, Facebook, Picasa™, Evernote® and SugarSync®, are easily accessible through the software.

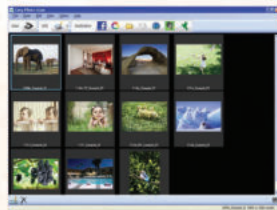

### Document Capture Pro\*\*



Document Capture Pro

Easily scan, view, edit, save and transfer scanned documents. The software recognises barcodes, characters and blank pages in scanned documents for batch separation. It allows you to create up to 30

customised job settings, with the option to assign shortcuts of the scan jobs to the scanner's operation panel to simplify scan workflow. With the built-in OCR capability, searchable PDF files can be created and documents can be saved into editable Microsoft Office formats. In addition, device and documents can be secured through password protection, by locating and tracking documents using the Advanced Log function.

\*\*Limited functionality for Mac version of Document Capture software.

### Document Capture Pro Server\*\*\*



Document Capture Pro Server

Document Capture Pro Server helps to centralise your scanning and manage your fleet of scanners without the need to install drivers on individual computers.

Document Capture Pro Server - Authentication Edition secures your scanner by limiting usage based on user list. Link the scanner to your directory services for automatic syncing of the user list and the Email server to enable Scan to Email, alerts, and reporting functions.

\*\*\*Only for Windows Server OS.

### InstantMark OMR Software

An affordable Optical Mark Recognition (OMR) solution that provides fast and accurate detection of data from optical answer sheets used for tests, assessments, surveys and other questionnaires. It allows users to create or use existing form templates for their projects too.

### Presto! Bizcard 5

A business card management solution that keeps a digital database of your business contacts. Information is extracted from the business cards by OCR.

# BUSINESS & PHOTO SCANNER

## Scanner Functions

### Photo

#### Photo Enhancement

Inject new life into faded films and photos. Restore original colours of faded photos to make them look as good as new with colour restoration.



Before Colour Restoration



After Colour Restoration

#### Built-in Transparency Unit with Film Holder

Selected Epson photo scanners feature a built-in transparency unit with film holder which allows users to conveniently digitise precious and fragile photo films and slides.



### Document

#### Text Enhancement

Improves text recognition when scanning text documents, whether in colour, greyscale or black-and-white. Removes background for better clarity, which is especially useful for double-sided printed documents.



Text Enhancement OFF



Text Enhancement ON

#### Document Skew Correction

Automatically adjusts and straightens scanned images.

#### Colour Enhancement & Colour Dropout

Remove or enhance the visibility of ink signatures such as "Confidential" and "Urgent" stamps. Users can pick one of the preset colours, all colours except black), or use the customised settings to dropout or enhance up to 5 colours of your choice with a single scan. Up to 10 preset colours can be saved for reuse.

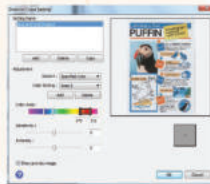

#### Automatic Feeding Mode

The Automatic Feeding Mode enables large volumes of documents to be scanned continuously. In addition, this mode allows you to scan documents one at a time without needing to arrange them by size and they will be saved into a single PDF.



#### Double Feed Detection Skip Function

Activate the Double Feed Detection Skip function to scan documents with stickers and labels.



#### Book Spine Correction

Scans are corrected for shadow and curvature around book spines for better readability and clarity of texts and images.



#### Paper Protection Function

Upon detection of abnormal paper feeding or stapled/folded paper, the paper feed will be stopped immediately, which prevents damage to your important documents.



#### Epson OCR Feature

This OCR add-on allows users to create searchable PDF files and automatically straighten and orientate documents based on character recognition.

#### PDF Security

Advanced PDF Security features are bundled with document scanners to prevent confidential documents from being accessed, edited or printed by unauthorised users. Passwords can be used to secure the PDF files.

#### Auto Area Segmentation (AAS)

This feature is useful when user is performing a black-&-white scan on documents with pictures and graphs. AAS segments a scanned document which has both text and image into 'Text Area' and 'Image Area'. The 'Text Area' is scanned in black-&-white and 'Image Area' is scanned in halftone.

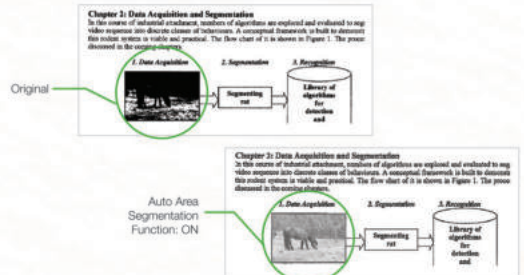

# EPSON

# SPEED UP YOUR BUSINESS WITH RELIABILITY YOU CAN TRUST.

Epson's latest scanner range delivers the speed and reliability for every business need. Equipped with advanced technology exclusive to Epson, these scanners enhance your business productivity, higher volume and faster speed, exceeding expectations.



# 3LCD PROJECTOR



# 3LCD PROJECTOR

## MENGAPA MEMILIH 3LCD PROJECTOR ?

Projektor Epson 3LCD menghadirkan warna-warna menakjubkan dengan tingkat kecerahan yang seimbang, realistis, dan hasil gambar yang lebih hidup. Tidak heran jika proyektor Epson adalah pilihan utama masyarakat.



## EPSON 3LCD TECHNOLOGY UNTUK WARNA CERAH & LEBIH NYATA

3LCD projectors offer brighter and more accurate as they produce different shades and hues by filtering, then mixing beams of the three primary colours (red, green and blue).

In a 3LCD projector, white light is first split into the three beams of primary colours. Each beam is then filtered through its own LCD that will give each individual pixel of the image its exact brightness for each colour. The colour beams are then perfectly recombined in a prism before being projected out as a complete image.

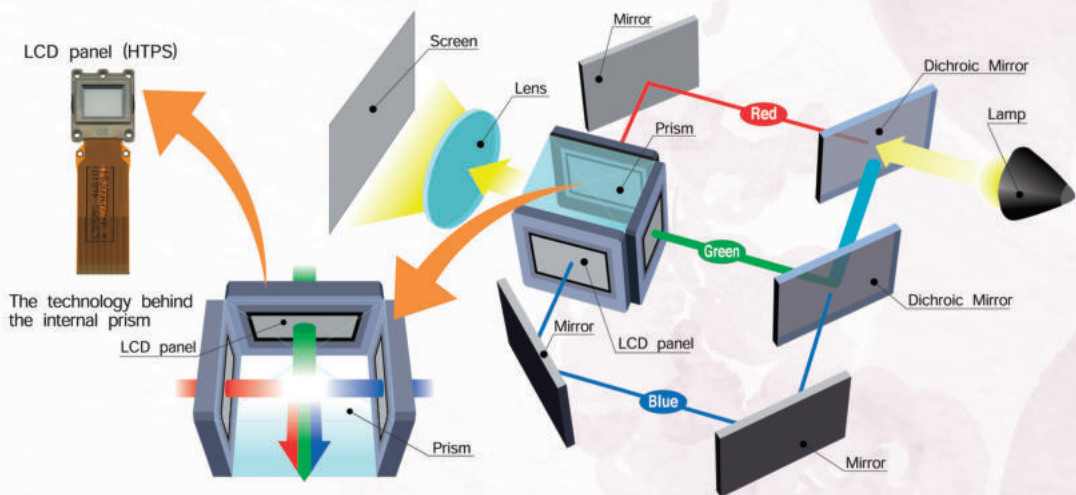

# 3LCD PROJECTOR

Small Sized Rooms

3LCD PROJECTOR

## EB-E01



Brightness 3,300 lm	Resolution XGA	Contrast 15,000:1
Light Source Life 6,000/12,000 hrs	Keystone ±30° (V) / ±30° (H)	Connectivity USB Type-B x 1, VGA x 1, HDMI x 1
Network N/A	Power Consumption 327W / 225W	Weight 2.4 kg



12,000 Hours  
Lamp Life in Eco Mode



Split Screen

## EB-X06



Brightness 3,600 lm	Resolution XGA	Contrast 16,000:1
Light Source Life 6,000/12,000 hrs	Keystone ±30° (V) / ±30° (H)	Connectivity USB Type-B x 1, VGA x 1, HDMI x 1
Network Optional (ELPAP11)	Power Consumption 327W / 225W	Weight 2.5 kg



12,000 Hours  
Lamp Life in Eco Mode



Split Screen



Auto Vertical  
Keystone



Horizontal  
Keystone Adjuster



Wireless  
iProjection

# 3LCD PROJECTOR

## EB-E10



Brightness 3,600 lm	Resolution XGA	Contrast 15,000:1
Light Source Life 6,000/12,000 hrs	Keystone $\pm 30^\circ$ (V) / $\pm 30^\circ$ (H)	Connectivity USB Type-B x 1, VGA x 1, HDMI x 1
Network N/A	Power Consumption 327W / 225W	Weight 2.4 kg



12,000 Hours  
Lamp Life in Eco Mode



Split Screen

## EB-E500

**E500** untuk Indonesia



Brightness 3,300 lm	Resolution XGA	Contrast 15,000:1
Light Source Life 6,000/12,000 hrs	Keystone $\pm 30^\circ$ (V) / $\pm 30^\circ$ (H)	Connectivity USB Type-B x 1, VGA x 1, HDMI x 1
Network N/A	Power Consumption 327W / 225W	Weight 2.4 kg



12,000 Hours  
Lamp Life in Eco Mode



Split Screen

# 3LCD PROJECTOR

Small Sized Rooms

3LCD PROJECTOR

## EB-X500

X500 untuk Indonesia



Brightness 3,600 lm	Resolution XGA	Contrast 16,000:1
Light Source Life 6,000/12,000 hrs	Keystone ±30° (V) / ±30° (H)	Connectivity USB Type-A & Bx1 VGA x1, HDMI x1,
Network Optional (ELPAP11)	Power Consumption 327W / 225W	Weight 2.5 kg



12,000 Hours  
Lamp Life in Eco Mode



Split Screen



Auto Vertical  
Keystone



Horizontal Keystone  
Adjuster\*



Wireless  
iProjection

## EB-X51



Brightness 3,800 lm	Resolution XGA	Contrast 16,000:1
Light Source Life 6,000/12,000 hrs	Keystone ±30° (V) / ±30° (H)	Connectivity HDMI in x1, VGA in x1 RCA x1, 2RCA x1 USB Type-A & Bx1
Network Optional (ELPAP11)	Power Consumption 327W / 225W	Weight 2.5 kg



12,000 Hours  
Lamp Life in Eco Mode



Split Screen



Auto Vertical  
Keystone



Horizontal Keystone  
Adjuster\*



Wireless  
iProjection



# 3LCD PROJECTOR

## EB-W06



Brightness 3,700 lm	Resolution WXGA	Contrast 16,000:1
Light Source Life 6,000/12,000 hrs	Keystone ±30° (V) / ±30° (H)	Connectivity HDMI in x1, VGA in x1 RCA x1, 2RCA x1 USB Type-A & Bx1
Network Optional (ELPAP11)	Power Consumption 327W / 225W	Weight 2.5 kg



12,000 Hours  
Lamp Life in Eco Mode



Split Screen



Auto Vertical  
Keystone



Horizontal Keystone  
Adjuster\*



Wireless  
iProjection

## EB-W51



Brightness 4,000 lm	Resolution WXGA	Contrast 16,000:1
Light Source Life 6,000/12,000 hrs	Keystone ±30° (V) / ±30° (H)	Connectivity HDMI in x1, VGA in x1 RCA x1, 2RCA x1 USB Type-A & Bx1
Network Optional (ELPAP11)	Power Consumption 327W / 225W	Weight 2.5 kg



12,000 Hours  
Lamp Life in Eco Mode



Split Screen



Auto Vertical  
Keystone



Horizontal Keystone  
Adjuster\*



Wireless  
iProjection

# 3LCD PROJECTOR

Small Sized Rooms

3LCD PROJECTOR

## EB-FH52



<b>Brightness</b> 4,000 lm	<b>Resolution</b> 1080p	<b>Contrast</b> 16,000:1
<b>Light Source Life</b> 5,500/12,000 hrs	<b>Keystone</b> ±30° (V) / ±30° (H)	<b>Connectivity</b> HDMI in x2, VGA in x1 RCA x1, 2RCA x1 USB Type-A & Bx1
<b>Network</b> Built-in Support Screen Mirroring	<b>Power Consumption</b> 327W / 225W	<b>Weight</b> 3.1 kg



12,000 Hours  
Lamp Life in Eco Mode



Split Screen



Auto Vertical  
Keystone



Horizontal Keystone  
Slider



Wireless iProjection  
/ Screen Mirroring



Full HD  
Resolution

## EB-972



<b>Brightness</b> 4,100 lm	<b>Resolution</b> XGA	<b>Contrast</b> 16,000:1
<b>Light Source Life</b> 6,500/17,000 hrs	<b>Keystone</b> ±30° (V) / ±30° (H)	<b>Connectivity</b> HDMI in x2, VGA in x1, VGA out x1, RCA in x1, 2RCA x1 Stereo Mini Jack in x2 USB Type-A & Bx1
<b>Network</b> Optional (ELPAP11)	<b>Power Consumption</b> 327W / 225W	<b>Weight</b> 3.1 kg



17,000 Hours  
Lamp Life in Eco Mode



Split Screen



Auto Vertical  
Keystone



Horizontal Keystone  
Slider



Wireless  
iProjection

# 3LCD PROJECTOR

## EB-982W



Brightness 4,200 lm	Resolution WXGA	Contrast 16,000:1
Light Source Life 6,500/17,000 hrs	Keystone ±30° (V) / ±30° (H)	Connectivity HDMI in x2, VGA in x1, VGA out x1, RCA in x1, 2RCA x1 Stereo Mini Jack in x2 Stereo Mini Jack out x1 USB Type-A & Bx1
Network Optional (ELPAP11)	Power Consumption 327W / 225W	Weight 3.1 kg



17,000 Hours  
Lamp Life in Eco Mode



Split Screen



Auto Vertical  
Keystone



Horizontal Keystone  
Slider



Wireless  
iProjection

### Ultra Portable Projectors

## EB-1785W Gesture Presenter



Brightness 3,200lm	Resolution WXGA	Contrast 10,000:1
Light Source Life 4,000 / 7,000 hrs	Keystone ±45°(V) / ±30°(H)	Connectivity VGA in x1, HDMI in x1 (Support MHL) Stereo Mini Jack in x1 USB Type-A & Bx1
Network Built-in Support Screen Mirroring	Power Consumption 295W / 208W	Weight 1.81 kg



Gesture  
Presenter



NFC



Wireless  
Projection



Real-Time Auto V/H  
Keystone Correction



Split Screen

# 3LCD PROJECTOR

## Ultra Portable Projectors



reddot design award



## EB-1795F Gesture Presenter

<b>Brightness</b> 3,200lm	<b>Resolution</b> 1080p	<b>Contrast</b> 10,000:1
<b>Light Source Life</b> 4,000 / 7,000 hrs	<b>Keystone</b> ±45°(V) / ±30°(H)	<b>Connectivity</b> HDMI in x1 (Support MHL) VGA in x1, RCA x1 Stereo Mini Jack in x1 USB Type-A & Bx1
<b>Network</b> Built-in Support Screen Mirroring	<b>Power Consumption</b> 295W / 208W	<b>Weight</b> 1.83 kg



Gesture Presenter



NFC



Wireless Projection



Real-Time Auto V/H  
Keystone Correction



Split Screen



Full HD

## Mid Size Rooms Projectors



## EB-2265U Gesture Presenter

<b>Brightness</b> 5,500lm	<b>Resolution</b> WUXGA	<b>Contrast</b> 15,000:1
<b>Light Source Life</b> 5,000 / 10,000 hrs	<b>Keystone</b> ±30°(V) / ±30°(H)	<b>Connectivity</b> HDBaset x1, HDMI in x2 (1 Support MHL) VGA in x2, VGA out x1 Stereo Mini Jack in x2 Stereo Mini Jack out x1 2RCA x1, RCA x1, RS-232C x1, RJ45 x1 USB Type-A & Bx1
<b>Network</b> Optional (ELPAP10)	<b>Power Consumption</b> 425W / 323W	<b>Weight</b> 4.7 kg



Gesture Presenter



Multi-PC Projection



Wireless Projection



Split Screen

# 3LCD PROJECTOR



## EB-2155W

<b>Brightness</b> 5,000lm	<b>Resolution</b> WXGA	<b>Contrast</b> 15,000:1
<b>Light Source Life</b> 5,000 / 10,000 hrs	<b>Keystone</b> ±30°(V) / ±30°(H)	<b>Connectivity</b> HDMI in x2 (1 Support MHL) VGA in x2, VGA out x1 Stereo Mini Jack in x2 Stereo Mini Jack out x1 2RCA x1, RCA x1, RS-232C x1, RJ45 x1 USB Type-A & Bx1
<b>Network</b> Optional (ELPAP10)	<b>Power Consumption</b> 405W / 323W	<b>Weight</b> 4.3 kg



Gesture Presenter



Multi-PC Projection



Wireless Projection



Split Screen



## EB-L630U/EB-L730U



Wireless Projection



Flexible 360 degree installation



WUXGA Resolution



Edge Blending Technology

## EB-L630U

<b>Brightness</b> 6,200 lm	<b>Resolution</b> WUXGA (16:10)	<b>Contrast</b> over 2,500,000 : 1
<b>Light Source Life</b> 20,000 hours	<b>Keystone</b> ±30°(V) / ±30°(H)	<b>Connectivity</b> D-Sub 15Pin IN x 2, HDMI In x 2, HDBaseT RJ45 In x 1, D-Sub 15Pin Out x 1, Stereo Mini Jack In x 2, Stereo Mini Jack Out x 1, USB Type A x 1, USB Type B x 1, RS-232C D-Sub 15Pin x 1, Wired Lan RJ45 x 1, HDMI Out x1
<b>Network</b> Built-In	<b>Power Consumption</b> 345W / 258W	<b>Weight</b> Approx 8.4 Kg

## EB-L730U

<b>Brightness</b> 7,000 lm	<b>Resolution</b> WUXGA (16:10)	<b>Contrast</b> over 2,500,000 : 1
<b>Light Source Life</b> 20,000 hours	<b>Keystone</b> ±30°(V) / ±30°(H)	<b>Connectivity</b> D-Sub 15Pin IN x 2, HDMI In x 2, HDBaseT RJ45 In x 1, D-Sub 15Pin Out x 1, Stereo Mini Jack In x 2, Stereo Mini Jack Out x 1, USB Type A x 1, USB Type B x 1, RS-232C D-Sub 15Pin x 1, Wired Lan RJ45 x 1, HDMI Out x1
<b>Network</b> Built-In	<b>Power Consumption</b> 345W / 258W	<b>Weight</b> Approx 8.4 Kg

# 3LCD PROJECTOR

Ultra Portable Projectors

## EB-2065



<b>Brightness</b> 5,500lm	<b>Resolution</b> XGA	<b>Contrast</b> 15,000:1
<b>Light Source Life</b> 5,000 / 10,000 hrs	<b>Keystone</b> ±30°(V) / ±30°(H)	<b>Connectivity</b> HDMI in x2 (1 Support MHL) VGA in x2, VGA out x1 2RCA x1, RCA x1, RS-232C x1, RJ45 x1 Stereo Mini Jack in x2 Stereo Mini Jack out x1 USB Type-A & Bx1
<b>Network</b> Optional (ELPAP10)	<b>Power Consumption</b> 425W / 323W	<b>Weight</b> 4.4 kg



Gesture  
Presenter



Multi-PC  
Projection



Wireless  
Projection



Split Screen

## EB-L520U



<b>Brightness</b> 5,200lm	<b>Resolution</b> WUXGA (1920 x 1200)	<b>Contrast</b> over 2,500,000 : 1
<b>Light Source Life</b> 20,000 hours	<b>Keystone</b> ±30°(V) / ±30°(H)	<b>Connectivity</b> D-Sub 15Pin IN x 2, HDMI In x 2, HDBaseT RJ45 In x 1, D-Sub 15Pin Out x 1, Stereo Mini Jack In x 2, Stereo Mini Jack Out x 1, USB Type A x 1, USB Type B x 1, RS-232C D-Sub 9Pin x 1, Wired Lan RJ45 x 1,
<b>Network</b> Optional (ELPAP11)	<b>Power Consumption</b> 293W/233W	<b>Weight</b> Approx 7.7 Kg



Split Screen

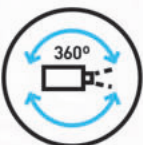

Flexible  
360 degree  
installation

# 3LCD PROJECTOR

Business Projector

## EB-L210W



<b>Brightness</b> 4,500lm / 3,100lm	<b>Resolution</b> WXGA (1280 x 800)	<b>Contrast</b> Over 2,500,000 : 1
<b>Light Source Life</b> 20,000 / 30,000 hrs	<b>Keystone</b> ±30° (V) / ±30° (H)	<b>Connectivity</b> -HDMI 2 (HDCP 2.3) -D-Sub 15Pin (1 (Black) lin common with Computer 2) -RCA 2 (White, Red) -Stereo Mini Jack (2) -USB Type A & B
<b>Network</b> -Wired LAN : RJ45 x 1 (100Mbps) -Wireless : Built-in*2 and Optional (Using ELPAP11)	<b>Power Consumption</b> -Lamp On (Normal / Extended) : 260W / 191W - Standby (Network On / Off) : 2.0W / 0.5W	<b>Weight</b> Approx. 4.2kg



30,000 Hours Lamp Life in Eco Mode



Split Screen



Auto Vertical Keystone



Horizontal Keystone Adjuster



Wi-Fi Connection



## EB-L260F



<b>Brightness</b> 4,600lm / 3,200lm	<b>Resolution</b> Full HD (1080p)	<b>Contrast</b> Over 2,500,000 : 1
<b>Light Source Life</b> 20,000 / 30,000 hrs	<b>Keystone</b> ±30° (V) / ±30° (H)	<b>Connectivity</b> -HDMI 2 (HDCP 2.3) -D-Sub 15Pin (1 (Black) lin common with Computer 2) -RCA 2 (White, Red) -Stereo Mini Jack (2) -USB Type A & B
<b>Network</b> -Wired LAN : RJ45 x 1 (100Mbps) -Wireless : Built-in*2 and Optional (Using ELPAP11)	<b>Power Consumption</b> -Lamp On (Normal / Extended) : 260W / 191W - Standby (Network On / Off) : 2.0W / 0.5W	<b>Weight</b> Approx. 4.2kg



30,000 Hours Lamp Life in Eco Mode



Split Screen



Auto Vertical Keystone



Horizontal Keystone Adjuster



Wi-Fi Connection



# 3LCD PROJECTOR

## Short Throw Projectors



## EB-L210SW

<b>Brightness</b> 4,000lm / 2,800lm	<b>Resolution</b> WXGA (1280 x 800)	<b>Contrast</b> over 2,500,000 : 1
<b>Light Source Life</b> Type : Laser Diode Life (Normal / Quiet / Extended) : 20,000 / 20,000 / 30,000 hrs	<b>Keystone</b> ±15°(V) / ±15°(H)	<b>Connectivity</b> HDMI 2 (HDCP 2.3) D Sub 15 Pin RCA Stereo Mini Jack USB Type A & B
<b>Network</b> Wired LAN : RJ45 x 1 (100Mbps) Wireless : Built-in*2 and Optional wireless (using ELPAP11)	<b>Power Consumption</b> Lamp On (Normal / Extended) 260W / 191W Standby (Network On / Off) 2.0W / 0.5W	<b>Weight</b> Approx 4.6 Kg



Short Throw



30,000 Light Hours



Wi-Fi Connection



Multi-PC Projection

## EB-L210SF



<b>Brightness</b> 4,000lm / 2,800lm	<b>Resolution</b> Full HD (1080p)	<b>Contrast</b> over 2,500,000 : 1
<b>Light Source Life</b> Type : Laser Diode Life (Normal / Quiet / Extended) : 20,000 / 20,000 / 30,000 hrs	<b>Keystone</b> ±15°(V) / ±15°(H)	<b>Connectivity</b> HDMI 2 (HDCP 2.3) D Sub 15 Pin RCA Stereo Mini Jack USB Type A & B
<b>Network</b> Wired LAN : RJ45 x 1 (100Mbps) Wireless : Built-in*2 and Optional wireless (using ELPAP11)*	<b>Power Consumption</b> Lamp On (Normal / Extended) 260W / 191W Standby (Network On / Off) 2.0W / 0.5W	<b>Weight</b> Approx 4.6 Kg



Short Throw



30,000 Light Hours



Wi-Fi Connection



Multi-PC Projection



# 3LCD PROJECTOR

## EB-L630SU



Brightness 6,000 lm	Resolution WUXGA (16:10)	Contrast over 2,500,000 : 1
Light Source Life 20,000 hours	Keystone ±30°(V) / ±30°(H)	Connectivity D-Sub 15Pin IN x 2, HDMI In x 2, HDbaseT RJ45 In x 1, D-Sub 15Pin Out x 1, Stereo Mini Jack In x 2, Stereo Mini Jack Out x 1, USB Type A x 1, USB Type B x 1, RS-232C D-Sub 15Pin x 1, Wired Lan RJ45 x 1, HDMI Out x1
Network Built-In	Power Consumption 345W / 258W	Weight Approx 8.4 Kg



Wireless Projection

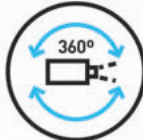

Flexible 360 degree installation



WUXGA Resolution



Edge Blending Technology



## Lightning Scene

## EB-W50



Brightness 3,800 lm	Resolution WXGA (1280 x 800)	Contrast 16,000:1
Light Source Life 10,000 hours (Normal), 17,000 hours (Eco)	Keystone ±30° (V) / ±30° (H)	Connectivity D-Sub 15 Pin In x 2, HDMI In x 2, D-Sub 15Pin Out x 1, Stereo Mini Jack In x 2, Stereo Mini Jack Out x 1, USB Type A x 1, USB Type B x 1, RS-232C D-Sub 9pin x 1, Wired LAN RJ45 x 1
Network Wireless ELPAP10 (Optional)	Power Consumption 285 W / 218 W	Weight 3.1 kg



17,000 Hours Lamp Life in Eco Mode



Split Screen



Auto Vertical Keystone



Dust Resistance Design



USB Direct Playback

# 3LCD PROJECTOR

## Lighting Scene

### EB-U50



<b>Brightness</b> 3,700 lm	<b>Resolution</b> WUXGA	<b>Contrast</b> 16,000:1
<b>Light Source Life</b> 10,000/17,000 hrs	<b>Keystone</b> ±30° (V) / ±30° (H)	<b>Connectivity</b> HDMI in x2, VGA in x2 VGA out x1, RJ45 x1 Stereo Mini Jack in x2 Stereo Mini Jack out x1 USB Type-A & Bx1
<b>Network</b> Built-in	<b>Power Consumption</b> 285W / 218W	<b>Weight</b> 3.1 kg



17,000 Hours  
Lamp Life in Eco Mode



Split Screen



Auto Vertical  
Keystone



Dust Resistance  
Design



USB Direct  
Playback

### EV-110/EV-115



EV-110 (White)

EV-115 (Black)

<b>Brightness</b> 2,200lm	<b>Resolution</b> WXGA	<b>Contrast</b> >2,500,000:1
<b>Laser Light Source</b> 20,000 hrs	<b>Keystone</b> ±45°(V) / ±40°(H)	<b>Connectivity</b> HDMI in x1 SD Card x1, RJ45 x1 Stereo Mini Jack out x1 USB Type-A & Bx1
<b>Network</b> Built-in	<b>Power Consumption</b> 149W / 112W	<b>Weight</b> 6.9 kg (Exclude Direct Mount)

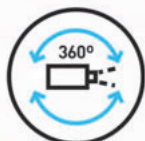

Flexible  
Installation

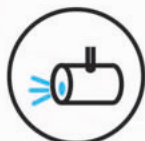

Sleek Spotlight  
Design

# 3LCD PROJECTOR



## EB-800F / 805F

<b>Brightness</b> 5,000 lm	<b>Resolution</b> 1080p	<b>Contrast</b> over 2,500,000 : 1
<b>Light Source Life</b> 20,000 hours (Normal), 30,000 hours (Extended)	<b>Keystone</b> ±3° (V) / ±3° (H)	<b>Connectivity</b> D-Sub 15Pin In x 2, Composite In RCA x 1 (Yellow), HDMI In x 3 (HDCP2.3), HDBaseT x 1 (HDCP2.3), D-Sub 15Pin Out x 1, HDMI Out x 1, Stereo Mini Jack In x 3, Stereo Mini Jack Out x 1, Rs-232C D-Sub 9Pin x 1, USB Type A x 2, USB Type B x 1, Wired Lan RJ45 x 1
<b>Network</b> Wireless Lan x 1 USB Type A	<b>Power Consumption</b> 366 W / 262 W	<b>Weight</b> Approx 9.4 Kg



Full HD Resolution



Ultra short-throw  
130 inch @80,3 cm



Multi-PC Projection



PC free USB memory

## Ultra Short Throw Lamp Projectors

## EB-685W



<b>Brightness</b> 3,500 lm	<b>Resolution</b> WXGA	<b>Contrast</b> 14,000:1
<b>Light Source Life</b> 5,000/10,000 hrs	<b>Keystone</b> ±3° (V) / ±3° (H)	<b>Connectivity</b> HDMI in x3, RCA x1 VGA in x2, VGA out x1 RS-232C x1, RJ45 x1 Stereo Mini Jack out x1 Stereo Mini Jack in x3 USB Type-A & Bx1 Microphone x1
<b>Network</b> Optional (ELPAP10)	<b>Power Consumption</b> 354W / 309W	<b>Weight</b> 5.7 kg



Ultra-Short Throw



10,000 Hours Lamp Life in Eco Mode



Multi-PC Projection

# 3LCD PROJECTOR

## Ultra Short Throw Lamp Projectors



**NEW**  
PRODUCT

## EB-760W

<b>Brightness</b> 4,100lm / 2,800lm	<b>Resolution</b> WXGA (1280 x 800)	<b>Contrast</b> over 2,500,000 : 1
<b>Light Source Life</b> Type : Laser Diode Life (Normal / Quiet / Extended) : 20,000 / 20,000 / 30,000 hrs	<b>Keystone</b> ±3°(V) / ±3°(H)	<b>Connectivity</b> HDMI Stereo Mini Jack USB Type A & B
<b>Network</b> Wired LAN RJ45 x 1 (100Mbps) Wireless Built-in and Optional (using ELPAP11)	<b>Power Consumption</b> Lamp On (Normal / Extended) 263W / 199W Standby (Network On / Off) 2.0W / 0.5W	<b>Weight</b> Approx 5.9 Kg



Ultra-Short Throw



20,000 Light Hours



Wireless Connection



Multi-PC Projection

## EB-770F



**NEW**  
PRODUCT

<b>Brightness</b> 4,100lm / 2,800lm	<b>Resolution</b> Full HD (1080p)	<b>Contrast</b> over 2,500,000 : 1
<b>Light Source Life</b> Type : Laser Diode Life (Normal / Quiet / Extended) : 20,000 / 20,000 / 30,000 hrs	<b>Keystone</b> ±3°(V) / ±3°(H)	<b>Connectivity</b> HDMI Stereo Mini Jack USB Type A & B
<b>Network</b> Wired LAN RJ45 x 1 (100Mbps) Wireless Built-in and Optional (using ELPAP11)	<b>Power Consumption</b> Lamp On (Normal / Extended) 263W / 199W Standby (Network On / Off) 2.0W / 0.5W	<b>Weight</b> Approx 5.9 Kg



Ultra-Short Throw



20,000 Light Hours



Wireless Connection



Multi-PC Projection



Full HD

# 3LCD PROJECTOR

## EB-760Wi



**NEW**  
PRODUCT

<b>Brightness</b> 4,100lm / 2,800lm	<b>Resolution</b> WXGA (1280 x 800)	<b>Contrast</b> over 2,500,000 : 1
<b>Light Source Life</b> Type : Laser Diode Life (Normal / Quiet / Extended) : 20,000 / 20,000 / 30,000 hrs	<b>Keystone</b> ±3°(V) / ±3°(H)	<b>Connectivity</b> HDMI Stereo Mini Jack USB Type A & B
<b>Network</b> Wired LAN RJ45 x 1 (100Mbps) Wireless Built-in and Optional (using ELPAP11)	<b>Power Consumption</b> Lamp On (Normal / Extended) 263W / 199W Standby (Network On / Off) 2.0W / 0.5W	<b>Weight</b> Approx 6.0 Kg



Ultra-Short Throw



20,000 Light Hours



Wireless Connection



Multi-PC Projection



Optional Finger Touch Interactive

## EB-770Fi



**NEW**  
PRODUCT

<b>Brightness</b> 4,100lm / 2,800lm	<b>Resolution</b> Full HD (1080p)	<b>Contrast</b> over 2,500,000 : 1
<b>Light Source Life</b> Type : Laser Diode Life (Normal / Quiet / Extended) : 20,000 / 20,000 / 30,000 hrs	<b>Keystone</b> ±3°(V) / ±3°(H)	<b>Connectivity</b> HDMI Stereo Mini Jack USB Type A & B
<b>Network</b> Wired LAN RJ45 x 1 (100Mbps) Wireless Built-in and Optional (using ELPAP11)	<b>Power Consumption</b> Lamp On (Normal / Extended) 263W / 199W Standby (Network On / Off) 2.0W / 0.5W	<b>Weight</b> Approx 6.0 Kg



Ultra-Short Throw



20,000 Light Hours



Wireless Connection



Multi-PC Projection



Full HD



Finger Touch Interactive

# 3LCD PROJECTOR

Ultra Short Throw Lamp Projectors

3LCD PROJECTOR

## EB-695Wi Touch Interactive



<b>Brightness</b> 3,500 lm	<b>Resolution</b> WXGA	<b>Contrast</b> 14,000:1
<b>Light Source Life</b> 5,000/10,000 hrs	<b>Keystone</b> ±3° (V) / ±3° (H)	<b>Connectivity</b> HDMI in x3, RCA x1 VGA in x2, VGA out x1 RS-232C x1, RJ45 x1 Stereo Mini Jack out x1 Stereo Mini Jack in x3 Interactive Sync x1 USB Type-A & Bx1 Microphone x1
<b>Network Optional (ELPAP10)</b>	<b>Power Consumption</b> 354W / 309W	<b>Weight</b> 5.8 kg



Ultra-Short Throw



10,000 Hours Lamp Life in Eco Mode



Finger Touch Interactive



Multi-PC Projection

## EB-1485Fi Touch Interactive



<b>Brightness</b> 5,000lm	<b>Resolution</b> 1080p	<b>Contrast</b> >2,500,000:1
<b>Laser Light Source</b> 20,000 hrs	<b>Keystone</b> ±3°(V) / ±3°(H)	<b>Connectivity</b> HDMI in x3 (HDCP2.3) HDBaseT x1 (HDCP2.3) HDMI out x1, RJ45 x1 VGA in x2, VGA out x1 Stereo Mini Jack in x3 Stereo Mini Jack out x1 RCA x1, RS-232C x1 Interactive Sync x1 Microphone x1, USB Type-A & Bx1
<b>Network Built-in Support Screen Mirroring</b>	<b>Power Consumption</b> 366W / 262W	<b>Weight</b> 9.3 kg



Ultra-Short Throw



20,000 Light Hours



Wireless Connection



Multi-PC Projection



Finger Touch Interactive



Full HD

# 3LCD PROJECTOR

Large Venues

## EB-PU1006W/ EB-PU1007W



<b>Brightness</b> 6.000 lm (PU1006W) 7.000 lm (PU1007W)	<b>Resolution</b> WUXGA	<b>Contrast</b> >2,500,000:1
<b>Laser Source Life</b> 20,000 hrs	<b>Keystone</b> ±45°(V) / ±30°(H)	<b>Connectivity</b> D-Sub 15Pin in x1, HDMI in x1, DVI-D in x1, HDBaseT, USB Type A x2 USB Type B x1, RS-232C x1, Stereo Mini Out x1, RJ45
<b>Network</b> Wireless Optional (ELPAP11)	<b>Power Consumption</b> 367W (PU1006W) 431W (PU1007W)	<b>Weight</b> 15.4 kg (PU1006W) 16.3 kg (PU1007W)

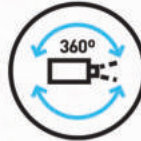

HDBaseT

Edge  
Blending

Flexible  
Installation

NFC

## EB-PU1008B/ EB-PU2010B



<b>Brightness</b> 8.500 lm (PU1008B) 10.000 lm (PU2010B)	<b>Resolution</b> WUXGA	<b>Contrast</b> >2,500,000:1
<b>Laser Source Life</b> 20,000 hrs	<b>Keystone</b> ±45°(V) / ±30°(H)	<b>Connectivity</b> D-Sub 15Pin in x1, HDMI in x1, DVI-D in x1, HDBaseT, USB Type A x2 USB Type B x1, RS-232C x1, Stereo Mini Out x1, RJ45, SDI x1 (for PU2010B)
<b>Network</b> Wireless Optional (ELPAP11)	<b>Power Consumption</b> 535W	<b>Weight</b> 16.3 kg (PU1008B) 16.8 kg (PU2010B)



HDBaseT

Edge  
Blending

Flexible  
Installation

NFC

# 3LCD PROJECTOR

Large Venues

3LCD PROJECTOR



## EB-PU2213B

Brightness 13,000lm	Resolution WUXGA	Contrast >2,500,000:1
Laser Source Life 20,000 hrs	Keystone ±45°(V) / ±30°(H)	Connectivity HDMI in x1, SDI x1 HDBaseT x1 VGA in x1, VGA out x1 5BNC x1, DVI-D x1 RS-232C x1, RJ45 x1 Stereo Mini Jack in x3 Stereo Mini Jack out x1 USB Type-A & Bx1
Network Wireless optional (ELPAP10)	Power Consumption 908W / 597W	Weight 21.9 kg



HDBaseT

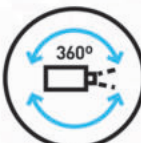

Flexible  
Installation



Edge  
Blending

## EB-PU2216B



Brightness 16,000lm	Resolution WUXGA	Contrast >2,500,000:1
Laser Source Life 20,000 hrs	Keystone ±45°(V) / ±30°(H)	Connectivity HDMI in x1 HDBaseT x1 VGA in x1, VGA out x1 5BNC x1, DVI-D x1 RS-232C x1, RJ45 x1 Stereo Mini Jack in x3 Stereo Mini Jack out x1 USB Type-A & Bx1
Network Wireless optional (ELPAP10)	Power Consumption 1024W / 647W	Weight 22.3 kg



HDBaseT



Edge  
Blending



Flexible  
Installation



# 3LCD PROJECTOR

## EB-PU2220B



Brightness 20,000lm	Resolution WUXGA	Contrast >2,500,000:1
Laser Source Life 20,000 hrs	Keystone ±44°(V) / ±30°(H)	Connectivity HDBaseT x1, RS-232C x1 VGA in x1, VGA out x1 BNC in x1, SDI in x1 Expansion Board ELPIF01 (HDMI in x1, DVI-D x1, DC-Out x1) Expansion Board ELPIF03 (Display port in x2) BNC out x1 RJ-45 x1 (etherCON) USB Type-A & B x1
Network Built-in	Power Consumption 1860W / 1123W	Weight 49.6 kg

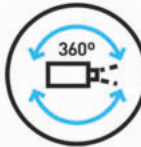

HDBaseT

Flexible  
Installation

Edge  
Blending

## EB-L30000UNL



Brightness 30,000lm	Resolution WUXGA	Contrast >2,500,000:1
Laser Source Life 20,000 hrs	Keystone ±45°(V) / ±30°(H)	Connectivity HDBaseT x1 (HDCP 2.2) VGA in x1, VGA out x1 SDI in x1, 5BNC x1 DVI-D x1 (Single link, HDCP 1.4) HDMI in x1 (HDCP 2.2) SDI out x1, RS-232C x1 Remote x1, RJ45 x1 USB Type-A & B x1
Network Optional	Power Consumption 2325W / 1511W	Weight 69.9 kg

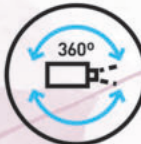

HDBaseT

Flexible  
Installation

Edge  
Blending

# 3LCD PROJECTOR

Home Entertainment Projectors



## EpiqVision EF-11

<b>Brightness</b> 1,000lm	<b>Resolution</b> Full HD (1080p)	<b>Contrast</b> > 2,500,000:1
<b>Weight</b> Approx 1.2 kg	<b>Keystone</b> ±34° (V) / ±40° (H)	<b>Connectivity</b> HDMI x1 (HDCP 1.4) Stereo Mini Jack Out x1 USB Type-A & Type-B x1



Auto Vertical Keystone



Miracast

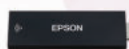

Android TV™ Dongle (ELPAP12)  
sudah ada di dalam unit nya



## EpiqVision EF-12

<b>Brightness</b> 1,000lm	<b>Resolution</b> Full HD (1080p)	<b>Contrast</b> > 2,500,000:1
<b>Weight</b> Approx 2.1 kg	<b>Keystone</b> ±34° (V) / ±40° (H)	<b>Connectivity</b> HDMI x1 (HDCP 1.4) Stereo Mini Jack Out x1 USB Type-A & Type-B x1



AndroidTV



Miracast

sound by YAMAHA

# 3LCD PROJECTOR

## EH-TW6250



<b>Brightness</b> 2,800lm / 1,900lm	<b>Resolution</b> Full HD (1080P)	<b>Contrast</b> 35,000 : 1
<b>Light Source Life</b> Type Lamp: 200W UHE Lamp Life*1 Normal: 4,500 / Eco: 7,500 hours	<b>Keystone</b> ±30°(V) / ±30°(H)	<b>Connectivity</b> HDMI USB Type B
<b>Network</b> -	<b>Power Consumption</b> Lamp On (Normal / Quiet, Extended) 301W / 231W Energy Saving 0.3W	<b>Weight</b> Approx 4.1 Kg



4K PRO-UHD



Auto Vertical Keystone



AndroidTV

## EH-LS800B



<b>Brightness</b> 4,000lm / 2,000lm	<b>Resolution</b> 4K	<b>Contrast</b> Over 2,500,000:1
<b>Light Source Life</b> 20,000 hours (Normal / Eco)	<b>Keystone</b> -	<b>Connectivity</b> HDMI USB Type A
<b>Network</b> -	<b>Power Consumption</b> Lamp On (Normal / Quiet, Extended) 335W / 210W Standby (Network On / Off) 2.0W / 0.4 W	<b>Weight</b> Approx 7.2 Kg



AndroidTV

sound by YAMAHA

Chromecast built-in

# 3LCD PROJECTOR

Home Entertainment

## EpiqVision Ultra EH-LS300B

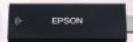

Android TV™ Dongle (ELPAP12)  
sudah ada di dalam unit nya



Brightness 3,600lm	Resolution Full HD (1080p)	Contrast > 2,500,000:1
Laser Light Source 20,000 hrs	Keystone 8 point arc correction	Connectivity HDMI x2 (SMF, HDMI2=ARC) Audio Out (Bluetooth & Optical Out) USB Type-A x 1 USB Type-B Mini x1
Wireless Built-in	Power Consumption 278 W	Weight & Dimension Approx. 7.2 kg 400x467x133 mm



sound by YAMAHA

Chromecast built-in

## EH-LS12000B



Brightness 2,700lm	Resolution 4K	Contrast > 2,500,000:1
Laser Light Source 20,000 hrs	Keystone ±30° (V) / ±30° (H)	Connectivity HDMI x 2 USB Type-A x 2 USB Type-B x 1 Stereo Mini Jack Out x 1
Network N/A	Power Consumption 302W/198W	Dimension Approx. 12.7kg 447 x 520 x 169 mm



**4K**



Lens Shift

# 3LCD PROJECTOR

## EH-TW7000



<b>Brightness</b> 3,000lm	<b>Resolution</b> Full HD (1080p)	<b>Contrast</b> 40,000:1
<b>Light Source Life</b> 3,500 hrs / 5,000 hrs	<b>Keystone</b> ±30° (V) / ±30° (H)	<b>Connectivity</b> HDMI x 2 (HDCP 2.2) Stereo Mini Jack Out x 1 USB Type-A x 2 Type-B Mini x 1 Wireless ELPAP10 (Optional)
<b>Max Screen Size</b> 500 inch	<b>Power Consumption</b> 368W/280W	<b>Weight &amp; Dimension</b> Approx 6.6 kg 410 x 310 x 157 mm



Vertical & Horizontal  
Keystone Adjuster



HDMI



## EH-TW9400



<b>Brightness</b> 2,600lm	<b>Resolution</b> Full HD (1080p)	<b>Contrast</b> 1,200,000:1
<b>Light Source Life</b> 3,500 hrs / 5,000 hrs	<b>Keystone</b> ±30° (V)	<b>Connectivity</b> HDMI x 2 (HDCP 2.2) Stereo Mini Jack Out x 1 USB Type-A x 2 Type-B Mini x 1 Wireless ELPAP10 (Optional)
<b>Max Screen Size</b> 300 inch	<b>Power Consumption</b> 355W / 271W	<b>Weight &amp; Dimension</b> Approx. 11.2 kg 520 x 170 x 450 mm



Lens Shift

# 3LCD PROJECTOR

Cross Over

3LCD PROJECTOR



## CO-FH01

Brightness 3,000lm / 2,000lm	Resolution Full HD (1080P)	Contrast -
Light Source Life -	Keystone ±30°(V) / ±30°(H)	Connectivity HDMI USB Type A & B
Network Wireless (Optional)	Power Consumption 270W / 214W	Weight Approx 2.4 Kg

**Full HD**  
**1080p**

## CO-FH02



Brightness 3,000lm / 2,000lm	Resolution Full HD (1080P)	Contrast -
Light Source Life Type Lamp (Fixed), 188 W UHE Life (Normal/ Extended) 6,000 / 12,000 hours (Normal / ECO)	Keystone ±30°(V) / ±30°(H)	Connectivity USB Type A & B
Network -	Power Consumption 270W / 214W	Weight Approx 2.6 Kg

**Full HD**  
**1080p**



Chromecast built-in

# 3LCD PROJECTOR

## Wireless Presenter



### ELPWP10

Ideal for small-group presentation, Selected Epson projectors offers an affordable and versatile wireless presentation system for offices.

[Contents: Wireless Dongle x2, ELPAP11 x1, Tray x1]



### ELPWP20

- Cable-free collaboration Wireless presentation system for maximum ease of use
- Instant multi-screen sharing Display up to four devices simultaneously
- Display-agnostic Compatible with all displays with a HDMI input
- Compatibility with all major OSs Works with Windows, Mac, Android, iOS and Chromebooks
- Miracast built in For simple sharing on compatible devices

[Contents: Wireless Dongle x2, Base Station x1, Tray x1, IR Remote x1]



### ELPWT01

- Power Consumption 5 VDC / 0.5 A
- Operating Temperature 0 to +40°C (Humidity of 20 to 80%, No condensation)
- Storage Temperature -20 to +70°C (Humidity of 0 to 95%, No condensation)
- Operating Altitude 0 to 3,000 m
- Dimensions Width 63.5 x Height 11 x Depth 175 mm (excluding USB conversion adapter)
- Weight Approx. 53 g

[Contents: Wireless Dongle x1]

# TM PRINTER





# TM PRINTER

## Mobile (Portable) Receipt Printer

### TM-M30II

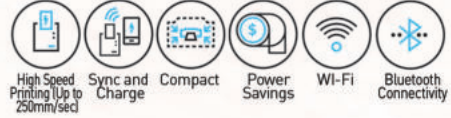

NEW  
PRODUCT

Print Method	Thermal Line Printing
Print Speed	250 mm/sec
Interface	USB + Ethernet/ USB + Ethernet + Bluetooth/ 3.0 EDR
Paper Dimension	Roll Paper: 57.5 ± 0.5 (w) x Ø 40.4 mm
Operating System	Mobile IOS, Android and Windows, (security LEVELWEP, WPA, WPA2-Personal/Enterprise)
Power Consumption	32.4 W
Overall Dimension	127 x 127 x 135 mm
Weight	1.3 Kg

COMING SOON



### EU-M30

Print Method	Thermal Line Printing
Print Speed	250 mm/sec
Interface	USB 2.0 Type B, RS-232C
Paper Size	58 mm - 80 mm (Width)
Paper size roll paper	57.50 ± 0.50 (W) mm x dia 18.00 mm, 57.50 ± 0.50 (W) mm x dia 83.00 mm, 79.50 ± 0.50 (W) mm x dia 18.00 mm, 79.50 ± 0.50 (W) mm x dia 83.00 mm
Operating System	Mobile IOS, Android and Windows, (security LEVELWEP, WPA, WPA2-Personal/Enterprise)
Power Supply	AC adapter, C, EURO AC cable
Overall Dimension	127 x 131 x 127 mm
Weight	1.3 kg



# TM PRINTER

## Mobile (Portable) Receipt Printer

TM PRINTER

### TM-P20

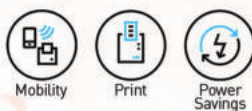

- Print Method** Thermal Line Printing
- Print Speed** 100 mm/sec (Receipt Version)
- Character Size** font A: 1.5 x 3.0 mm; font B: 1.12 x 3.0 mm; font C: 1.12 x 2.1 mm; font D: 1.25 x 3.0 mm; font E: 1.0 x 2.0 mm
- Paper Dimension** Roll Paper: 57.5 ± 0.5 (w) x Ø 40.4 mm
- Operating System** Mobile IOS, Android and Windows, (security LEVELWEP, WPA, WPA2-Personal/Enterprise)
- Power Consumption** Wi-Fi: 9 hours (energy saving mode); 16 hours | Bluetooth: 26 hours
- Overall Dimension** 79.0 x 119.8 x 43.6 mm
- Option** Single Printer Charger/Cradle (OT-SC20), Battery Pack (OT-BY20), Padded Case (OT-PC20), Battery Spacer (OT-BS20)

## Receipt Printers

### TM-M10

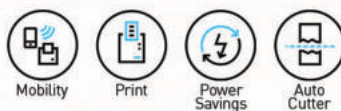

FOR PROJECT ONLY



- Print Method** Thermal Line Printing
- Print Speed** 150 mm/sec
- Character Size** Font A: 1.25 x 3.00 mm; Font B: 1.13 x 3.00 mm; Font C: 0.88 x 2.13 mm
- Paper Dimension** Roll Paper: 79.5 ± 0.5 (W) x Ø 83; 57.5 ± 0.5 (W) x Ø 83
- Operating System** Windows (APD, OPOS, epos SDK); Mac Drivers; Linux Cup Drivers; iOS/Android/Web (epos SDK)
- Power Consumption** Approx. 1.5 A (mean)
- Overall Dimension** 127 x 127 x 127 mm
- Option** External Buzzer (OT-BZ20); Wall Hanging Bracket (OT-WH30)

# TM PRINTER

## TM-M30II-SL



Mobility



Print



Power Saving



Auto Cutter



**Print Method** Thermal line printing  
**Print Speed** 200 mm/sec (Receipt Version)  
**Character Size** ANK Font A: 1.25 x 3 mm (Default); ANK Font B: 1.13 x 3 mm; Kanji Font: 3 x 3 mm

**Paper Dimension** Roll paper: 79.5 ± 0.5 (W) x Ø 83, 57.5 ± 0.5 (W) x Ø 83  
**Interface** Built-in USB + Ethernet 10/100Base-T/TX (Ethernet Model)

**Power Consumption** Approx. 1.5 A (mean)  
**Overall Dimension** 127 x 127 x 127 mm  
**Option** External Buzzer (OT-BZ20); Wall Hanging Bracket (OT-WH30)

## TM-U220



Print



Power Saving



**Print Method** 9-pin, serial impact dot matrix  
**Print Speed** Approx. 4.7 lps (at 40 columns, 16 cpi), 6.0 lps (at 30 columns, 16 cpi)  
**Character Size** Font A: 1.6 mm (W) x 3.1 mm (H)  
Font B: 1.2 mm (W) x 3.1 mm (H)  
**Paper Dimension** Roll Paper : 57.5 ± 0.5 (W), 69.5 ± 0.5 (W), 76.0 ± 0.5 (W) x Ø 83.0 mm  
**Interface** RS 232, Bi-directional Parallel, USB, Ethernet  
**Power Consumption** Operating: Approx. 38 W (Mean)  
Standby: Approx. 2.2 W (Mean)  
**Overall Dimension** Type A: 160 (W) x 286 (D) x 157.5 (H) mm  
Type B: 160 (W) x 248 (D) x 138.5 (H) mm  
Type B: 160 (W) x 248 (D) x 138.5 (H) mm  
**Option** Wall hanging bracket model: WH-10 (for type B, D)

# TM PRINTER

## Receipt Printers

### TM-T70II

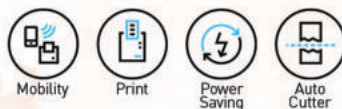

- Print Method** Thermal Line Printing
- Print Speed** Max. 170 mm/sec (80 mm model)  
Max. 200 mm/sec (58 mm model)
- Dot Density** 180 dpi x 180 dpi (ANK model)  
203 dpi x 203 dpi (Japanese / Multi-language model)
- Paper Dimension** Roll Paper: 79.5 mm ± 0.5 mm  
(W) x Ø 83.0 mm / 57.5 mm ± 0.5 mm  
(W) x Ø 83.0 mm
- Interface** USB + RS-232, USB + Parallel,  
USB + Ethernet
- Power Consumption** Approx. 1.8 A (mean)
- Overall Dimension** 125 (W) x 194 (D) x 114 (H) mm
- Option** External buzzer unit, Connector cover

### TM-T82X

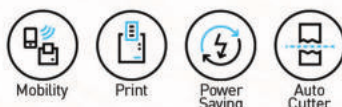

- Print Method** Thermal Line Printing
- Print Speed** Max. 200 mm/sec
- Character Size** 0.88 x 2.13 mm / 1.25 x 3 mm,  
Hanji font: 3 x 3 mm,  
Thai font: 0.88 x 3 mm / 1.25 x 3 mm
- Paper Dimension** Width and Roll Diameter: 79.5 ± 0.5 mm
- Operating System** Windows, Mac, Linux
- Power Consumption** Operating: Approx. 27.8 W  
Standby: Approx. 0.96 W
- Overall Dimension** 192 x 149 x 140 mm
- Option** External buzzer

Also available for 58mm paper width

# TM PRINTER

## TM-T82III



Mobility



Print



Power Saving



Auto Cutter



<b>Print Method</b>	Thermal Line Printing
<b>Print Speed</b>	Max. 250 mm/sec
<b>Character Size</b>	0.88 x 2.13 mm / 1.25 x 3 mm, Hanji font: 3 x 3 mm, Thai font: 0.88 x 3 mm / 1.25 x 3 mm
<b>Paper Dimension</b>	Width: 79.5 ± 0.5mm Roll: 57.5 ± 0.5 x Ø 83.0 mm
<b>Interface</b>	Built-in USB + UIB (Serial or Parallel interface), Ethernet interface
<b>Power Consumption</b>	Operating: Approx. 1.5A Standby: Approx. 0.1A
<b>Overall Dimension</b>	199 x 140 x 146 mm
<b>Option</b>	External Wi-Fi Dongle OT-WL06, External buzzer unit

## T88VI - iHUB



Mobility



Print



Power Saving



Auto Cutter



<b>Print Method</b>	Thermal Line Printing
<b>Print Speed</b>	Max. 350 mm/sec
<b>Character Size</b>	0.99 x 2.4 mm / 1.41 x 3.39 mm
<b>Paper Dimension</b>	Width: 79.5 ± 0.5 mm x 83.0 57.5 ± 0.5 x 83.0 mm
<b>Interface</b>	Built-in USB, Built-in Ethernet + Serial, USB Charging Port
<b>Power Consumption</b>	Approx. 27.4 W
<b>Overall Dimension</b>	195 x 145 x 148 mm
<b>Option</b>	Wireless LAN: OT-WL02 [ELPAP10] Customer Display Unit: DM-D30, DM-D110 External Buzzer: OT-BZ20

# TM PRINTER

## Receipt Printers

TM PRINTER

### TM-88VI



Mobility



Print



Power Saving



Auto Cutter



<b>Print Method</b>	Thermal Line Printing
<b>Print Speed</b>	Max. 350 mm/sec
<b>Character Size</b>	0.99 x 2.4 mm / 1.41 x 3.39 mm
<b>Paper Dimension</b>	79.5 ± 0.5 mm x 83.0 / 57.5 ± 0.5 x 83.0 mm
<b>Interface</b>	Built-in USB, Built-in Ethernet + UIB
<b>Power Consumption</b>	Approx. 27.6 W
<b>Overall Dimension</b>	195 x 145 x 148 mm
<b>Option</b>	Wireless LAN: OT-WL02 (ELPAP10) Customer Display Unit: DM-D30, DM-D110 Wall Hanging Unit: WH-10 External Buzzer: OT-BZ20

### TM-U950



Mobility



Print



Power Saving



Auto Cutter



<b>Print Method</b>	9-pin serial impact dot matrix
<b>Print Speed</b>	Approx. 311 / 233 cps
<b>Character Size</b>	1.6 mm x 3.1 mm / 1.3 mm x 3.1 mm
<b>Paper Dimension</b>	69.50 ± 0.50 (W) mm x Ø 83.00 mm
<b>Interface</b>	RS-232, Drawer kick-out, Customer Display, Bidirectional parallel
<b>Power Consumption</b>	Standby: 0.3 A, Mean: 1.8 A
<b>Overall Dimension</b>	251 x 298 x 195 mm
<b>Option</b>	MICR device

# TM PRINTER

## TM-L90



Mobility



Print



Power Saving



Auto Cutter



Technology	Thermal line
Print Resolution	203 x 203 dpi
Type Width	Receipt: Max. 72 mm Label: Max. 70 mm
Max. Print Speed	Max. 150 mm/sec
Interface	Built-in USB + 25-pin serial, with optional parallel and ethernet interface modules
Operating System	Microsoft Windows 8 / 7 / Vista/ XP / POS Ready / Server 2012 / Server 2008 / Server 2003
Power Consumption	Operating: Approx. 1.8 A (mean) Standby: Approx. 0.1 A
Overall Dimension	148 x 140 x 203 mm
Weight	Approx. 1.9 kg

PEELER & LFC MODEL ALSO AVAILABLE

## Receipt & Slip Printer

## TM-H6000V



Mobility



Print



Power Saving



Auto Cutter



Print Method	9-pin serial impact dot matrix
Print Speed	350 mm/sec
Character Size	1.41 mm (W) x 3.39 mm (H) / 0.99 mm (W) x 2.4 mm (H)
Paper Dimension	79.50 ± 0.50 (W) mm x Ø 83.00 mm; 57.50 ± 0.50 (W) mm x Ø 83.00 mm
Interface	RS-232, USB 2.0 Type B, Drawer kick-out, Customer Display
Power Consumption	Approx. 22W
Overall Dimension	186 x 278 x 181 mm
Option	Endorsement printer (E/P), MICR device, Validation

# TM PRINTER

## Slip Printers

### TM-U590

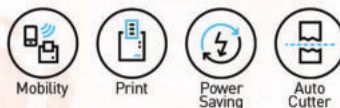

- Print Method** 9-pin serial impact dot matrix
- Print Speed** Approx. 233 / 311 cps
- Character Size** 1.6 mm x 3.1 mm / 1.3 mm x 3.1 mm
- Paper Dimension** Roll Paper (Receipt / Journal): 69.5 ± 0.5 (W) x Ø 83.0 mm; Slip: 70 (W) x 70 mm (L) - 210 (W) x 297 mm (L)
- Interface** RS-232, Drawer kick-out, Customer Display
- Power Consumption** Approx. 1.8 A (mean)  
MCBF: 29,000,000 lines
- Autocutter:** -
- Overall Dimension** 252 x 205 x 185 mm
- Option** USB, Ethernet

### TM-U295

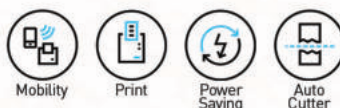

- Print Method** 7-pin, Shuttle Impact Dot Matrix
- Print Speed** Approx. 1.9 - 2.3 lps
- Character Size** 1.6 (W) x 2.9 (H) / 1.3 (W) x 2.9 (H) mm  
Thai Font Size: 1.6 (W) x 8.7 (H) / 1.9(W) x 8.7 (H) mm
- Paper Dimension** 80(W) x 69(L) to 182 (W) x 257 (L) mm
- Interface** RS-232 / Bi-directional Parallel
- Power Consumption** Approx. 600 mA (mean)
- Reliability** MCBF: 7,000,000 lines
- Autocutter:** -
- Overall Dimension** 180 x 290.5 x 101.5 mm



# TM PRINTER

## Airline (Ticketing) Printer

### TM-L500A

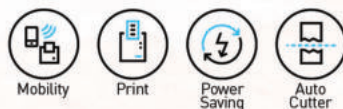

<b>Print Method</b>	Thermal Line Printing
<b>Print Speed</b>	Max 250 mm/sec with optional roll paper holder*1; Boarding Pass: 150 mm/sec (depending on media quality; Baggage Tag: 200 mm/sec (depending on media quality)
<b>Dot Density</b>	16.7 cpi / 12.5 cpi
<b>Paper Dimension</b>	Fanfold paper width: 54.0 ± 0.5 mm, 79.5 ± 0.5 mm, 82.5 ± 0.5 mm Roll paper width & diameter: 54.0 ± 0.5 mm × Ø 184.2 mm, 79.5 ± 0.5 mm × Ø 184.2 mm, 82.5 ± 0.5 mm × Ø 184.2mm
<b>Interface</b>	USB + RS232 (9-Pin Serial), RS232 (25-pin Serial), Ethernet
<b>Power Consumption</b>	Boarding Pass: Approx. 20.3W (at 230V) / Approx. 20.5W (at 115V); Baggage Tag: Approx. 34.4W (at 230V) / Approx. 35.8W (at 115V)
<b>Overall Dimension</b>	236 x 156 x 148 mm
<b>Option</b>	Roll Paper Holder: SU-RPL500 (for roll paper with 76.2 mm inner diameter core), SU-RPL500B (for roll paper with 76.2 mm and 31.75 mm inner diameter core)

## TM Printer Consumable

POSC		
Material Code	Description	Product
C43S015350	ERC-03(B) RIBBON CASSETTE	M-204 / 210V / 210V (C) / 220 Series / 240
C43S015352	ERC-05(B) RIBBON CASSETTE	M-150II
C43S015354	ERC-09(B) RIBBON CASSETTE	M-160/180/190
C43S015356	ERC-09(B) RIBBON CASSETTE	
C43S015358	ERC-18(B) RIBBON CASSETTE	M-2630 Series / 2640 Series / 2660 Series
C43S015360	ERC-22(B) RIBBON CASSETTE	M-180 / 190 / 190G
C43S015366	ERC-27(B) RIBBON CASSETTE	TM-290/U295 M-290
C43S015369	ERC-31(B) RIBBON CASSETTE	TM-H5000II / 5200 / U950 / U925 / U590 / M-930
C43S015371	ERC-32(B) RIBBON CASSETTE	TM-H6000II / U675 / RP-U420 / M-U-420 / 820 Series
C43S015374	ERC-38(B) RIBBON CASSETTE	TM-U220 / U210 / U230 / U325 / U375 / 210AR / U300
C43S015376	ERC-38(B/R) RIBBON CASSETTE	TM-U220 / U210 / U230 / U325 / U375 / 210AR / U300

# LABEL INKJET PRINTER



# LABEL INKJET PRINTER

## MENGAPA MEMILIH LABEL INKJET PRINTER ?

Epson Label Inkjet Printer menghadirkan label warna berkualitas tinggi sesuai kebutuhan untuk meningkatkan efisiensi dan mengurangi biaya pelabelan. Dengan cetakan tinggi kecepatan hingga 103mm per detik, resolusi dan keandalan yang sangat baik, printer ini adalah pilihan yang sempurna untuk industri, kimia, pergudangan, aplikasi pelabelan medis dan lainnya.

### Superior Print Quality

Memastikan hasil cetak gambar yang tajam di setiap label. Epson MicroPiezo® inkjet technology dengan tinta pigmen kami memastikan label yang jernih, teks yang jelas, mudah dibaca, barcode dan grafik yang dinamis yang tahan lama, cepat kering dan tahan luntur. Hasil cetak tahan terhadap noda dan air, bahkan di atas kertas.

Epson pigment ink

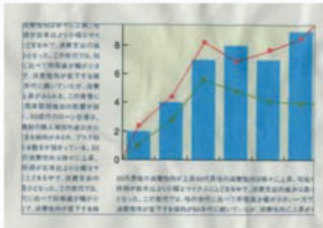

Dye-based ink

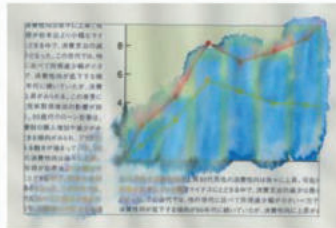

### Berbagai Macam Media

Cetak pada berbagai bahan dan nikmati label warna sesuai kebutuhan. Mulai dari polos, sintetis, matte ke glossy, Printer label Epson memastikan label dengan kualitas cetak superior, memberi Anda gambar yang tajam. Printer label ini juga dapat mencetak pada bahan gulungan, lipatan, die cut atau bahan label bersambung.



Premium matte Ticket



Premium matte label



PE matte label

# STICK WITH QUALITY. STICK WITH COLORWORKS.



**IT'S IN THE DETAILS.**

With PrecisionCore printhead technology, Epson ColorWorks on-demand label printers excel with speed and quality.

# LABEL INKJET PRINTER

## ColourWorks Label Inkjet Printers

### C3510

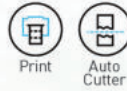

Print Technology	MicroPiezo® Ink Jet Technology
Print Resolution	Up to 720 x 360 dpi
Colour	CMYK
Printing Width	Max. 104 mm (Max. 1,474 dot positions/360dpi)
Printing Speed	Max. 103 mm/sec. (Printing Width: 56 mm, 360 x 360 dpi, Bi-directional Printing)
Interfaces	Hi-Speed USB 2.0 and Ethernet (100BASE-TX /10BASE-T)
Media Type	Plain, matte, synthetic, glossy
External Roll Diameter	Max. 101.6 mm
Power Consumption	Printing: Approx. 30W (mean) Standby: Approx. 2.5W (mean)
Dimensions	283 x 310 x 261 mm
Weight	Approx. 12.0 kg

### CW-C6550P



Print Technology	Serial Inkjet PrecisionCore TFP® with Nozzle Verification Technology
Print Resolution	1200 x 1200 dpi (max.)
Colour	CMYK
Printing Width	Max. 211.9mm (A4 Size)
Printing Speed	Max speed (300x600dpi): 85 mm/sec. Max speed for Glossy media (600x600dpi): 34 mm/sec. *When printing 203.2 mm width
Interfaces	US 2.0 High-Speed, Ethernet 10/100 BASE-T Extended: Dsub-25 pin
Media Type	Matte, synthetic, glossy, high glossy
External Roll Diameter	Max. 152.4 mm
Power Consumption	Printing: Approx. 38.7W Standby: 5.82W
Dimensions	515 x 444 x 326 mm
Weight	Approx. 26.3 kg

# LABEL INKJET PRINTER

## ColourWorks Label Inkjet Printers

### C7510G



Print



Batch  
Printing



High  
Capacity



Auto  
Cutter



**Print Technology** PrecisionCore TFP® with Nozzle Verification Technology

**Print Resolution** 1,200 x 600 dpi  
**Colour** CMYK

**Printing Width** 4.1" (104mm) max.

**Printing Speed** 300 mm/sec.

**Interfaces** USB 2.0 High-Speed, Ethernet 10/100 BASE-T  
Extended: Dsub-15 pin

**Media Type** Plain, matte, synthetic, glossy

**External Roll Diameter** Max. 203.2 mm

**Power Consumption** Printing: Approx. 84W  
Standby: Approx. 5.1W

**Dimensions** 392 x 598 x 395 mm

**Weight** Approx. 37.0 kg

# LABEL INKJET PRINTER

## ColourWorks Label Inkjet Printers

### CW-C6050A



Print Technology	Serial Inkjet PrecisionCore TFP® with Nozzle Verification Technology
Print Resolution	1,200 x 1,200 dpi (Max.)
Colour	CMYK
Printing Width	Max. 108 mm
Printing Speed	Max speed (300x600dpi): 119 mm/sec. Max speed for Glossy media (600x600dpi): 48 mm/sec; *When printing 101.6 mm width
Interfaces	USB 2.0 High-Speed, Ethernet 10/100 BASE-T Extended: Dsub-25 pin
Media Type	Matte, synthetic, glossy, high glossy
External Roll Diameter	Max. 203.2 mm
Power Consumption	Printing: Approx. 39.4W Standby: Approx. 7.51W
Dimensions	565 x 340 x 326 mm
Weight	Approx. 22.5 kg

### CW-C6050P



Print Technology	Serial Inkjet PrecisionCore TFP® with Nozzle Verification Technology
Print Resolution	1,200 x 1,200 dpi (Max.)
Colour	CMYK
Printing Width	Max. 108 mm
Printing Speed	Max speed (300x600dpi): 119mm/sec. Max speed for Glossy media (600x600dpi): 48 mm/sec. *When printing 101.6 mm width
Interfaces	US 2.0 High-Speed, Ethernet 10/100 BASE-T Extended: Dsub-25 pin
Media Type	Matte, synthetic, glossy, high glossy
External Roll Diameter	Max. 203.2 mm
Power Consumption	Printing: Approx. 39.4W Standby: Approx. 7.51W
Dimensions	565 x 340 x 326 mm
Weight	Approx. 22.8 kg

# LABEL INKJET PRINTER

## ColourWorks Label Inkjet Printers

### CW-C6550A



Print



Batch  
Printing



High  
Capacity



Auto  
Cutter



**Print Technology** Serial Inkjet PrecisionCore TFP® with Nozzle Verification Technology

**Print Resolution** 1,200 x 1,200 dpi (max.)

**Colour** CMYK

**Printing Width** Max. 211.9mm (A4 Size)

**Printing Speed** Max speed (300x600dpi): 85 mm/sec. Max speed for Glossy media (600x600dpi): 34 mm/sec. \*When printing 203.2 mm width

**Interfaces** US 2.0 High-Speed, Ethernet 10/100 BASE-T Extended: Dsub-25 pin

**Media Type** Matte, synthetic, glossy, high glossy

**External Roll Diameter** Max. 152.4 mm

**Power Consumption** Printing: Approx. 38.7W  
Standby: 5.82W

**Dimensions** 515 x 444 x 326 mm

**Weight** Approx. 25.5 kg



# LABEL INKJET PRINTER

## ColorWorks Labeljet Printer Consumable

Material Code	Description	Compatibility
<b>ColorWorks Label InkJet Printer Consumable</b>		
C33S020464	SJIC15P-464	TM-C3400
C33S020490	SJIC20P(K)-490: Ink Cartridge for TM-C3400BK	TM-C3400 BK
C33S020580	SJMB3500: Maintenance Box	TM-C3510
C33S020578	SJIC23P(K): Ink Cartridge for TM-C3510	
C33S020584	SJIC23P(C): Ink Cartridge for TM-C3510	
C33S020585	SJIC23P(M): Ink Cartridge for TM-C3510	
C33S020586	SJIC23P(Y): Ink Cartridge for TM-C3510	
C13S020559	GJIC4(K) Ink BK for Liatris-II	GP-C 830 / GP-M 830
C13S020560	GJIC4(C) Ink C for Liatris-II	GP-C 830
C13S020561	GJIC4(M) Ink M for Liatris-II	
C13S020562	GJIC4(Y) Ink Y for Liatris-II	
C33S020464	SJIC15P: 3-Colour for TM-C3400, Pigment Ink	TM-C3400
C33S020643	SJIC31P(K): Ink Cartridge	TM-C7510G
C33S020644	SJIC31P(C): Ink Cartridge	
C33S020645	SJIC31P(M): Ink Cartridge	
C33S020646	SJIC31P(Y): Ink Cartridge	
C33S020596	SJMB7500:MAINTENANCE BOX (C7500 Series)	
C13T44G100	SJIC40P-K: Ink Cartridge 70ml	CW-C6050/C6550
C13T44G200	SJIC40P-C: Ink Cartridge 70ml	
C13T44G300	SJIC40P-M: Ink Cartridge 70ml	
C13T44G400	SJIC40P-Y: Ink Cartridge 70ml	
C33S021501	SJMB6000: MAINT. BOX FOR CW-C6050/C6550	CW-C6050/C6550

# LABEL PRINTER



# LABEL PRINTER

## MENGAPA MEMILIH EPSON LABEL PRINTER ?

Dari organisasi rumah dan kantor yang sederhana hingga penandaan sistematis aset untuk sekolah, pabrik, rumah sakit, dan lainnya, Printer Epson LabelWorks menawarkan solusi profesional yang mudah digunakan untuk setiap kebutuhan pelabelan. Berbagai pilihan media label Epson mulai dari ukuran lebar, pola, warna dan gaya untuk membuat kualitas tinggi, label profesional dengan limbah minimal dan penghematan yang maksimum.



Weather Resistant



Abrasion Resistant



Temperature Resistant



Water Resistant



Chemical Resistant

## Penghematan biaya

Semua printer LabelWorks dirancang untuk efisiensi biaya yang lebih besar. Melalui penggunaan sisi signifikan margin yang lebih kecil, sehingga pemborosan berkurang. Dengan panjang pita lebih panjang yang ditawarkan Epson, hemat lebih banyak biaya operasional pencetakan.

### Lead margins

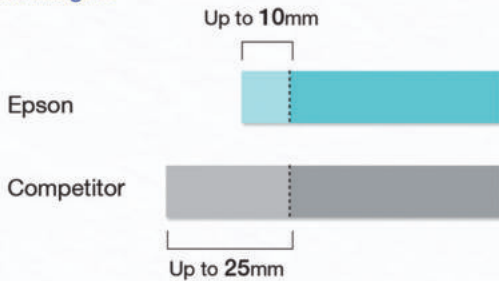

### Tape savings

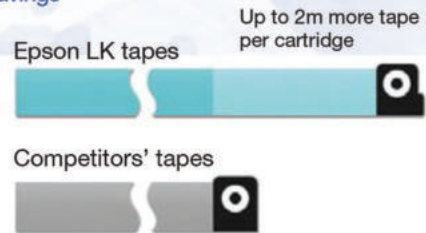



HOME

OFFICE

INDUSTRIAL

# COMPREHENSIVE LABELLING SOLUTION FOR ADDED CREATIVITY & CONVENIENCE.

LabelWork Printer

IT'S IN THE DETAILS.

# LABEL PRINTER

Compact and Efficient Helper



## LW-K400



Low Cost  
Per Print



Temperature  
Resistant  
Labels

Technology	Thermal Transfer
Print Resolution	180 dpi / 64 dot
Print Speed	Up to 6 mm/sec
Type Width	6, 9, 12, 18 mm
Display Size	130 x 48 dot
Keyboard Type	QWERTY / 61
Power Consumption	Battery 6 pcs AA (optional)
Overall Dimension	110 x 170 x 56 mm
Weight	0.41 kg

---

## LW-700



Auto  
Cutter



Low Cost  
Per Print



Temperature  
Resistant  
Labels



Technology	Thermal Transfer
Print Resolution	180 dpi / 128 dot
Print Speed	Up to 25 mm/sec
Type Width	6, 9, 12, 18, 24 mm
Display Size	128 x 64 dot
Keyboard Type	QWERTY / 61
Operating System	Win7, Vista, XP (32/64 Bit), Mac OS
Overall Dimension	235 x 180 x 80 mm
Weight	0.77 kg

# LABEL PRINTER

## Professional Labelling



### LW-C410



Auto  
Cutter



Low Cost  
Per Print



Temperature  
Resistant  
Labels

Technology	Thermal Transfer
Print Resolution	180 dpi / 96 dots
Tape Width	6, 9, 12, 18 mm
Max. Print Speed	9 mm / sec
Cartridge Type	LK Tape Cartridge
Max. Print Width	13.5 mm
Interface	Bluetooth
Batteries	6 pcs AA
Dimension	54 x 134 x 145 mm
Weight	0.41 kg

### LW-600P



Auto  
Cutter



Low Cost  
Per Print



Temperature  
Resistant  
Labels



Technology	Thermal Transfer
Print Resolution	180 dpi / 128 dot
Tape Width	6, 9, 12, 18, 24 mm
Display Size	N/A
Keyboard Type	Dependent on user's PC
Operating System	Windows, Mac OS, Android & iOS
Power Consumption	Battery 6 pcs AA
Overall Dimension	55 x 132 x 146 mm
Weight	0.44 kg

# LABEL PRINTER



## LW-Z900FK



Auto  
Cutter



Low Cost  
Per Print



Temperature  
Resistant  
Labels

Technology	Thermal Transfer
Print Resolution	360 dpi / 384 dot
Print Speed	Up to 35 mm/sec
Type Width	6 - 36 mm
Display Size	N/A
Keyboard Type	QWERTY
Operating System	Windows XP, Vista, 7 - 10, MAC - OS
Power Consumption	Li-ion Battery (bundled) / 6AA (optional)
Overall Dimension	136 x 295 x 97 mm
Weight	1.25 kg

## LW-Z700FK



Auto  
Cutter



Low Cost  
Per Print



Temperature  
Resistant  
Labels



Technology	Thermal Transfer
Print Resolution	180 dpi / 128 dot
Print Speed	Up to 30 mm/sec
Type Width	6 - 24 mm
Keyboard Size	QWERTY
Max. Print Speed	Up to 30 mm/sec
Operating System	Windows XP, Vista, 7, 8, 9, 10
Power Consumption	Li-ion Battery (Bundled) / 6AA (Optional)
Overall Dimension	136 x 298 x 90 mm
Weight	1.11 kg

## LW-1000P



Auto  
Cutter



Low Cost  
Per Print



Temperature  
Resistant  
Labels



Technology	Thermal Transfer & Direct Thermal
Print Resolution	360 dpi / 384 dot
Type Width	6, 9, 12, 18, 24, 36 mm
Display Size	N/A
Keyboard Type	Dependent on user's PC
Operating System	Win7, Vista, XP (32/64 Bit), Mac OS
Interface	USB, Wi-Fi, LAN
Power Consumption	AC adapter
Overall Dimension	123 x 153 x 139 mm
Weight	1.08 kg

# LABEL PRINTER

Professional Labelling

LABEL PRINTER

## LW-Z5000WA



Technology	Thermal Transfer
Print Resolution	180 dpi / 128 dot
Print Speed	Up to 30 mm/sec
Label Width	12 - 50 mm
Max. Print Speed	Up to 30 mm/sec
Operating System	Windows XP, Vista, 7, 8, 9, 10
Power Consumption	AC adapter
Overall Dimension	136 x 298 x 90 mm
Weight	1.11 kg

## LW-Z5010BA



Technology	Thermal Transfer & Direct Thermal
Print Resolution	360 dpi / 384 dot
Label Width	12 - 50 mm
Display Size	4.3 inch
Keyboard Type	Dependent on user's PC
Operating System	Win7, Vista, XP (32/64 Bit), Mac OS
Interface	USB, Wi-Fi, LAN
Power Consumption	AC adapter/Battery Li-ion
Overall Dimension	123 x 153 x 139 mm
Weight	1.08 kg



# LABEL PRINTER

## Label Printer Consumable

Remarks	Material Code	Description	Remarks	Material Code	Description
Compatible for Epson LabelWorks			Compatible for Epson LabelWorks		
Heat Shrink Tube	C53S654903	LK-4WBA3 - Black On White HT Shrink dia. 3mm	Consumable	C13S090009	Clean Stick A
	C53S654905	LK-4YBA3 - Black On Yellow HT Shrink dia. 3mm		C13S090011	Clean Stick B
	C53S654904	LK-4WBA5 - Black On White HT Shrink dia. 5mm		C13T639000	L-4033A Overprint Ink Cartridge (700ml)
	C53S654906	LK-4YBA5 - Black On Yellow HT Shrink dia.5mm		C13T639100	L-4033A Photo Black Ink Cartridge (700ml)
	C53S656902	LK-6WBA11 - Black On White HT Shrink dia. 11mm		C13T639200	L-4033A Cyan Ink Cartridge (700ml)
	C53S656904	LK-6YBA11 - Black On Yellow HT Shrink dia. 11mm		C13T639300	L-4033A Magenta Ink Cartridge (700ml)
	C53S656903	LK-6WBA14 - Black On White HT Shrink dia. 14mm		C13T639400	L-4033A Yellow Ink Cartridge (700ml)
	C53S656905	LK-6YBA14 - Black On Yellow HT Shrink dia. 14mm		C13T639500	L-4033A Mate Black Ink Cartridge (700ml)
	C53S657903	LK-7WBA21 - Black On White HT Shrink dia. 21mm		C13T639600	L-4033A Orange Ink Cartridge (700ml)
	C53S657904	LK-7YBA21 - Black On Yellow HT Shrink dia. 21mm		C13T639700	L-4033A Green Ink Cartridge (700ml)
Die-Cut	C53S658901	LK-8WBWAA - Die-Cut (Circle)	C13T639800	L-4033A Moisture Liquid Cartridge (350ml)	
	C53S658902	LK-8WBWAB - Die-Cut (Oval)	C13T639A00	Uncoated Black Cartridge for L-4033A	
	C53S658903	LK-8WBWAC - Die-Cut (Rectangle)	C13T639B00	White Cartridge for L-4033A	
6mm	C53S652501	LK-2WBN - 6mm Black On White Tape	C13T639C00	Storage liquid for L-4033A	
9mm	C53S653501	LK-3WBN - 9mm Black On White Tape	C13T639D00	Moisture Liquid (700ml) for L-4033A	
	C53S653504	LK-3GBP - 9mm Black On Green	C13S400063	Swab Head A	
12mm	C53S653506	LK-3YBP - 9mm Black On Yellow	Consumable	C13S090009	Clean Stick A
	C53S654501	LK-4WBN - 12mm Black On White Tape		C13S090011	Clean Stick B
	C53S654502	LK-4WRN - 12mm Red On White Tape		C13S210062	Cloth for Web Cleaner
	C53S654503	LK-4WLN - 12mm Blue On White Tape		C13T799100	L-6034 Black Ink Cartridge (3L)
	C53S654505	LK-4BWV - 12mm White On White Tape		C13T799200	L-6034 Cyan Ink Cartridge (3L)
	C53S654506	LK-4SBM - 12mm Black On Silver Tape		C13T799300	L-6034 Magenta Ink Cartridge (3L)
	C53S654507	LK-4KBM - 12mm Black On Gold Tape		C13T799400	L-6034 Yellow Ink Cartridge (3L)
	C53S654508	LK-4WBQ - 12mm Black On White Iron-On		C13T799500	L-6034 D Varnish Ink Cartridge (3L)
	C53S654509	LK-4PBQ - 12mm Black On Pink Iron-On		C13T799600	L-6034 White Ink Cartridge (2.6L)
	C53S654510	LK-4KBK - 12mm Black On Gold (Ribbon)		C13T799800	L-6034 Storage Liquid (2.6L)
	C53S654511	LK-4PBK - 12mm Black On Pink (Ribbon)		7112440	Washing liquid - EDGAC (20 Liter)
	C53S654512	LK-4EAY - 12mm Gray On Polkadot Pink Tape			
	C53S654513	LK-4CAY - 12mm Gray On Blue Check Tape			
	C53S654514	LK-4TBN - 12mm Black On Transparent Tape			
	C53S654515	LK-4YBP - 12mm Black On Yellow Tape			
	C53S654518	LK-4LBP - 12mm Black On Blue			
	18mm	C53S655501		LK-5WBN - 18mm Black On White Tape	
C53S655502		LK-5WRN - 18mm Red On White Tape			
C53S655506		LK-5SBM - 18mm Black On Silver Tape			
C53S655507		LK-5KBM - 18mm Black On Gold Tape			
C53S655512		LK-5TBN - 18mm Black On Transparent Tape			
24mm	C53S655513	LK-5ZBU - 18mm Black On Glow-In-Dark Tape			
	C53S655514	LK-5YBP - 18mm Black On Yellow Tape			
	C53S655519	LK-5GBP - 18mm Black On Green			
	C53S656501	LK-6WBN - 24mm Black On White Tape			
36mm	C53S656503	LK-6BWV - 24mm White On Black Tape			
	C53S656507	LK-6YBP - 24mm Black On Yellow Tape			
	C53S656901	LK-6WBC - 24mm Black on 1/3 White 2/3 Color Tape			
36mm	C53S657501	LK-7WBN - 36mm Black On White Tape			
	C53S657503	LK-7RBP - 36mm Black On Red Tape			
	C53S657504	LK-7YBP - 36mm Black On Yellow Tape			
	C53S657506	LK-7LWV - 36mm White On Blue Tape			
	C53S657507	LK-7TBN - 36mm Black On Transparent			
	C53S657508	LK-7GBP - 36mm Black On Green			
	C53S657902	LK-7WBC - 36mm Black on 1/3 White 2/3 Color Tape			

# DISC PUBLISHER



# DISC PUBLISHER

## DISC PUBLISHER

DISCPRODUCER™ PP-50II/PP-100III/PP-100N

Discproducer combines Epson's market leading expertise in advanced inkjet printing and precision robotics to offer an efficient and highly reliable integrated disc publishing solution for a wide range of industries and applications. With Discproducer, fully automated Blu-Ray, DVD and CD publishing is just a push of a button away.

### Unrivalled Performance with Cost Savings

Epson's industry-leading Micro Piezo print head and ink technology ensure uniform, stable ink droplets with virtually no satellites or misting, producing brilliant and crisp disc labels at a high resolution of up to 1440 dpi x 720 dpi.

Epson's Micro Piezo™ technology also protects against striation and ink bleed, and allows ultra-fine colour graduation plus razor-sharp text – even in small font sizes.

Instead of using the traditional whole cartridges, Discproducer utilises six individual high-capacity ink cartridges that can be easily replaced quickly, thus allowing you to print more while keeping running costs low.



### Convenient Total Front-Operation

Discproducer is the only system in its class that offers the ergonomic advantages of total front-operation and status reporting.

Unlike other systems that allow publishing to continue without ink, Discproducer shows ink level status using an LED for each individual colour. This allows the printing process to be manually or automatically interrupted in case of a near-empty ink cartridge, thereby eliminating damage and waste.



### High Precision and Reliability

Discproducer is built to withstand hard knocks and keep dust out. The solid body provides a sturdy housing for the intricate technologies within to run processes smoothly without any interruption.



Misfed and damaged discs are a thing of the past, thanks to the patented AcuGrip robotic arm which handles one disc at a time reliably. This reduces the risk of incurring scratches on the disc, often caused by conventional sliding mechanisms and prevents interruptions during unsupervised production, caused by mechanical blockage.

AcuGrip™



# DISC PUBLISHER

## Disc Producer Series

### PP-100III



- Publishing Speed** CD: 30 discs/hour  
DVD: 15 discs/hour
- Printing Only** CD: 60 discs/hour, bidirectional (fast mode)  
DVD: 40 discs/hour, bidirectional (fine mode)
- Print specifications** Serial Serial inkJet Dot-Matrix, Six-color (Dye ink: C, LC, M, LM, Y, Bk) / 1,440 dpi x 720 dpi (fast mode) / 1,440 dpi x 1,440 dpi (fine mode) / 720 dpi x 720 dpi (PP-100AP Level3)
- CD/DVD Drives** 2 drives
- Supported Media** CD-R, DVD-R, DVD+R, DVD-R DL
- Interface** Hi-Speed USB
- Overall Dimensions** 377 (W) x 465 (D) x 348 (H) mm
- Mass** Approx. 24.0 kg
- Software** EPSON Total Disc Maker: Installed to the user's PC to publish discs/PP-100; EPSON Total Disc Monitor: Displays the status of jobs and devices; EPSON Printer driver for PP-100 Series; EPSON Total Disc Net Administrator: The web application for product setting, user management, job history management & authorization workflow (PP-100N only); TD Bridge: System incorporation tool to use the PP-100, PP-100N, PP-50 with other companies' applications. (Included CD does not have this software).

### PP-100N



- Publishing Speed** CD: 30 discs/hour  
DVD: 15 discs/hour
- Printing Only** CD: 60 discs/hour, bidirectional (fast mode)  
DVD: 40 discs/hour, bidirectional (fine mode)
- Print specifications** Serial Serial inkJet Dot-Matrix, Six-color (Dye ink: C, LC, M, LM, Y, Bk) / 1,440 dpi x 720 dpi (fast mode) / 1,440 dpi x 1,440 dpi (fine mode) / 720 dpi x 720 dpi (PP-100AP Level3)
- CD/DVD Drives** 2 drives
- Supported Media** CD-R, DVD-R, DVD+R, DVD-R DL
- Interface** Ethernet
- Overall Dimensions** 377 (W) x 514 (D) x 348 (H) mm
- Mass** Approx. 25.0 kg
- Software** EPSON Total Disc Maker: Installed to the user's PC to publish discs/PP-100; EPSON Total Disc Monitor: Displays the status of jobs and devices; EPSON Printer driver for PP-100 Series; EPSON Total Disc Net Administrator: The web application for product setting, user management, job history management & authorization workflow (PP-100N only); TD Bridge: System incorporation tool to use the PP-100, PP-100N, PP-50 with other companies' applications. (Included CD does not have this software).

# DISC PUBLISHER

## PP-50II



Cost Effective



Fastest Total Throughput



Quiet Operation



### Publishing Speed

CD: 15 discs/hour

DVD: 8 discs/hour

### Printing Only

CD: 60 discs/hour, bidirectional (fast mode)

DVD: 40 discs/hour, bidirectional (fine mode)

### Print specifications

Serial InkJet Dot-Matrix, Six-color (Dye ink: C, LC, M, LM, Y, Bk) / 1,440 dpi x 720 dpi (fast mode) / 1,440 dpi x 1,440 dpi (fine mode) / 720 dpi x 720 dpi (PP-100AP Level3)

1 drives

### CD/DVD Drives Supported Media

CD-R, DVD-R, DVD+R, DVD-R DL, DVD+R DL

Stackers 1, 2: 50 discs (Publishes up to 50 discs in a single job)

### Stacker Capacity Interface

Stackers 3: 20 discs

Hi-Speed USB

### Power Consumption

Approx. 40 W (mean)

### Overall Dimensions

377 (W) x 465 (D) x 324 (H) mm

### Mass

Approx. 21.0 kg

### Reliability

Product life: 15,000 discs or 5 years CD/DVD drive:

15,000 times (number of writing), 1,000 hours (writing time)

### Software

EPSON Total Disc Maker: Installed to the user's PC to publish discs/PP-100; EPSON Total Disc Monitor: Displays the status of jobs and devices; EPSON Printer driver for PP-100 Series; EPSON Total Disc Net Administrator: The web application for product setting, user management, job history management & authorization workflow (PP-100N only); TD Bridge: System incorporation tool to use the PP-100, PP-100N, PP-50 with other companies' applications. (Included CD does not have this software).

[www.epson.co.id/dotmatrix](http://www.epson.co.id/dotmatrix)

# DOT MATRIX PRINTER



**QUALITY  
& VALUE**  
GENUINE SUPPLIES



# DOT MATRIX PRINTER

## MENGAPA MEMILIH PRINTER DOT MATRIX EPSON?

Printer Epson dot matrix adalah partner ideal Anda untuk pencetakan tugas berat dengan biaya rendah melalui kemampuannya untuk bekerja dengan Multi-part. Printer ini hanya membutuhkan penggantian pita sesekali karena pita tinta yang digunakan tetap berfungsi bahkan setelah penyimpanan lama, berfungsi sebagai pekerja keras yang ideal untuk bisnis Anda.

ESC / P yang dikembangkan Epson adalah kontrol untuk printer dot matrix standar dunia. Ini berarti terlepas dari platform, perangkat lunak atau jaringan yang Anda gunakan, sehingga dapat langsung menyambungkan dan menjalankan printer Anda.



### Quality and Value

Pita asli Epson memastikan hasil lebih besar, kualitas lebih baik, dan umur lebih panjang



### Maximise Productivity

Cetak di atas kertas bersambung dan kertas belapis untuk membuat salinan karbon yang memenuhi kebutuhan spesifik bisnis Anda



### Cost-efficient

Nikmati biaya kepemilikan yang rendah dengan biaya cetak yang kompetitif per halaman melalui pita tinta yang ekonomis.



### Superior Reliability

dirancang untuk bertahan dengan kualitas yang kuat dan kinerja yang konsisten.



### Hassle-free

Tengan pita tinta yang tahan lama dan waktu rata-rata yang tinggi di antara kegagalan (MTBF), Anda akan mendapatkan waktu henti yang minimal.

# DOT MATRIX PRINTER

## SIDM 9-Pin Printers



### LX-310



Print



Cost Effective



High Speed Printing

Print Method	Impact dot matrix
Number Of Pins	9 pins
Print Speed	High speed: 347 / 357 / 390 cps Draft: 260 / 312 / 223 cps NLQ: 65 / 78 / 55 / 47 / 56 cps
Reliability	Printhead life: Approx. 400 million strokes/wire MVBF: Approx. 20 million lines (Except print head) MTBF: Approx. 10,000 POH (25% Duty)
Ribbon Life	Approx. 4.0 million characters
Operating System	Microsoft® Windows® 2000 / XP / Vista / 7 / 8 / 8.1 / 10
Memory Buffer	128 KB
Interface	Bi-directional parallel (IEEE-1284 nibble mode supported), USB 2.0 Full-Speed, Serial
Power Consumption	Approx. 27W
Dimension	362 x 275 x 154 mm
Weight	Approx. 4.1 kg



### FX-2190II



Print



Cost Effective



High Speed Printing

Print Method	Impact dot matrix
Number Of Pins	9 pins
Print Speed	Ultra speed: 615 / 738 cps High speed: 612 / 694 cps Draft: 463 / 555 cps
Reliability	Printhead life: 400 million strokes/wire MVBF: 52 million lines (except print head) MTBF: 25,000 Power On Hours (POH) (25% Duty)
Ribbon Life	Approx. 12 million characters
Operating System	Microsoft Windows XP / Vista / 7 / 8 / 10
Memory Buffer	128 KB
Interface	USB 2.0, Bi-directional parallel (IEEE-1284 nibble mode supported)
Power Consumption	Approx. 54W
Dimension	612 x 375 x 176.5 mm
Weight	Approx. 9.4 kg



# DOT MATRIX PRINTER

## SIDM 9-Pin Printers

### FX-2190IIN



Print



Cost Effective



High Speed Printing



Print Method	Impact dot matrix
Number Of Pins	9 pins
Print Speed	Ultra speed: 615 / 738 cps High speed: 612 / 694 cps Draft: 463 / 555 cps
Reliability	Printhead life: 400 million strokes/wire MVBF: 52 million lines (except print head) MTBF: 25,000 Power On Hours (POH) (25% Duty)
Ribbon Life	Approx. 12 million characters
Operating System	Microsoft Windows XP / Vista / 7 / 8 / 10
Memory Buffer	128 KB
Interface	USB 2.0, Bi-directional parallel (IEEE-1284 nibble mode supported) Serial, 100base-TX wired LAN
Power Consumption	Approx. 54W
Dimension	612 x 375 x 176.5 mm
Weight	Approx. 9.4 kg

### DFX-9000



Print



Cost Effective



High Speed Printing



Print Method	Impact dot matrix
Number Of Pins	36 pins
Print Speed	High speed: 1,550 / 1,450 cps Draft: 1,320 x 1,320 cps NLQ: 330 / 330 cps
Reliability	Printhead life: 200 million strokes/wire MVBF: 133 million lines (except print head) MTBF: 20,000 POH (25% duty cycle)
Ribbon Life	15 million characters
Operating System	Microsoft Windows® Me / XP / Vista® / Windows 7 / 8 / 8.1 / 10 (32/64bit)
Memory Buffer	128 KB
Interface	Bi-directional parallel interface (IEEE-1284 nibble mode supported), Serial I/F, USB 2.0 (Full Speed) I/F
Power Consumption	Approx. 185W
Dimension	700 x 378 x 363 mm
Weight	Approx. 34 kg

# DOT MATRIX PRINTER

## SIDM 24-Pin Printers



### LQ-310



Print



Cost Effective



High Speed Printing

Print Method	Impact dot matrix
Number Of Pins	24 pins
Print Speed	High speed: 347 / 416 cps Draft: 260 / 312 / 390 cps NLQ: 86 / 103 / 129 cps
Reliability	Printhead life: Approx. 400 million strokes/wire MVBF: Approx. 20 million lines (except print head) MTBF: Approx. 10,000 POH (25% Duty)
Ribbon Life	Approx. 2.5 million characters
Operating System	Windows 95 / 98 / 2000 / Me / XP / Vista / 7 / 8 / 8.1 / 10
Memory Buffer	128 KB
Interface	Bi-directional parallel interface (IEEE-1284 nibble mode supported), USB 2.0 Full-Speed, Serial
Power Consumption	Approx. 24W
Dimension	362 x 275 x 154 mm
Weight	Approx. 4.1 kg



### LQ-590II



Print



Cost Effective



High Speed Printing

Print Method	Impact dot matrix
Number Of Pins	24 pins
Print Speed	Ultra high speed: 550 cps High speed: 487 / 584 cps Draft: 366 / 439 cps
Reliability	Printhead life: 400 million strokes / wire MVBF: 50 million lines (except print head) MTBF: 25,000 Power On Hours (POH) (25% Duty)
Ribbon Life	Approx. 5 million characters
Operating System	Microsoft Windows XP / Vista / 7 / 8 / 10
Memory Buffer	128 KB
Interface	USB 2.0, Bi-directional parallel, (IEEE-1284 nibble mode supported)
Power Consumption	Approx. 49W
Dimension	414 x 320 x 176.5 mm
Weight	Approx. 7.2 kg

# DOT MATRIX PRINTER

## SIDM 24-Pin Printers

### LQ-590IIN



Print



Cost Effective



High Speed Printing



Print Method	Impact dot matrix
Number Of Pins	24 pins
Print Speed	Ultra high speed: 550 cps High speed: 487 / 584 cps Draft: 366 / 439 cps
Reliability	Printhead life: 400 million strokes / wire MVBF: 50 million lines (except print head) MTBF: 25,000 Power On Hours (POH) (25% Duty)
Ribbon Life	Approx. 5 million characters
Operating System	Microsoft Windows XP / Vista / 7 / 8 / 10
Memory Buffer Interface	128 KB USB 2.0, Bi-directional parallel (IEEE-1284 nibble mode supported), Serial, 100base-Tx wired LAN
Power Consumption	Approx. 49W
Dimension	414 x 320 x 176.5 mm
Weight	Approx. 7.2 kg

### LQ-2090II



Print



Cost Effective



High Speed Printing



Print Method	Impact dot matrix
Number Of Pins	24 pins
Print Speed	Ultra speed: 550 cps High speed: 487 / 584 cps Draft: 366 / 439 cps
Reliability	Printhead life: 400 million stroke/wire MVBF: 50 million lines (except print head) MTBF: 25,000 Power On Hours (POH) (25% Duty)
Ribbon Life	Approx. 8 million characters
Operating System	Microsoft Windows XP / Vista / 7 / 8 / 10
Memory Buffer Interface	128 KB USB 2.0, Bi-directional parallel (IEEE-1284 nibble mode supported)
Power Consumption	Approx. 49W
Dimension	612 x 375 x 176.5 mm
Weight	Approx. 9.4 kg

# DOT MATRIX PRINTER

## SIDM 24-Pin Printers



### LQ-780



Print



Cost Effective



High Speed Printing

Print Method	Impact dot matrix
Number Of Pins	24 pins
Print Speed	High speed: 487 / 584 cps Draft: 366 / 439 / 549 cps LQ: 121 / 145 / 181 cps
Reliability	Printhead life: 400 million strokes/wire MVBF: 40 million lines (Except print head) MTBF: 20,000Hrs POH (25% duty cycle)
Ribbon Life	Approx. 10 million characters
Operating System	Microsoft Windows XP / Vista / 7 / 8 / 8.1 / 10 / 11
Memory Buffer Interface	128 KB Bi-directional Parallel (IEEE 1284 Nibble mode support), USB 2.0 (Full Speed Mode)
Power Consumption	Approx. 46W
Dimension	480 x 301.3 x 211 mm
Weight	Approx. 6.7 kg



### LQ-780N



Print



Cost Effective



High Speed Printing

Print Method	Impact dot matrix
Number Of Pins	24 pins
Print Speed	High speed: 487 / 584 cps Draft: 366 / 439 / 549 cps LQ: 121 / 145 / 181 cps
Reliability	Printhead life: 400 million strokes/wire MVBF: 40 million lines (Except print head) MTBF: 20,000Hrs POH (25% duty cycle)
Ribbon Life	Approx. 10 million characters
Operating System	Microsoft Windows XP / Vista / 7 / 8 / 8.1 / 10 / 11
Memory Buffer Interface	128 KB Bi-directional Parallel (IEEE 1284 Nibble mode support), USB 2.0 (Full Speed Mode), LAN (for N models only)
Power Consumption	Approx. 46W
Dimension	480 x 301.3 x 211 mm
Weight	Approx. 6.7 kg

# DOT MATRIX PRINTER

## SIDM 24-Pin Printers

### LQ-2090IIN



<b>Print Method</b>	Impact dot matrix
<b>Number Of Pins</b>	24 pins
<b>Print Speed</b>	Ultra high speed: 550 cps High speed: 487 / 584 cps Draft: 366 / 439 cps
<b>Reliability</b>	Printhead life: 400 million strokes / wire MVBF: 50 million lines (except print head) MTBF: 25,000 Power On Hours (POH) [25% Duty]
<b>Ribbon Life Operating System</b>	Approx. 8 million characters Microsoft Windows XP / Vista / 7 / 8 / 10
<b>Memory Buffer Interface</b>	128 KB USB 2.0, Bi-directional parallel [IEEE-1284 nibble mode supported], Serial, 100base-Tx wired LAN
<b>Power Consumption</b>	Operating Approx. 49W/Sleep Mode Approx. 0.8W
<b>Dimension Weight</b>	612 x 375 x 176.5mm 9.4kg

### LQ-2190



<b>Print Method</b>	Impact dot matrix
<b>Number Of Pins</b>	24 pins
<b>Print Speed</b>	High speed: 480 / 576 cps Draft: 360 / 432 / 540 cps NLQ: 120 / 144 / 180 cps
<b>Reliability</b>	Printhead life: Approx. 400 million strokes/wire MVBF: Approx. 40 million lines (except print head) MTBF: 20,000 Power On Hours (POH) [25% Duty]
<b>Ribbon Life Operating System</b>	Approx. 15 million characters Microsoft® Windows® 2000 / XP / Vista / 7 / 8 / 8.1 / 10
<b>Memory Buffer Interface</b>	128 KB Bi-directional Parallel Interface [IEEE-1284 nibble mode supported], USB 2.0 [Full Speed], Type B I/F Level 2 [Option]
<b>Power Consumption</b>	Approx. 46W
<b>Dimension Weight</b>	639 x 402 x 256 mm Approx. 13 kg

# DOT MATRIX PRINTER

## SIDM 48-Pin Printers

### DLQ-3500IIN STD



Print



Cost Effective



High Speed Printing



Print Method	Impact dot matrix
Number Of Pins	24 pins x 2 (total 48 pins)
Print Speed	High speed: 550 cps Draft: 550 cps LQ: 195 cps
Reliability	MVBF: 25 million lines MTBF: 10,000 Power On Hours (POH) Printhead life: 200 million strokes / wire
Ribbon Life	Approx. 6 million characters
Operating System	Microsoft Windows® XP / Vista / 7 / 8 / 10
Memory Buffer	128 KB
Interface	USB 2.0, Bi-directional parallel (IEEE-1284 nibble mode supported), 100base-Tx wired LAN
Power Consumption	Approx. 78 W
Dimension	661 x 433 x 276 mm
Weight	18.9 kg

# RELIABLE, SEAMLESS INTEGRATION MAKES ALL THE DIFFERENCE.



At Epson, we focus on the details. Epson passbook printers are a definite sleek and sound investment for your organisation. Based on Epson's experience in delivering industry-standard solutions, these printers help you run and grow your business and stay in control of your operations. With the flexible and versatile PLQ-35/50 series passbook printers, you can increase service productivity and operational efficiency while maintaining a low total cost of ownership.



Print



High Speed  
Printing



Colour LED  
Control Panel



Cost Effective



Power  
Savings

#### 1.44" Colour LED Control Panel

With the new feature of 1.44" colour LED control panel\* for easy settings, configuration and checking printer status without wasting paper.

#### Fast Print Speed

Maximise productivity with faster printing speed of up to 630 cps (10 cpi).

#### Enhanced Reliability

Better reliability with printhead life up to 600 millions strokes/wire (in characters) and mean-time-between failure (MTBF) of up to 35,000 POH (power on hours).

# DOT MATRIX PRINTER

## Passbook Printers



### PLQ-35



- Print Method** 24 pins Impact Dot Matrix
- Printer Speed** PR2 Emulation (10 cpi): 540 Ultra High Speed Draft/ 480 High Speed Draft/ 360 Draft/ 180 NLQ/ 120 LQ  
ESC/P2, Others (10 cpi): 540 Ultra High Speed Draft/ 480 High Speed Draft/ 360 Draft/ 120 LQ  
IBM 4722 (10 cpi): 360 Standard Text/ 240 NLQ
- Interface** Bi-directional parallel interface (IEEE-1284 nibble mode supported), Serial I/F, High Speed USB 2.0
- Power Consumption** 61W Operation/ 0.7 W Sleep Mode
- Dimensions** 384 x 280 x 203 mm
- Weight** 7.8 kg



### PLQ-50



- Print Method** Impact dot matrix
- Number Of Pins** 24 pins
- Print Speed** Ultra high speed: 630 cps  
High speed: 560 cps  
Draft: 420 cps
- Reliability** Printhead life: 600 million strokes/wire  
MVBF: 24 million lines  
MTBF: 35000 POH
- Ribbon Life** Approx. 5 million characters
- Operating System** Microsoft Windows XP, Vista, 7, 8, 8.1, 10. Windows Server 2003, 2008, 2012, 2016
- Interface** Bi-directional parallel interface (IEEE-1284 nibble mode supported), Serial I/F, High Speed USB 2.0
- Power Consumption** Approx. 77W
- Dimension** 384 x 280 x 203 mm
- Weight** Approx. 7.9 kg



# DOT MATRIX PRINTER

## Dot Matrix Consumable

Product Code	Ribbon Cartridges	Main Unit	Ribbon Specifications
C13S015516	Ribbon, #8750(B), Asia	LX-300 / 300+ / 300+II	3 mil character / 17.7m, 58 ft x 13mm, 0.5"
C13S015506	Ribbon, #7753(B), Asia	LQ-300 / 300+II / 580 / LQ-200	2 mil character / 10m, 32.8 ft x 13mm, 0.5"
C13S015632	Ribbon Cartridge ( S015632)	LX-310	4 mil character / 18.0m, 59 ft x 13mm, 0.5"
C13S015639	Ribbon Cartridge ( S015634)	LQ-310	2.5 mil character / 10m, 32.8 ft x 13mm, 0.5"
C13S015531	Ribbon, S015086(B), Asia	LQ-2070 / 2180 / 2080 / 2190 FX-2180	3 mil character / 17.79 pin - 8 mil character / 60m, 196.8 ft x 13mm, 0.5" 24 pin - 12 mil character / 70m x 13mm, 0.5" 58 ft x 13mm, 0.5"
C13S015520	Ribbon, #8755(B), Asia	LX-1050 / 1170 / 1170 II FX-1170	3 mil character / 17.7m, 58 ft x 13mm, 0.5"
C13S015511	Ribbon, #7754(B), Asia	LQ-1150 / 1150 II	2 mil character / 12.4m, 40.6 ft x 13mm, 0.5"
C13S015589	Ribbon, S015337(B), Asia	LQ-590	5 mil character / 17m, 55.7 ft x 13mm, 0.5"
C13S015584	Ribbon, S015327(B), Asia	FX-2190 / FX-2175	8 mil character / 32m, 104.9 ft x 13mm, 0.5"
C13S015586	Ribbon, S015336(B), Asia	LQ-2090	8 mil character / 32m, 104.9 ft x 13mm, 0.5"
C13S015577	Ribbon, #8766(B), Asia	DFX-5000 / 5000+ / 8000 / 8500	15 mil character / 69.6m, 227.9 ft x 13mm, 0.5"
C13S015658	Ribbon, S015630(B), Asia	LQ-780/780N	10 mil character / 32.0m, 104.9ft x 13mm, 0.5"
C13S015508	Ribbon, S015016(B), Asia	LQ-670 / 680 / 680 Pro	2 mil character / 10m, 32.8 ft x 13mm, 0.5"
C13S015582	Ribbon, S015290(B), Asia	LQ-630	2 mil character / 8m, 26.2 ft x 13mm, 0.5"
C13S015587	Ribbon, S015066(B), STD	DLQ-3000 / 3000+ / 3500	6 mil character / 16.75m, 54.9 ft x 25.5mm, 1.0"
C13S015505	Ribbon, S015384(B), STD	DFX-9000	15 mil character / 70m, 229.6 ft x 13mm, 0.5"
C13S015569	Ribbon, S015077(C), STD	LQ-300 / 300+ / 300+II	1 mil character / 12.7m, 41.6 ft x 25.5mm, 1.0"
C13S015568	Ribbon, S015073(C), STD	LX-300 / 300+ / 300+II / 1170	1 mil character / 12.4m, 40.6 ft x 25.5mm, 1.0"
C13S015566	Ribbon, S015067(C), STD	DLQ-3000 / 3000+ / 3500	1.5 mil character / 16.75m, 54.9 ft x 25.5mm, 1.0"
C13S015571	Ribbon, S015139(B), STD	DLQ-3000 / 3000+ / 3500	9 mil character / 16.75m, 54.9 ft x 25.5mm, 1.0"
C13S015585	Ribbon, S015329(B), Asia	FX-890 / FX-875	7.5 mil character / 17.0m:55.7ft, 13mm, 0.5"
C13S015621	Ribbon Cartridge, S015621(B) ESP	LQ-50 / LX-50	3 mil character / 10.0m, 32.8 ft x 13mm, 0.5"
C13S015592	Ribbon, S015339 (B), ESP, 3PCS	PLQ-20 / M / D / DM	5 mil character / 36m, 118 ft x 6.5mm, 0.25"
C13S010074	Fabric Ribbon Pack Refill for S015086	LQ2070 / 2180 / 2080 / 2190 FX-2180	9 pin - 8 mil character / 60m, 196.8 ft x 13mm, 0.5" 24 pin - 12 mil character / 60m x 13mm, 0.5"
C13S010066	Fabric Ribbon Pack Refill for #7753 & #7754	LQ300 / 300+II / 580 and LQ1150 / 1150 II	2 mil character / 12.4m, 40.6 ft x 13mm, 0.5"
C13S010068	Fabric Ribbon Pack Refill for #8750 & #8755	LX300 / 300+ / 300+II and LX1050 / 1170 / 1170 II, FX1170	3 mil character / 17.7m, 58 ft x 13mm, 0.5"

# ROBOT SOLUTION



# Epson Robot

## A proven reputation for precision and reliability at the leading edge of industrial robot design

Ever since we developed our first SCARA robots for wristwatch assembly over 40 years ago, Epson has been a leader in advanced robotics technology. Today, our long experience in energy-efficient, compact, high-precision technologies enables us to offer a wide range of slim, compact, and lightweight robots. And with the addition of original Epson force sensing and image processing technologies, we are achieving even higher levels of reliability, speed, precision, and productivity in process automation. Whatever challenges you face, Epson industrial robots are continuously evolving to meet the diversifying needs of manufacturers worldwide.

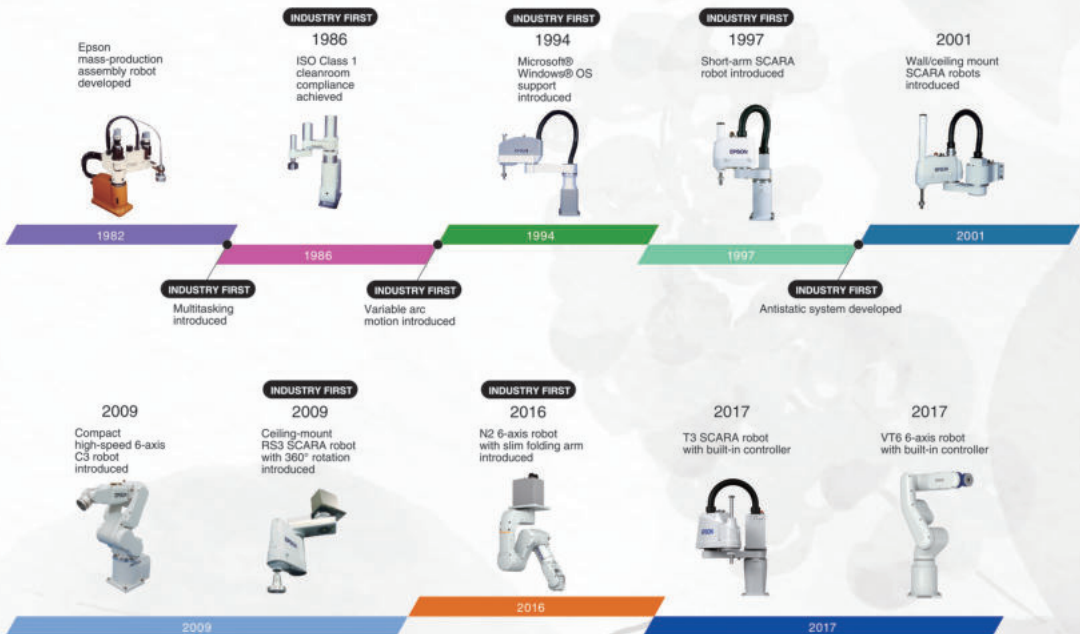

## Why Epson Robots ?

Epson, the global leader in robotics technology, offers you an impressive combination of high performance and operating ease. Backed by a worldwide reputation for reliability and outstanding customer support, Epson robots are bringing high-productivity automated manufacturing to an ever-expanding range of industries worldwide.



## Low TCO and high reliability for the ultimate in automated productivity

### High productivity

- Proprietary Epson technology reduces residual vibration to ensure high speed and precision for reduced takt time.
- Slim, lightweight body design reduces work cell space requirements while enabling higher productivity.

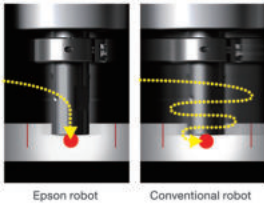

### High quality

- Extremely accurate toolhead positioning enables high-precision dispensing and cutting operations.

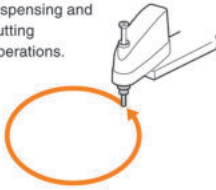

- Integrated machine vision systems boost setup ease and workpiece handling accuracy.

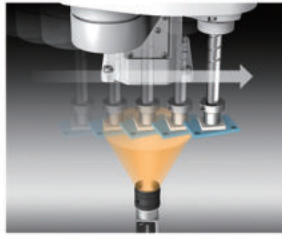

### Easy operation

- Intuitive graphical interface makes programming easy even for first-time users.
- From program testing to full production, improved operating ease helps reduce cost and manpower requirements.

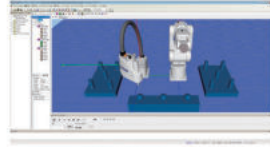

3D simulator for work cell layout and toolpath program testing

Software Integration

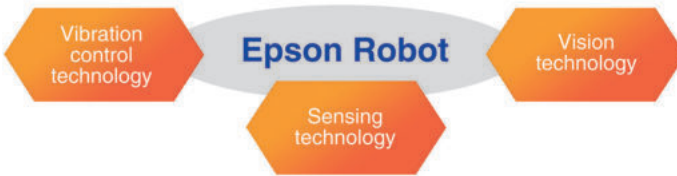

Global support

Epson supports robotics customers worldwide through an international network of sales and service offices, providing information about equipment configuration options and performing simulations of the tasks that customers want robots to perform. We are also partnered with systems integrators around the world, and can provide end-to-end turnkey solutions to meet virtually any process automation need.

# ROBOT SOLUTION









## Product lineup

	SCARA robots						
Epson Robot	G Series						
	Top-class speed, repeatability, and low residual vibration						
Publication page	▶P.9	▶P.11	▶P.15	▶P.17	▶P.21	▶P.23	▶P.23
Model name	G1	G3	<b>NEW</b> GX4	G6	<b>NEW</b> GX8	G10	G20
Payload (kg)	4-axis 3-axis 	Max 	Max 	Max 	Max 	Max 	Max 
Arm length (mm)							
Environmental specifications							
Installation specifications							
Compatible controller	RC700-A	RC700-A	RC700-D	RC700-A	RC700-D	RC700-A	RC700-A

# ROBOT SOLUTION



























SCARA robots							
LS Series				T Series		RS Series	
Proven reliability and functionality				Built-in controller for cost-efficient automation		Original space-saving design for high productivity	
▶ P.27	▶ P.29	▶ P.31	▶ P.33	▶ P.35	▶ P.37	▶ P.39	▶ P.41
LS3-B	LS6-B	LS10-B	LS20-B	<b>NEW</b> T3-B	<b>NEW</b> T6-B	RS3	RS4
							
Max 3	Max 6	Max 10	Max 20	Max 3	Max 6	Max 3	Max 4
400	500 600 700	600 700 800	800 1000	400	600	350	550
STD ★ Class 4	STD ★ Class 4	STD ★ Class 4	STD ★ Class 4	STD <sup>*2</sup>	STD <sup>*2</sup>	STD ★ Class 3	STD ★ Class 3
							
RC90-B	RC90-B	RC90-B	RC90-B	Built-in controller	Built-in controller	RC700-A	RC700-A

-  Standard
-  Cleanroom model ISO 03 (Class 10 equiv.) ESD suppression
-  Cleanroom model ISO 04 (Class 100 equiv.)
-  Cleanroom model ISO 05 (Class 100 equiv.)
-  Protection model IP54
-  Protection model IP65
-  Protection model IP67
-  Table Top mount
-  Wall mount
-  Ceiling mount
-  Wall/ceiling multi-layout mount

- \*1: See product page for details  
\*2: IP20 \*3: Standard model only
- Controllers**
  -  Controllers ▶ P.59
  - Software**
  -  Software ▶ P.62
  - Vision systems**
  -  Vision systems ▶ P.67
  - Force-sensing systems**
  -  Force-sensing systems ▶ P.70
  - Options**
  -  Software options ▶ P.74
  -  Robot controller options ▶ P.76
  -  Manipulator options ▶ P.79
  -  Option quick-reference table ▶ P.80
  -  Option setup example ▶ P.81

# ROBOT SOLUTION

## Product lineup

	<h3>6-axis robots</h3>		
	<h3>C Series</h3> <p>Slim, lightweight body for greater installation flexibility</p>		
Publication page	▶ P.43	▶ P.45	▶ P.49
Model name			
Payload (kg)	Max 	Max 	Max 
Arm length (mm)	 	  	
Environmental specifications		  	
Installation specifications	 	  	
Compatible controller			



# ROBOT SOLUTION

6-axis robots			
N Series			VT
Original compact design for greater freedom of movement in tight quarters			Compact, easy setup, low TCO
► P.51	► P.53	► P.55	► P.57
N2	N6-A850	N6-A1000	VT6L
			
Max  2.5	Max  6	Max  6	Max  6
450	850	1000	900
	 	 	  
 		 	   
RC700-A	RC700-A	RC700-A	Built-in controller

-  **STD** Standard
  -  **Class 3** Cleanroom model ISO 03 (Class 10 equiv.) ESD suppression
  -  **Class 4** Cleanroom model ISO 04 (Class 100 equiv.)
  -  **Class 5** Cleanroom model ISO 05 (Class 100 equiv.)
  -  **IP54** Protection model IP54
  -  **IP65** Protection model IP65
  -  **IP67** Protection model IP67
  -  Table Top mount
  -  Wall mount
  -  Ceiling mount
  -  Wall/ceiling multi-layout mount
- \*1: See product page for details  
\*2: IP20 \*3: Standard model only
- Controllers**
  -  Controllers ► P.59
  - Software**
  -  Software ► P.62
  - Vision systems**
  -  Vision systems ► P.67
  - Force-sensing systems**
  -  Force-sensing systems ► P.70
  - Options**
  -  Software options ► P.74
  -  Robot controller options ► P.76
  -  Manipulator options ► P.79
  -  Option quick-reference table ► P.80
  -  Option setup example ► P.81

## Vision systems

### 02 Vision Guide

Get advanced machine vision and image processing systems up and running fast with easy-to-use Epson Vision Guide software

- Built-in image processing engine assists vision-to-robot calibration, making it easy to align the robot's coordinate system with the camera's field of view.
- Workpiece position can be determined relative to robot coordinates without complex calculations.
- Image processing sequences can be created simply by entering a few parameters and pointing and clicking with a mouse.
- Advanced pattern matching and geometric search tools enable easy solution program development without writing a single line of code.

#### System configuration examples

##### CV-2A(HA, SA), L

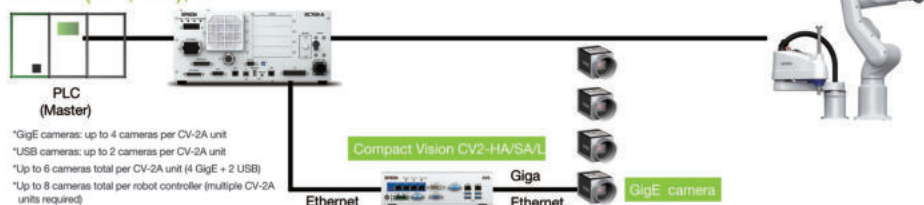

##### PV1

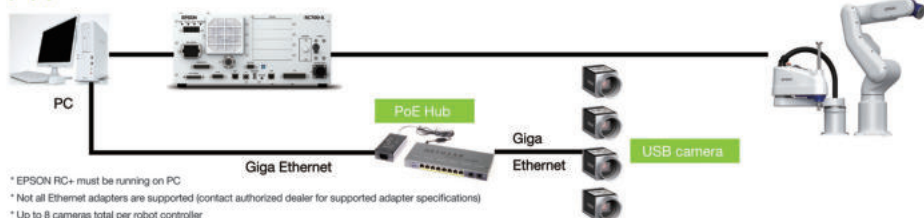

#### Features

##### Convenience

EPSON RC+ software can be used for both robot and machine vision program development.

- Other machine vision systems are more complicated to set up because different software must be used for machine vision and robot program development.

##### Ease of use

Easy registration of vision objects (positioning coordinates, etc.) enables rapid system setup and deployment.

- Vision objects can be registered via simple drag & drop operation.
- Intuitive interface makes operation easy even for first-time users.

##### ● Robot & Vision Programming

- Vision & Guide Window
- Simulator
- Jog & Teach Window

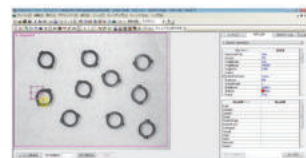
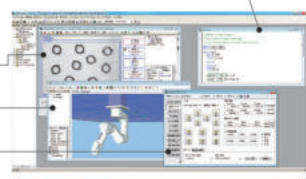

## Vision simulation

Epson Vision software includes a simulator that lets you visualize robot operation and workflow before equipment is actually installed. This makes it easy to plan and configure the system for maximum productivity, and allow program development to proceed while the system is being constructed.

- Vision and process sequencing can be prepared in advance, before system is installed.
- Programs that include image processing sequences can be tested off line.
- If workpiece images are available, image processing can be tested off line.

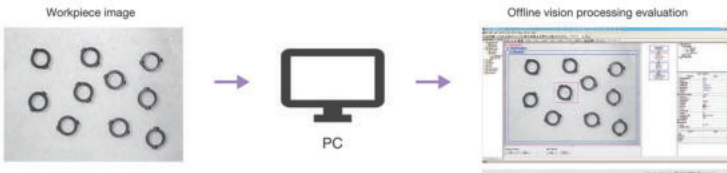

## Easy calibration

A built-in image processing engine makes it easy to align the camera's field of view with the robot's coordinate system, eliminating the need for complex programming when performing vision-to-robot calibration.

The robot automatically\*1 follows the steps in the Calibration Wizard to complete the calibration.\*2

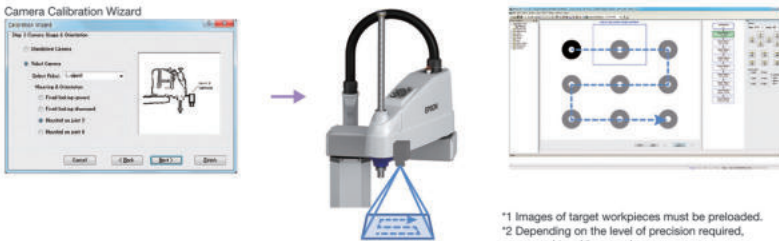

\*1 Images of target workpieces must be preloaded.  
\*2 Depending on the level of precision required, manual teaching may be necessary.

## One-stop service

Whether you need help with initial setup or active production lines, Epson gives you one-stop service convenience for both robot and machine vision systems. With only one service call instead of two to coordinate, your production line will be back up and running in no time.

## Force-sensing systems

High-rigidity, high-sensitivity S250 Series force sensors are specifically designed for use with Epson robots, enabling extremely precise force control for high-precision assembly tasks.

### 03 Force sensors

S250 Series force sensors incorporate exclusive Epson crystal piezoelectric technology that ensures a higher level of rigidity and sensitivity than conventional force sensors.

#### Advantage 1 high rigidity

S250 Series sensors are extremely rigid and resistant to deformation under heavy loads. They have a rated load of 250[N] on the X, Y, and Z axes, and a moment of force of 18[Nm] that makes them particularly sensitive to axial stress.

#### Advantage 2 high sensitivity

S250 Series sensors also ensure excellent sensitivity and quick response with high resolution of 0.1[N] and a low noise level of 0.035[N] on the X, Y, and Z axes.

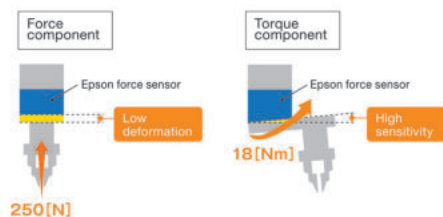

### Force-sensing system applications

Robots equipped with an Epson S250 Series force sensing system can handle high-precision tasks that cannot be safely automated with teaching or machine vision systems alone. As a result, even production processes that previously required experienced workers to handle delicate and easily damaged workpieces can be fully automated.

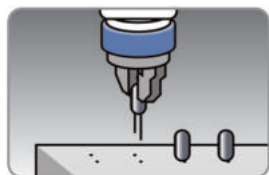

Delicate component assembly

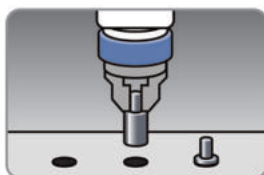

Precision mating

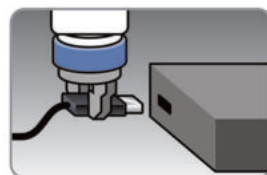

Connector insertion



Precision screw assembly



Fine polishing

### One-stop Epson support

From initial planning and procurement, to setup, adjustment, ongoing maintenance and re-pair, Epson provides one-stop support for all your force-sensing system and automation needs.



# ROBOT SOLUTION

High-rigidity, high-sensitivity S250 Series force sensors are specifically designed for use with Epson robots, enabling extremely precise force control for high-precision assembly tasks.

## Easy force sensing program development

The new Force Guide interface makes it easy to develop force sensor operating programs simply by dragging Force Guide object icons into a flow chart. In addition, simulator motion display and force waveform monitoring make debugging easier than ever before.



**Force Guide GUI**

The Force Guide interface provides a clear explanation of what each programming object does, as well as a flow chart view for easy confirmation of program sequence ordering.

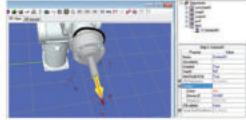

**Simulator**

The simulator enables quick confirmation of the direction of robot arm movement and axis coordinates.

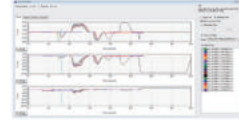

**Force waveform display & recording**

The force waveform display allows realtime waveforms to be compared with previously recorded waveforms, enabling users to identify operating anomalies and understand how various conditions affect performance.

## Direct teaching function

6-axis robots equipped with force sensors can be taught using the Epson TP2/TP3 teaching pendant. Operators can manually move the robot arm and manipulator to the desired position and use the teaching pendant to confirm hardness/softness of the workpiece and the force to be applied.\*

## Touch-jog function\*

In addition to the standard button-operated jog and teaching modes, the TP2 teaching pendant now has a direct teaching mode with a touch-jog function that makes 6-axis robot teaching much easier. During direct teaching operations, you can simply tap the effector to make small, incremental adjustments to the effector's position. There's no need to manually switch input modes because the system can automatically recognize the amount of force being applied to the effector.



\* Supported by TP2 teaching pendant and C4, C8, N2, and N6 robots (controller firmware v7.4.6 or newer required)

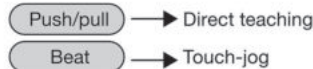

## Product photos

**03 S250 Series force sensor**



**03 FS2 communication module**



### FS2 system requirements

Supported controller	RC700-A One FS2 module per controller (inserted in option slot)
No. of supported force sensors	One sensor per module
Power supply	Via option slot

## System setup examples

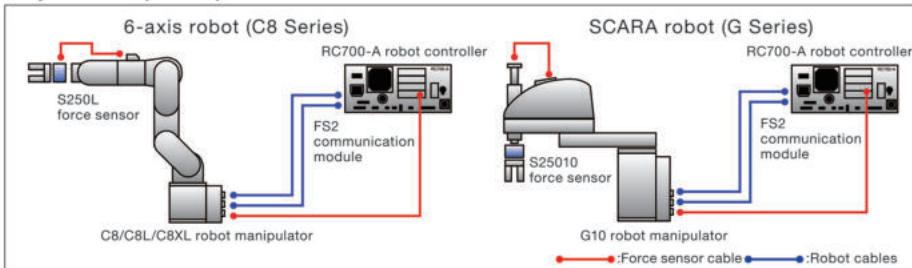

## Robot controller options

A wide range of controller options are offered to expand the range of tasks and processes that can be automated.

### 04 Teaching Pendant (TP3)

Compatible controllers  
RCPro-A RCPro-B T series VT series

Tablet-type teaching pendant with 10.1-inch color touchscreen for intuitive operation and fast, easy 6-axis robot teaching

#### Easy-to-view screen

- 10.1-inch TFT LCD (w/ LED backlight)
- 1280 x 800 resolution
- Color display

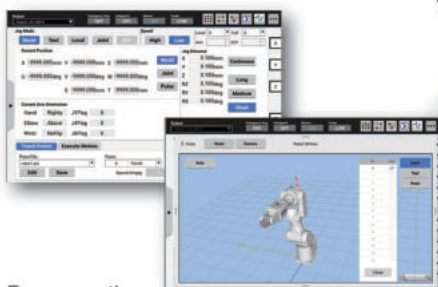

#### Easy operation

- Simple screen layout, fast response
- Standard RC+ program interface

#### Advanced features

- 3D robot graphics, programming functions and parameter settings
- High-speed test mode
- Programs can be started/stopped from operating panel

#### Main specifications

Dimensions (mm)	314(W) x 244(H) x 142(D)
Weight	1.5kg (excluding cable)
Body color	Black
Connectivity	Wired
Display	10.1-inch TFT LCD (w/ LED backlight) Resolution: 1280 x 800
Controls	Touchscreen controls Emergency stop button Enable switch Mode switch Control keys (JOG, EXE buttons) USB port
Cable length	5m (10m, 15m extension cables available)
Interface languages	English, Japanese, German, French, Chinese (simplified, traditional)
Ingress protection	IP65
Operating temperature range	0–40°C (stable temperature)
Operating humidity range	5–95% (relative humidity)
Operating environment	Low levels of dust, oil mist, salt, iron particles and other contaminants No flammable or caustic liquids or gases nearby

#### External dimensions

[Unit: mm]

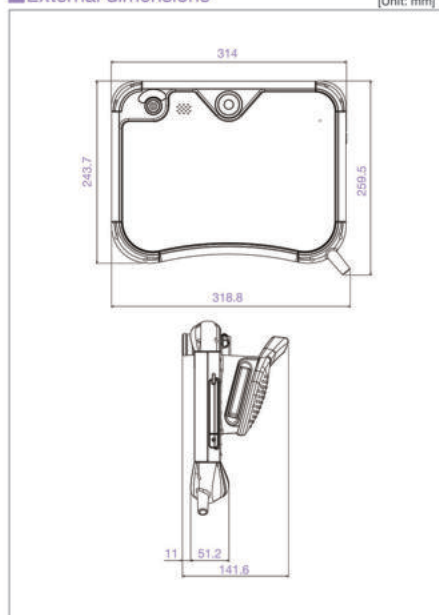

## 04 Teaching Pendant (TP2)

Compatible controllers  
RC700-A RC90-B T series VT series

### Easy-to-use pendant for teaching

- Universal design ensures ease of use for both right-handed and left-handed operators.
- Connects directly to operator unit or controller interface card.



## 05 Conveyor tracking

Compatible controllers  
RC700-A RC90-B T series VT series

### Precision tracking for high-productivity pick-and-place operation

- Enables pick-and-place handling of items on a high-speed conveyor.
- Uses machine vision/sensors to detect workpiece and effect robot handling.
- Can automate manual kitting/packaging tasks and help maintain productivity regardless of continuous/intermittent conveyor operation. Can also be used for workpiece assembly.
- Simple start/stop program execution.

\*Vision Guide software required.

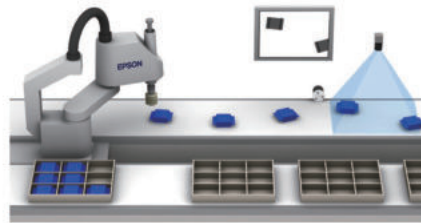

## 05 PG motion system

Compatible controllers  
RC700-A RC90-B T series VT series

### Control peripheral robots for fully integrated process automation

- EPSON RC+ software and pulse generator (PG) cards enable control of multiple third-party drives and motors.
- PG robots and standard EPSON RC+ system robots can be operated simultaneously, and controlled using the same commands.
- PG cards can be used to control X/Y tables, sliders, turrets,

and a wide range of other production/inspection line peripherals.

- Each PG card has 4 channels, and can support from 1 to 4 robots. Up to 4 cards can be mounted.

\*PG motion system requires optional EPSON RC+ software and at least one optional PG output board. Drivers and motors for third-party devices are not included.

## Robot controller options

### 06 Emergency stop switch

Compatible controllers  
RC100-A RC90-B T series VT series

Helps prevent injuries and damage

- Immediately stops robot operation in emergency situations.



### 07 RS-232C cards

Compatible controllers  
RC100-A RC90-B T series VT series

Expanded serial port connectivity

- 2-port RS-232C cards to connect serial interface devices.



### 08 I/O expansion cards

Compatible controllers  
RC100-A RC90-B T series VT series

Expanded input/output flexibility

- 24-input/16-output expansion cards.



### 09 Fieldbus I/O (slave)

Compatible controllers  
RC100-A RC90-B T series VT series

High-speed peripheral connectivity

- 2048-point I/O support for DeviceNet™, Ethernet/IP™, PROFIBUS®, and PROFINET® networked peripherals, and 384-point I/O support for CC-Link® networked peripherals.

### 10 Fieldbus I/O (master)

Compatible controllers  
RC100-A RC90-B T series VT series

Bidirectional high-speed peripheral connectivity

- Support for DeviceNet™, PROFIBUS®, and Ethernet/IP™ networked peripherals (1024-point I/O).

### 11 Analog I/O card

Compatible controllers  
RC100-A RC90-B T series VT series

For analog control of voltage and current I/O

- Analog control of input and output current and voltage allows regulation of secondary equipment such as paint sprayers to match the speed of robot arm motion. Available in 1 channel and 4 channel models.



### 12 EUROMAP 67 card

Compatible controllers  
RC100-A RC90-B T series VT series

For use with thermoplastic injection molding machines

- EUROMAP 67 compliant electrical interface with 15-point input and 16-point output.



### 13 I/O cable kit

Compatible controllers  
RC100-A RC90-B T series VT series

Cables and connectors for easy connectivity with no soldering required

- A wide range of I/O cables and connectors are available.



### 14 Hot plug kit

Compatible controllers  
RC100-A RC90-B T series VT series

Easy Teach Pendant connection/disconnection

- Allows Teach Pendant to be connected or disconnected without an emergency stop.

\*Conversion cable required for use with TP1 or TP2.



### 15 Wall mount option

Compatible controllers  
RC100-A RC90-B T series VT series

Optional wall mounting box

- Allows controller to be mounted on a wall.





## Manipulator options

Epson robot manipulator options provide the enhanced functionality and configuration flexibility you need for full-process automation.

### 16 External wiring units

Compatible manipulators

01	02	04	06	010	020	L01	L04	L08	L10	L15	T1	T1	V16	RS3	RS4	C4	C8	N2	N6
----	----	----	----	-----	-----	-----	-----	-----	-----	-----	----	----	-----	-----	-----	----	----	----	----

Simplifies wiring when mounting manipulator options

- Enables easy, on-site connection of external wiring by users.
- Ideal for connecting Vision Guide system camera cables or other wiring.



### 17 Internal wiring unit

Compatible manipulators

01	02	04	06	010	020	L01	L04	L08	L10	L15	T1	T1	V16	RS3	RS4	C4	C8	N2	N6
----	----	----	----	-----	-----	-----	-----	-----	-----	-----	----	----	-----	-----	-----	----	----	----	----

Enables wiring and conduits for the hand to be enclosed within the robot arm assembly.

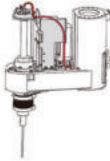

### 18 SCARA tool adapters

Compatible manipulators

01	02	04	010	020	L01	L04	L08	L10	L15	T1	T1	V16	RS3	RS4	C4	C8	N2	N6
----	----	----	-----	-----	-----	-----	-----	-----	-----	----	----	-----	-----	-----	----	----	----	----



Enhances handling/processing versatility and simplifies effector changes

### 19 ISO flanges

Compatible manipulators

01	02	04	010	020	L01	L04	L08	L10	L15	T1	T1	V16	RS3	RS4	C4	C8	N2	N6
----	----	----	-----	-----	-----	-----	-----	-----	-----	----	----	-----	-----	-----	----	----	----	----

For easy attachment of effectors to 6-axis robot arms

### 20 Brake release units

Compatible manipulators

01	02	04	010	020	L01	L04	L08	L10	L15	T1	T1	V16	RS3	RS4	C4	C8	N2	N6
----	----	----	-----	-----	-----	-----	-----	-----	-----	----	----	-----	-----	-----	----	----	----	----

Enables brake release so robot arm can be moved by hand when power is switched off at the leading edge of industrial robot design

### 21 Power and signal cables

Compatible manipulators

01	02	04	010	020	L01	L04	L08	L10	L15	T1	T1	V16	RS3	RS4	C4	C8	N2	N6
----	----	----	-----	-----	-----	-----	-----	-----	-----	----	----	-----	-----	-----	----	----	----	----

Standard 3m cables, or optional 5m and 10m cables for greater freedom in controller and robot placement

### 22 Power cable connectors

Compatible manipulators

01	02	04	010	020	L01	L04	L08	L10	L15	T1	T1	V16	RS3	RS4	C4	C8	N2	N6
----	----	----	-----	-----	-----	-----	-----	-----	-----	----	----	-----	-----	-----	----	----	----	----

Power cables are available with straight or L-shaped angle connectors\*



### 23 Camera mounting bracket

Compatible manipulators

01	02	04	010	020	L01	L04	L08	L10	L15	T1	T1	V16	RS3	RS4	C4	C8	N2	N6
----	----	----	-----	-----	-----	-----	-----	-----	-----	----	----	-----	-----	-----	----	----	----	----

Securely mount machine vision system camera to robot arm



Bracket design varies according to robot; please specify model when ordering.

# ROBOT SOLUTION

## Option quick-reference table

Software options					
	RC700-A	RC700-D	RC90-B	T series	VT
02 Vision Guide 7.0	●	●	●	●	●
03 Force Guide 7.0	●	●	—	—	—
RC+ API 7.0	●	●	●	●	●
ECP	●	●	●	●	●
GUI Builder 7.0	●	●	●	●	●
OCR	●	●	●	●	●
VRT	●	●	●	●	●

Controller options					
	RC700-A	RC700-D	RC90-B	T series	VT
04 Teaching Pendant (TP2)	●	●	●	●	●
04 Teaching Pendant (TP3)	●	●	—	●	●
05 Conveyor tracking	●	●	●	—	—
05 PG motion system	●	●	●	—	—
06 Emergency stop switch	●	●	●	●	●
07 RS-232C cards	●	●	●	—	—
08 I/O expansion cards	●	●	●	—	—
09 Fieldbus I/O (Slave)	●	●	●	●	●
10 Fieldbus I/O (Master)	●	●	●	●	●
11 Analog I/O card	●	●	●	—	—
12 EUROMAP 67 card	●	●	●	—	—
13 I/O cable kit	●	●	●	—	—
14 Hot plug kit	●	●	—	●	●
15 Wall mount option	●	●	—	—	—

Manipulator options															
	G1	G3	G4	G6	G8	G10/G20	LS3/L8/L10/LS20	T3-B/T8-B	RS3/RS4	C4	C8	N2	N8	VT8	
16 External wiring units	—	—	—	●	●	●	—	—	—	—	—	—	—	●	
17 Internal wiring unit	—	—	—	—	—	—	—	—	●	—	—	—	—	—	
18 Tool adapters/ISO flanges	—	●	●	●	●	●	●	●	●	—	●	●	●	●	
20 Brake release units	—	—	—	—	—	—	—	—	—	●	●	●	●	—	
21 Power and signal cables	●	●	●	●	●	●	●	(built-in controller)	●	●	●	●	●	(built-in controller)	
Cable length (m)	3,5,10,15,20						3,5,10		3,5,10,15,20						
Cable type (Standard/High-flex)	Standard								Standard	Standard/High-flex	Standard	Standard/High-flex			
22 Power cable connectors (Straight/L-type)	Straight/L-type						Standard		Straight/L-type						
23 Camera mounting bracket	—	●	●	●	●	●	●	●	●	●	●	●	●	●	
RC700DU-A (Drive unit)	●	●	—	●	—	●	—	—	●	●	●	—	●	—	

# ROBOT SOLUTION

## Option setup example

### RC700-A controller with C series robots

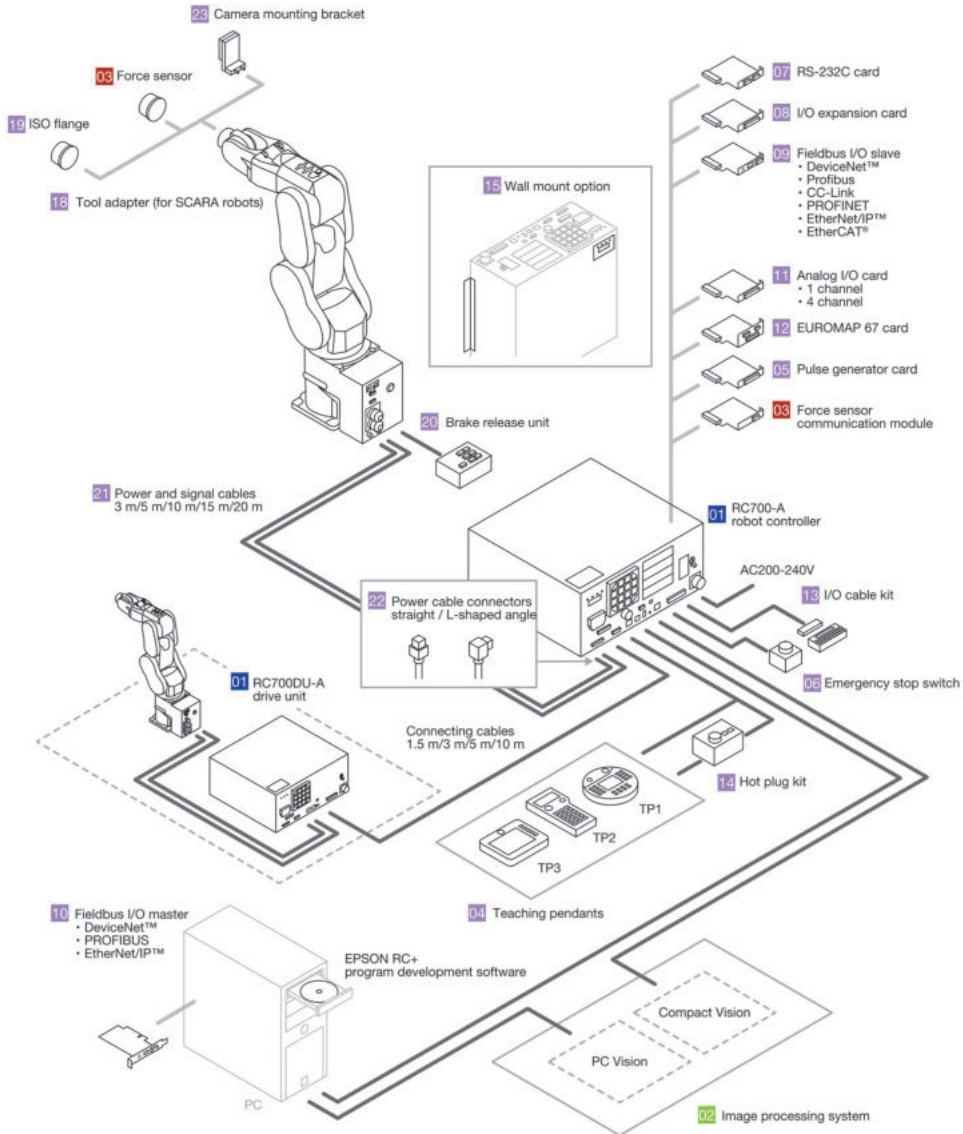

# ROBOT SOLUTION

## Option setup example

### RC90-B controller

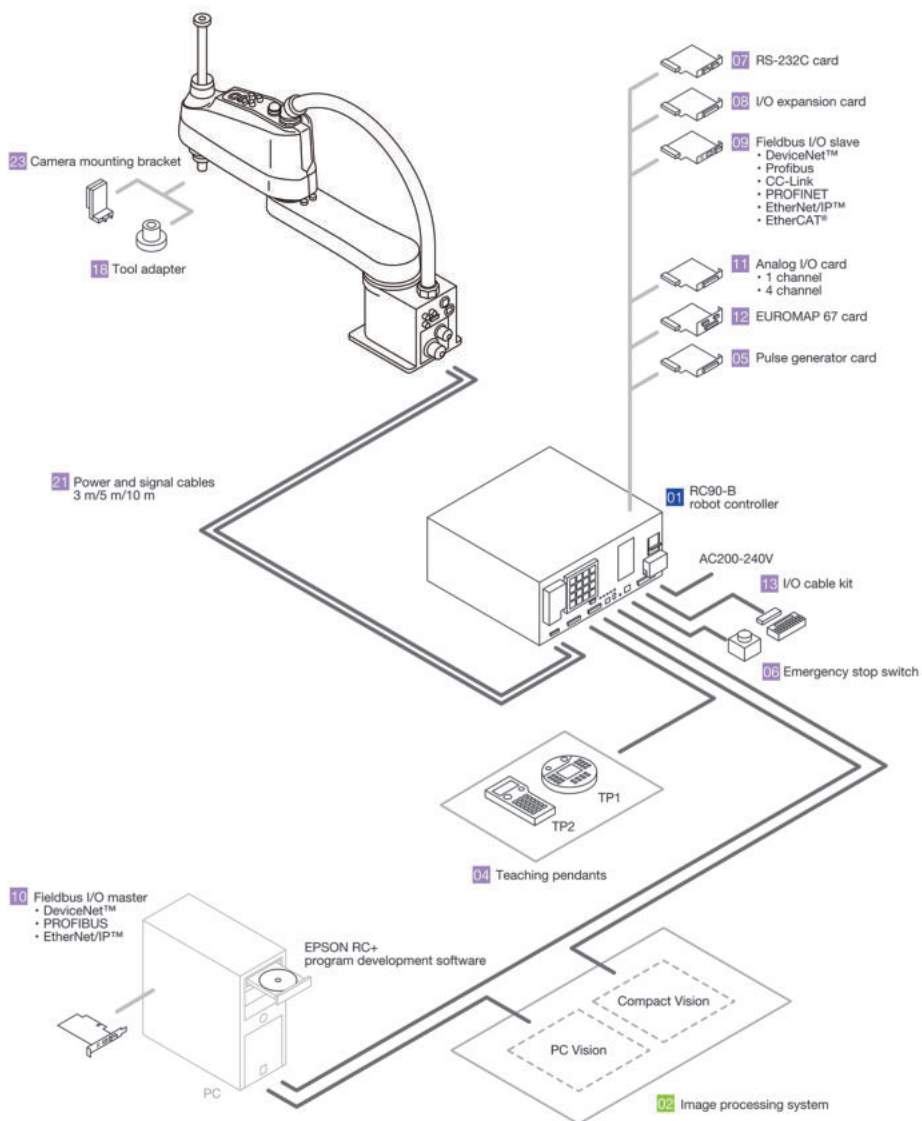

# ROBOT SOLUTION

## T series robot

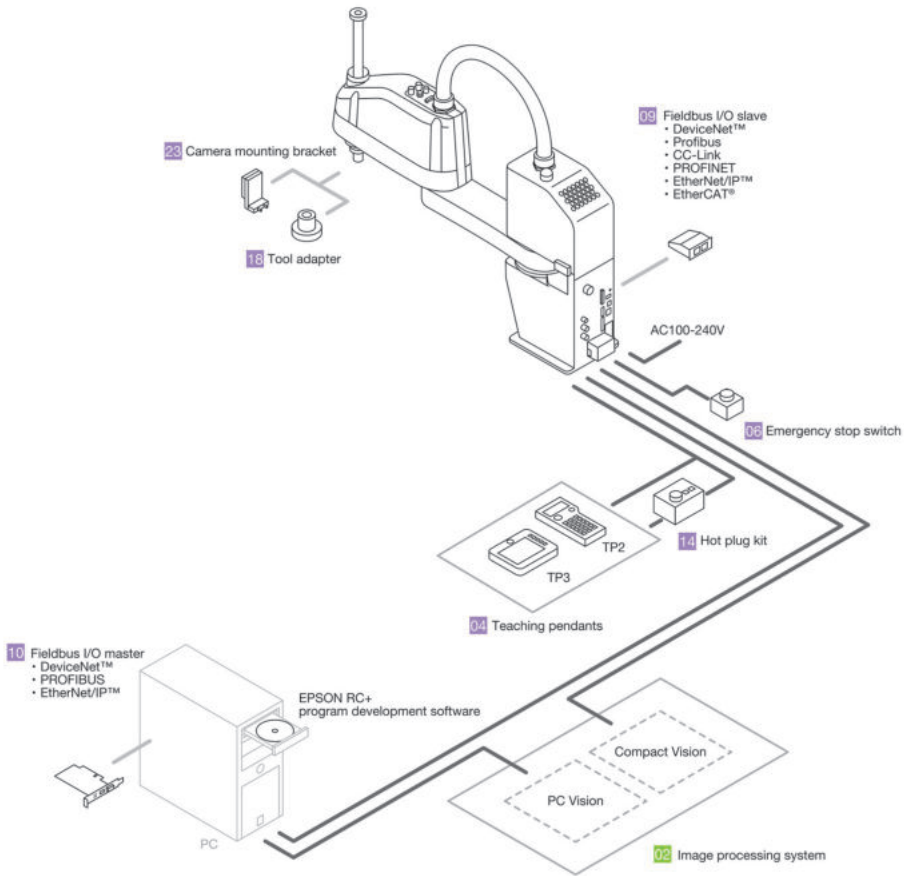

# ROBOT SOLUTION

## Option setup example

### VT series robot

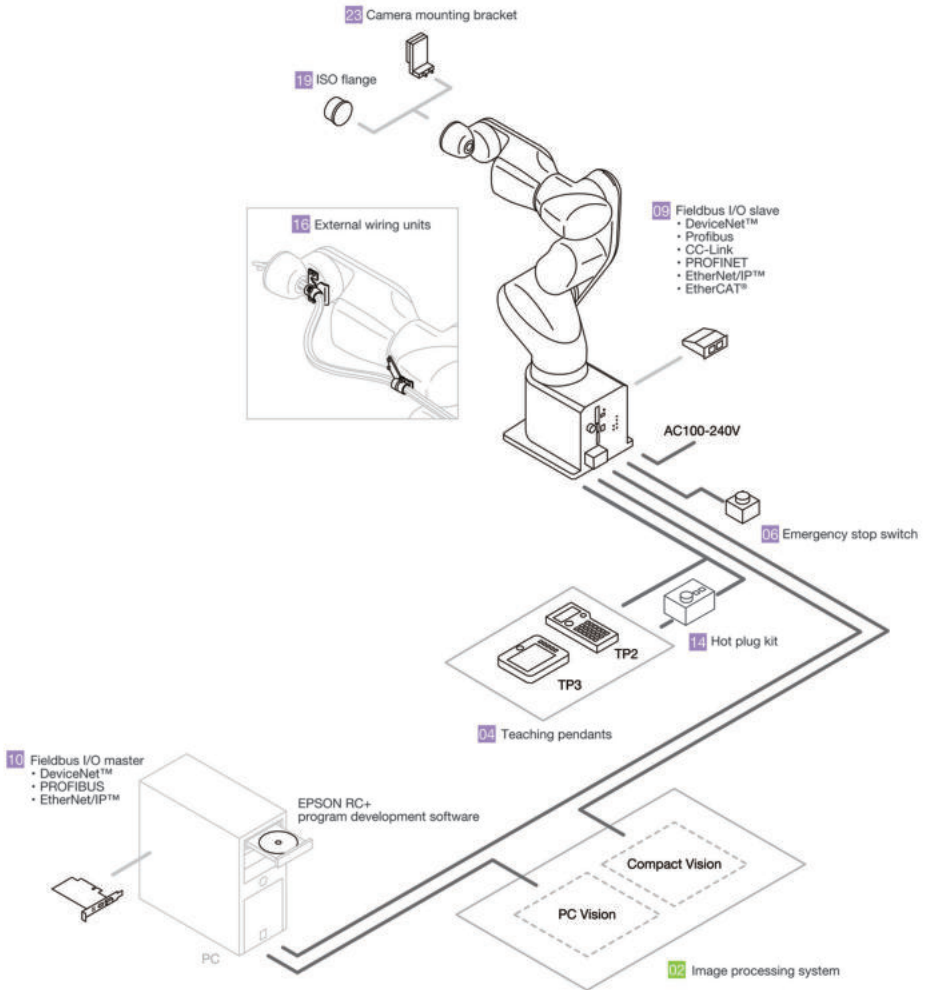

# BRINGING AUTOMATION TO THE NEXT LEVEL.

ROBOT SOLUTION



Epson Robots are built for greater efficiency and precision while fusing form and function. Equipped with an optional complementary force sensor that is both sensitive and versatile, the robots are capable of executing a wide range of high precision tasks. Details make all the difference in the world of automation. Experience lower production costs, enhanced quality and increased productivity with Epson's highly reliable robots, while increasing businesses' bottom line.



## IT'S IN THE DETAILS.

A global leader in precision robotics,  
Epson robots redefine reliability,  
accuracy and speed

# EPSON

# TRANSFORMATION. DETAILS MAKE THE DIFFERENCE.

ROBOT SOLUTION

## All-in-one SCARA T3

Space-saving compact design, built-in controller for simple configuration – ensures high productivity with minimum downtime, significantly reducing total cost of ownership.

## Folding-arm 6-Axis N2

All-new folding arm mechanism – a world first in 6-axis robot design – enables complex, high-precision assembly tasks to be performed in extremely limited spaces.

## Compact 6-Axis C8

High performance in a slimline package, allows payloads up to 8Kg while maintaining fast speeds and cycle times. Water and dust resistant. Can be wall or ceiling mounted.

## Long-reach SCARA LS6

Added reach and payload capacity, small footprint, proven reliability with outstanding functionality and cost-performance for pick-and-place and assembly tasks.

## Enjoy the advantages of automation with Epson Robots.

Some manufacturing industries seek automation, but require the tools to upgrade from manual production. Others want to learn more about the possibilities and benefits of automation before progressing.

Whatever stage you're at right now, take a look at the advantages of the industry-changing technology built into Epson robots. With incredible sensitivity, our amazingly-precise, outstandingly-reliable robots complete tasks that previously defied automation. Enabling solutions that increase your productivity and enhance your reputation, while reducing your costs.

Transform your production line and your bottom line, with Epson. Remember, it's in the details. [epson.co.id/industrial-robots](http://epson.co.id/industrial-robots)

**EPSON**





# 2023 PRODUCT CATALOGUE

# EPSON

## PT EPSON INDONESIA

CIBIS Tower 9, 3<sup>rd</sup> Floor, Cibis Business Park  
Jalan T.B. Simatupang No. 2 Jakarta 12560  
Tel. (021) 808-66-766 Fax. (021) 808-66-799



**1-500-766**



**0812-12-37766**

HOTLINE CALL CENTER  
(NATIONAL AREA)



Follow us

**@EpsonIndonesia**

[www.twitter.com/EpsonIndonesia](http://www.twitter.com/EpsonIndonesia)



Become our fans

**Epson Indonesia**

[www.fb.com/EpsonIndonesia](http://www.fb.com/EpsonIndonesia)



Follow Us

**Epson Indonesia**

[www.linkedin.com/company/epson-indonesia](http://www.linkedin.com/company/epson-indonesia)



Follow Us

**EpsonIndonesia**

[www.instagram.com/EpsonIndonesia](http://www.instagram.com/EpsonIndonesia)



Visit Us

**Epson Indonesia**

[www.epson.co.id](http://www.epson.co.id)



Visit Us

**Epson Indonesia**

[www.youtube.com/EpsonIndonesia](http://www.youtube.com/EpsonIndonesia)