



2024 PRODUCT CATALOGUE

2024-2025 Edition



EPSON

PT EPSON INDONESIA
CIBIS Tower 9, 3rd Floor, Cibis Business Park
Jalan T.B. Simatupang No. 2 Jakarta 12560
Tel. (021) 808-66-766 Fax. (021) 808-66-799

 **1-500-766**

 **0812-12-37766**

HOTLINE CALL CENTER
(NATIONAL AREA)

Follow us
 **@EpsonIndonesia**
www.twitter.com/EpsonIndonesia

Become our fans
 **Epson Indonesia**
www.fb.com/EpsonIndonesia

Follow Us
 **Epson Indonesia**
www.linkedin.com/company/epson-indonesia

Follow Us
 **EpsonIndonesia**
www.instagram.com/EpsonIndonesia

Visit Us
 **Epson Indonesia**
www.epson.co.id

Visit Us
 **Epson Indonesia**
www.youtube.com/EpsonIndonesia

EPSON

ENGINEERED FOR good

EPSON

2024 PRODUCT CATALOGUE

2024-2025 Edition

BE COOL AND SAVE THE WORLD



2024 PRODUCT CATALOGUE



TABLE OF CONTENT

- 03** INTRODUCTION
- 06** OUR SERVICES
- 14** OUR PARTNER
- 24** INKTANK PRINTER
- 35** PORTABLE PRINTER
- 44** INK CONSUMABLE
- 46** BUSINESS INKJET PRINTER
- 72** COMMERCIAL & INDUSTRIAL PRINTER
- 96** BUSINESS & PHOTO SCANNER
- 112** 3LCD PROJECTOR
- 144** TM PRINTER
- 154** LABEL INKJET PRINTER
- 162** LABEL PRINTER
- 170** DISC PUBLISHER
- 174** DOT MATRIX PRINTER
- 186** ROBOT SOLUTION





MENGHADIRKAN INOVASI DI SETIAP LANGKAH

Merayakan Ulang Tahun ke-24 Bersama Karyawan, Mitra, dan Pelanggan Setia

Merayakan 24 tahun perjalanan Epson Indonesia adalah momen berharga untuk mengenang setiap pencapaian dan mengungkapkan rasa syukur kepada karyawan, mitra, dan pelanggan yang telah menjadi bagian penting dari kisah sukses kami. Keberhasilan ini tak lepas dari dedikasi luar biasa dari setiap individu yang telah berkontribusi, mulai dari tim internal hingga dukungan pelanggan dan mitra bisnis yang penuh loyalitas.

Para karyawan dan pelanggan kami adalah kekuatan penggerak inovasi Epson Indonesia, dan kontribusi mereka tidak ternilai dalam mewujudkan setiap visi kami. Terima kasih yang sangat besar kepada pelanggan yang telah mempercayai kami dan juga atas kemitraan yang terus terjalin. Hubungan ini lebih dari sekadar bisnis ini adalah komitmen yang kami junjung tinggi dengan sepenuh hati.

Perjalanan kami masih panjang, dan pencapaian ini hanya bagian dari perjalanan dan di masa depan kami berkomitmen untuk terus menciptakan inovasi yang memberikan dampak positif bagi seluruh pemangku kepentingan. Bersama, kita akan melangkah ke tingkat yang lebih tinggi

Kepada seluruh karyawan, mitra, dan pemangku kepentingan, kami mengundang Anda untuk bergabung dalam perayaan ini. Mari kita berbagi kebahagiaan, menyatukan visi, dan terus berkolaborasi untuk meraih masa depan yang penuh potensi dan tumbuh terus bersama.

Terima kasih atas dukungan yang luar biasa selama 24 tahun ini!

Ng Ngee Khiong
Managing Director
of Epson Indonesia



EPSON INDONESIA COVERAGE AREA



9 DEDICATED
AUTHORISED
SERVICE PARTNER

178 AUTHORISED
SERVICE
PARTNER

29 CORPORATE
SERVICE
PARTNER



18 NATION-WIDE DISTRIBUTOR

102 AUTHORISED MASTER DEALER

743 AUTHORISED DEALER

EPSON DEDICATED ASP

City	Address	Phone
Banjarmasin	Jl. Gatot Soebroto No. 153 Banjarmasin - Kalsel 70235	1-500-766
Batam	Jl. Komplek Bumi Indah blok V No. 14, Kel. Lubuk Baja Kota, Kec. Lubuk Baja, Kota Batam, Prov. Kepulauan Riau 29444	1-500-766
Cirebon	Ruko Flamboyan, Jl. Pemuda Raya No. 36 Sunyaragi, Kesambi, Cirebon, Jawa Barat 45132	1-500-766
Jakarta	Wisma Keiai Lt. 1 Jl. Jenderal Sudirman Kav. 3 Jakarta Pusat - Dki Jakarta 10220	1-500-766
Jakarta - Adhitama	Jl. Ir. H. Juanda No.8 14, RT.14/RW.4, Kb. Klp., Kecamatan Gambir, Kota Jakarta Pusat, Daerah Khusus Ibukota Jakarta 10120	021-3455521
Jember	Jl. Panglima Besar Sudirman Ruko No.1D Jember-Jawa Timur (Depan Balai Penelitian & Pengolahan Kakao) 68118	1-500-766
Palu	Jl. Juanda No.58 - Palu 94111	1-500-766
Samarinda	Jl. Kh. Wahid Hasyim (M. Yamin) Kel. Sempaja Selatan, Kec. Samarinda Utara - Samarinda, Kaltim 75119	1-500-766
Surabaya Barat	Jl. H.Abdul Wahab Saimin, Ruko Villa Bukit Mas Rm-11 Rt.01 Rw.07 Kel. Dukuh Pakis Kec. Dukuh Pakis, Surabaya - 60225	1-500-766

EPSON CUSTOMER CARE.

Feel free to contact us



**JAM OPERASIONAL EPSON CUSTOMER CARE DI
SENIN – SABTU , 07:00 – 19:00 WIB**

customer.care@ein.epson.co.id

Visit Us on [epsonindonesia](https://www.epsonindonesia.com) www.epson.co.id

SOLUSI NYAMAN UNTUK PRODUK EPSON ANDA.

CoverPlus Extended Warranty

Epson Cover Plus merupakan paket servis yang memungkinkan pelanggan dapat memperpanjang masa garansi hingga **5 tahun**.



Untuk info lebih lanjut mengenai **Cover Plus Epson Extended Warranty Service** dapat menghubungi Epson Call Center

1-500-766

EPSON AUTHORISED SERVICE PARTNER

City	Name	Address	Phone
Abepura	Dunia Computer	Jl. Raya Abepura, Samping Pengadilan Negri Abepura - Papua	0967-5185007 99351
Ambon	HI-Tech Computer	Jl. Imam Bonjol No. 12, Ambon - Maluku	0911343434
Balikpapan	Widya Wisesa	Komp. Pantai Mas Permai Blok B No.14, Jl. Jend. Sudirman, Balikpapan-Kaltim	085258823802 76100
Banda Aceh	Angkasa Putera Abadi	Jl. T. Panglima Polem no. 141 Banda Aceh	0651-636026 23122-NAD
Bandar Lampung	CV. Rai Inkpart Computer	Jl. Diponegoro No. 121F, Sumur Batu, Teluk Betung, Lampung	0721 5602431 / 0721 486163 / 0813 69025565 35214
	Mahirnet Servisindo	Jl. Kartini No. 134, Tanjung Karang, Bandar-Lampung, Lampung	085100470090 35116
Bandung	MIP Bandung	Ruko ITC Kosambi Blok D1, Jl. Baranangsiang Kel. Kebo Pisang Kec. Sumur Bandung, Kota Bandung -	2220536911 40112
	CN Computer	Jl. Taman Kopo Indah 2 Ruko 1A No. 37 Bandung - Jawa Barat	022-5427034 / 02254413777 40262
	PT. Teknika Sarana Gardian (Bandung)	Jl. Cihampelas No. 48B, Tamansari, Kec Bandung Wean, Kota Bandung, Jawa Barat	0895325593059 40116
Banjarbaru	CV. Twincom	Jl. Panglima Batur Timur Rt02 No.06 (Deretan Rs. Mawar) Banjarbaru	08115138800 70711
Banjarmasin	Berlin Komputer	Jl. Kol Sugiono No.19, Banjarmasin. Kalimantan-Selatan	0511 3260228; 0511 410750 70233
	CV. Multi Prima	Jl. Veteran No. 8-9 Rt 07/01 Kel. Kuripan Banjarmasin - Kalsel	0511-3277154 70236
Barabai	CV Hidayah Technology	Jl. Ulama RT. 6 No. 23 Barabai Kab. Hulu Sungai Tengah, Kalimantan Selatan	0517-41051 71314
Batam	Muracom	Ruko Rafflesia Blok B No. 8 Batam Centre - Batam Kepri	08127538755 29461
Batulicin	CV Smart Jaya Tech	Jl. Pesantren No. 71 Batulicin, Tanah Bumbu, Kalimantan Selatan	081349559909 72171
Baturaja	CV. Jasu sri Wahyu (Digicom)	Jl. Jend Ahmad Yani No.14B, Air Karang, Desa Tanjung Baru, Baturaja, Ogan Komering Ulu, Sumatera Selatan	0735-326634 32121
Bekasi	XYZ-Go Print	Ruko Suncity Squire Blok A-21 Jl.Mayor Madmuin Hasibuan Margajaya Bekasi Selatan Kota Bekasi	081398362722 17141
Bengkayang	CV. Harindo	Jl. Sanggau Ledo No. 24 Rt.04/Rw.02 Sebopet, Bengkayang - Kalbar	0562-4442340 79284
Bengkulu	CV. Biru Teknologi Multimedia	Jl. Mt Haryono No 19B Kampung Bali - Bengkulu	0736-28548 38114
Bima	Sentral Muslim	Jl. Soekarno Hatta, No.77, Kota Bima, Ntb	0374-646806 84111
Bireuen	CV. Putra Solusindo Computer	Jl Medan B Aceh No 15 Bireuen - Aceh	0644-22709 24211
Bitung	Smart Computer	Jl. H. V. Worang No.2, Kel.Kadoodan Kec. Madidir, Bitung - Sulut	0438-30805 95513
Bogor	PT. Gerai Servis Indonesia	Ruko Taman Yasmin Sektor VI No. 138 Jl. KHR abd. Bin M Nuh Bogor	0251-7592054 16113
	PT Sukses Komputindo Abadi (Bogor)	Ruko Wr. Jambu, Jl Ciremei Ujung, No.1 RT.02/RW.05, Bantarjati, Kec. Bogor Utara, Jawa Barat	085210009827 / 0251-2000059 16153
Bojonegoro	Hitech Bojonegoro	Jl. Teuku Umar No 52 Bojonegoro	085231167031 62111
Bondowoso	Prince Computer	Jl. KH.Agus Salim 101 Blindungan Bondowoso	082281707337 Jatim 68212
Bone	Surya Indah Computer	Jl. Sukawati No.88, Bone, Sulawesi Selatan	0481-2921039 92713
Bontang	Ganeka Komputer	Jl. Bhayangkara No. 21 Bontang Kalimantan Timur	054824542 75311
Boyolali	XP Computer	Jl. Merbabu 18 Boyolali Jateng -	0276-320044 57311
Bukit Tinggi	Central Multi Computer	Jl. Raya Bukittinggi No. 120 Bukittinggi, Komp. Ruko Jambu Air Permai No.120, Sumbang	0752-7003688; 0752-625876 26181
Bulukumba	CV Media Computer	Jl. Cendana No.15, Bulukumba, Sulawesi Selatan	0431-2587988 92518
Ciamis	Micomp	Jl. Kh. A. Dahlan No. 5 Ciamis - Jawa Barat	0265-772636 46211
Cianjur	CV. Mitra Jaya Computindo (Digicom)	Jl. Moch Ali No. 62 Cianjur	0263-260789 / 087778888909 43214
Cibinong	PT. Gerai Servis Indonesia	Jl. Tegar Beriman No. 1 Blok A35 Pertokoan Cibinong City Center - Cibinong	021-29335280 16915
Cibubur	PT. Sukses Komputindo Abadi	Komplek Ruko Citra Gran, Jl. Alternatif Cibubur No.23, RT.001/RW.011, Jatikarya, Kec. Jatisampurna, Kota Bekasi, Jawa Barat	021-8452024 17435
Cikarang	PT. XYZ Go Print	Ruko Menteng Blok C No.9 Lippo Cikarang Bekasi	02188354971 17530
Cilegon	Star Media Tehnik	Jl. Kepodang No. 69 Kav. Blok F Cilegon - Banten	0812 1234 9045 / 087777101145 42415

EPSON AUTHORISED SERVICE PARTNER

City	Name	Address	Phone
Cimahi	CV. Niscaya Berkah	Jl. Jendral Amir Mahmud No. 603 Rt 02/010 Kel. Setiamanah Kec. Cimahi, Cimahi Jawa Barat 40524	022 665 2991
Ciputat	Macindo Pusat (Mitra Adiyasa Cemerlang)	Jl. Otista Raya, Rt 01/010 No 53G, Ciputat Tangerang Selatan 15411	021 2274 4044
Cirebon	CV. Mitra Indexindo Pratama	Jl. Basalamah No.59E (Panjunan), Lemahwungkuk, Kota Cirebon, Jawa Barat, 45112	0231-211673; 0231-245568
Ciwidey	Annisa Mandiri	Jl Siliwangi No. 38 Ciwidey, Kampung Puncak Mulya, Desa/ Kelurahan Mekarmaju, Kec.Pasirjambu, Kab. Bandung, Provinsi Jawa Barat, Kode Pos: 40972	022-85921579
Demak	Prima Komputer	Jl. Demak-Kudus No. 83, Tanubayan - Demak, Jateng - 59511	085292114696
Denpasar	MIP Denpasar	Jl. Raya Sesetan 53A, Ruko Sukma Cendana, Denpasar - Bali 80114	087875904915
	Rumah Printer	Jl. Pulau Batam No. 17, Dauh Puri Kauh, Kec Denpasar Barat, Denpasar Bali 80351	081908233350
	CV Indoprint Sejahtera Abadi (Denpasar)	Jl. Buana Raya No. 98D, Padangsambian, Denpasar Bali 80119	0818598818
Dumai	Maestro Komputer	Jl. P. Diponegoro No. 211 Dumai - Riau 28812	082382231199
Duri	Computer City	Jl. Jend Sudirman No.228 D Duri - Riau	0765 598008
			0765 598006
Garut	Central Computer	Jl. Cimanuk 273 Garut - Jawa Barat 44118	0262-235420
Gorontalo	Square Computer	Jl. S Parman No. 36A Kel. Biawao, Gorontalo - 96111	082188007111
Indramayu	Personal Komputer	Jl. MT. Haryono No. 2B Sindang Indramayu Jawa Barat 45221	087873735050
Jakarta	MIP Cideng	Cideng Barat No. 47 G2 Rt/ Rw 009/04 Kelurahan Cideng Kecamatan Gambir Jakarta Pusat- 10150	021-22632749
	PT. Teknika Sarana Gardian (Jakarta)	Jl.RS Fatmawati Rukan Golden Fatmawati (D'best) Blok J No.26, Jakarta Selatan 12560	021-75914343, 021-29042911
	MIP Warung Jati	Jl. Hajjah Tutty Alawiyah No.41B, RT.2/RW.5, Kalibata, Kec. Pancoran, Kota Jakarta Selatan, Daerah Khusus Ibukota Jakarta 12740 Ibukota Jakarta 12740	021-7946880
	PT. HSN Tech Indonesia (Fatmawati)	Ruko ITC Fatmawati Unit No. 7 Jl. Rs Fatmawati No. 39 Jakarta Selatan 12150	021-27513202
	PT. Faasri Utama Sakti	Jl. Raya Gading Indah No. 8 Kav. A4 Gading Permai, Jakarta-14240 (Belakang Mall La Piazza Kelapa Gading)	021-45844088
	Reksa Sekawan	Irc Permata Hijau Lt 3 Blok C11 No. 19 Jl.Ir. Soepeno Jakarta Selatan - Jakarta 12210	021-53663961
	PT. Berkah Tumbuh Bersama Indonesia (Bertubi)	Kompleks Ruko Mutiara Taman Palem, Blok C10 No. 53 Jl. Outer Ring Road, Kel. Cengkareng Timur, Kec. Cengkareng Jakarta Barat 11730	08111319598
	Jambi	CV. Eleven Jambi	Jl. Gatot Subroto No 10 Jambi 36134
Jayapura	CV. Master Computer	Jl. Percetakan Negara No. 94A, Jayapura - Papua 99111	0967-533588
Jember	Bitcom	P. Sudirman No. 58 Jember - Jatim 68118	0331-481822
Kabangjahe	CV. Mitra Computindo (d/h Era Baru Computer)	Jl. Padang Mas II No. 12, Kabangjahe Sumatra Utara 22115	0628-9032078
Karawang	Megatama Computindo	Jl. Arief Rahman Hakim No. 10B Karawang 41311	0267-8409202
Kebumen	Utama Computer Kebumen	Jl. HM Sarbini No. 66 Kebumen 54316	083128389688
Kediri	Sumber Tehnik Kediri	Jl. Joyoboyo 25E Banjaran, Kota Kediri Jawa Timur 64129	0354-688880
Kendari	Mentari Komputer	Jl. Dr Sam Ratulangi No.14 Mandonga kendari 93717	085242245196
Ketapang	Metro Computer	Jl. R. Suprpto No. 88, Ketapang, Kal-Bar 78812	0534-34355; 0534-35900
Kisaran	CV. F3i	Jl. Cokroaminoto No. 147 Kisaran Sumut 21214	0623 - 43647
Kotamobagu	Carper Computer	Jl. Veteran No. 21 Kel. Motoboi Kecil, Kotamobagu Komp. Manggala Sport Hall - Sulut 95711	0434-23338
Kuningan	Zigma Comp	Jl. Re. Martadinata 33 Cijoho Kuningan - 45513	0232-874608
Kupang	Duta Multi Computer	Ruko Lontar Permai Jl. Raya Wolter Monginsidi III Blok A 21 Kupang - NTT 85111	0380-828333/ 08308441428 / 08113829998
Lahat	CV Wangi Ratna Informatika	Jl Stasiun No.4 Pasar Lama, Lahat. Kab.Lahat	07321-3202005
Lamandau	My Computer dan Elektronik	Jl. Tjilik Riwut Rt. 02A Samping SDN Nanga Bulik Lamandau Kalimantan Tengah 74162	081220243666
Lampung	PT. HSN Tech Indonesia (Lampung)	Jl. Teuku Umar No. 157 Kedaton Lampung 35132	0721-705430
Lubuk Linggau	Sigma Komputer	Jl. Yos-Sudarso No. 19, Lubuk Linggau, Sumsel 31621	0733-324828

EPSON AUTHORISED SERVICE PARTNER

City	Name	Address	Phone
Lumajang	Lab Persada Computer	Jl. Wijaya Kusuma No. 11 Lumajang Jawa Timur 67315	0334-811411 / 0334-888221
Luwuk Banggai	Mitra Mandiri (Jaya Raya Com)	Jl. Sam Ratulangi No.141 Luwuk Banggai -Sulteng 94712	0461-21225
Madiun	Astro Madiun	Jl. Hos Cokroaminoto 53, Kejuron, Taman, Madiun - Jatim 63132	0351-472799
	Maju Hardware	Plaza Matahari Jl. Pahlawan No.38-40 Madiun - Jawa Timur 63121	0851-7247-5570
Magelang	Mikro Magelang	Jl. Tidar 24, Magelang Jawa Tengah 59214	0293 363453
Majalengka	Gemilang Prakarsa (Alfanet)	Jl. Kh. Abdul Halim No. 176 Majalengka - Jawa Barat 45418	0233-8285500
Makassar	Ariel Computer	Jl. G. Latimojong 163 A, Makassar. Sulawesi-Selatan 90141	0411 3610310
	MIP Makassar	Jl. Ap. Pettarani kompleks Pettarani Center blok B12, Bua kana, Rappocini, kota Makassar, Sulawesi Selatan 90233	0411 - 4669162
	Makassar Print	Jl. Gunung Bawakaraeng No. 68B1, Kel. Lariang Bangi Kec. Makassar Sulawesi Selatan 90141	0411-2558484
Malang	Angkasa Computer Center	Jl. T.G.P No. 1, Malang, Jawa-Timur 65112	0341 351000/ 0341 323222
	PT. Teknika Sarana Gardian (Malang)	Jl.Terusan Sulfat Kav.2 No.69 Pandanwangi, Blimbing Malang 65139	085109335522
Mamuju	Mahadewa Computer	Jl. Jend. Sudirman Kav 10 No. 2, Mamuju - Sulawesi Barat 91512	085100723588
Manado	PT. Master Media	Ruko Megasmart 5 No.11 Boulevard Jl. Pierre Tendean Manado - Sulut 95111	0431-8821658
	Intertech Computer	Jl. Aipda K.S Tubun No. 25 Istiql Manado, Sulawesi Utara 95121	0431 863560
Manokwari	Itech Service Indonesia	Jl. Drs. Esau Sesa Wosi, Manokwari (Samping X Advertising) 98312	081342012387
Mataram	Revayah Mataram	Jl. Sriwijaya, Pertokoan Sriwijaya No 9, (Depan Kura-Kura, Samping Indomart) Mataram - Lombok 83127	0878-6580-6395
Medan	MIP Medan	Jl. Prof. HM. Yamin Sh No.448, Sei Kera Hulu, Kec. Medan Perjuangan, Kota Medan, Sumatera Utara 20222	061-4553195
	Golden Dragon	Jl. Veteran No. 14D / 28 Medan - Sumut 20231	061-4567822; 061-77273158
Merauke	Padi Komputer	Jl. Parakomando No: 99 Merauke - Papua 99614	0971 - 322688
Metro	Zona Computer	Jl. Ah Nasution No. 67 A Kota Metro Lampung 34112	0725-48685
Meulaboh	CV. Multi Media	Jl. Manekro No. 38 Jurong V Gampong Kec Johan Pahlawan Meulaboh Aceh 23614	06557551722
Muara Bungo	PT. Mitra Komputer Bungo	Jl. Jend Sudirman KM 0 No. 67 Rt.09/02, (Sebelah Danamon & Rm. Jasum), Pasar Muara Bungo, Jambi 37212	0747-7331074
Nanga Pinoh	Komdisc Store.com	Jl. Juang Km. 2 No.77, Desa Tj. Niaga, Nanga Pinoh - Kalbar 79672	0568-22888
Pacitan	Surya Abadi Computer	Jl. Imam Bonjol No.34 Pacitan Jawa Timur 63512	0357-884534
Padang	Sinar Mulia Padang	Jl Belakang Tangsi II No 3A Padang - 25118. (Service)	085263086196
	CV. Maxindo	Jl. Kp. Nias V No. 7, (Belakang Pondok), Padang - Sumbar 25211	0751-38837; 0751-39119
	PT. HSN Tech Indonesia (Padang)	Jl Veteran No. 75C Padang 25117	075-1891116
Palangkaraya	Abadi Mitra Computer II	Jl. Galaksi Raya No. 7D, Palangkaraya - Kalteng 73111	0536-3238613
Palembang	Multikom	Jl. Lingkaran I No. 22, Palembang. Sumatera-Selatan 30113	0711 316008 / 0711 358205
Palopo	Aruna Multi Computer	Jl. Andi Kambo No. 19C Palopo - Sulsel 91921	0471-326461
Palu	Sara Com	Jl. S. Parman No. 61 Palu 94111	0451-4706614 / 085397751745
Pamekasan	Sarana Inti Data	Jl. Trunojoyo No. 115 Pamekasan, Madura - Jatim 69317	082332999177
Pangkal Pinang	CV. Duta Bintang Utama	Jl. Depati Hamzah No. 352 Pangkal Pinang Bangka 33684	0717-434485; 0717-9100526
Parigi	CV. Libra Com	Jl. Trans Sulawesi Kel Kampal Parigi Sulawesi Tengah 94471	085398852011 / 0811454530
Pasuruan	Aneka Sarana Computer	Jl. R.A. Kartini No. 12 Bangilan, Panggungrejo, Pasuruan - Jawa Timur 67114	0343-423739
Pati	Pati It Klinik	Jl. Kolonel Sunandar- Pati (Utara Stadion Joyokusumo Pati) 59163	085740526029
Payakumbuh	Indocomputer Payakumbuh	Jl. Soekarno Hatta No. 39, Payakumbuh Sumbar (Depan Rumah Bersalin Annisa) 26225	085322227406

EPSON AUTHORISED SERVICE PARTNER

City	Name	Address	Phone
Pekalongan	Mitra Komputer	Jl. H.A. Salim No. 63 Pekalongan 51127	0285-435431
Pekanbaru	Multi Media Computer	Jl. Prof Moh Yamin Sh No 55B Pekanbaru. Riau 28155	0761-46814/ 0761-856856
	Dwiwira	Jl. Dr Setia Budhi No. 107A Pekanbaru 28144 - Riau	0761-25977 0761-25189 0761-28891
	IT Pro	Jl. Tuanku Tambusai No. 8 C-D (Depan Pasar Buah/Family Box) Pekanbaru 28125	08531331058
Pemalang	CV. Irama Putra Mandiri	Jl Jendral Sudirman Timur No 95 Wanarejan Selatan Kec. Pemalang Kab. Pemalang Jawa Tengah	08112626911
Pematang Siantar	Asia Komputindo	Jl. Kartini No. 32E Pematang Siantar Sumut 21112	0622-5890388
Pontianak	Metro Computer	Jl. Gajah Mada No.87, Pontianak. Kalimantan-Barat 78123	0561- 742555/0561- 741610
	Datacom	Jl. Setiabudi No. 97A, Pontianak. Kalimantan-Barat 78122	085822397115
	CV. Irama Komputer	Jl. Prof M. Yamin RT 001/RW 001 Kel Kotabaru Kec. Pontianak Selatan Kalimantan Barat 78121	0811-5655-553
Probolinggo	Ridicomp	Jl. Ahmad Yani No. 152 Mangunharjo, kec Mayangan, Probolinggo - Jawa Timur 67217	0335-425858
	UD. Global Tech&Service	Jl. Mastrip 177 Kanigara Probolinggo Jatim- 67213	0335-434009 / 430447
Purwakarta	Putri Komputer	Jl. Ibrahim Singadilaga No. 64 Koncara - Purwakarta 41112	02648301614
Purwokerto	Indo Komputer Purwokerto	Ruko Satria Plaza Blok A No 1, Jl. Jend Sudirman, Purwokerto. Jawa Tengah 53114	0281-632500
	Tripio Computer	Jl. Dr. Angka No. 85 A, Purwokerto-Jawa Tengah 53114	0281-621908 / 081215428888
Putusibau	Mitra Computer	Jl. Komyor Ruko No. 2 Putusibau Kalbar 78711	0567-22835
Raha	RC Computer	Jl. Gatot Subroto (Depan Polsek Katobu) Kota Raha, Wamponiki, Katobu, Muna - Sulawesi Tenggara 93613	0852 41747222
Salatiga	Aston System	Jl. Imam Bonjol No.28 Salatiga	0298-326431
Samarinda	LiData Comp	Jl. Lambung Mangkurat 40, Samarinda. Kalimantan-Timur 75117	0541-739127 / 0541-736127 / 0541-7773002
Sampit	My Digital (CV. Teknologi Dunia Satu Keluarga)	Jl. Kapten Mulyono No.98A, Sampit - Kalteng 74323	0531-31335 / 085257667864
Sanggatta	Global Computer	Jl. Karya Etam No. 152B Sangatta Utara, Kutai Timur, Kalimantan Timur 75611	0549-2024148
Sanggau	Zoom Computer	Jl. Jend Sudirman No.19, Sanggau Kalbar 78512	0564-22181
Sekadau	CV. Neo Computer	Jl. Merdeka Timur Km. 02 Sekadau - Kalbar 79582	0564-2021012
Semarang	Compumart	Jl Singosari Raya No. 9 Semarang 50242	024 831 1199
	MIP Semarang	Jl. Indra Prasta No. 76B, Semarang - 50131	024-76433197
	CV Indoprint Sejahtera Abadi (Semarang)	Jl. Kanal 5F, Lamper Lor, Kota Semarang	
Serang	CV Faras Jaya Abadi	Jl. Raya Taktakan No. 1, Ciolang (Samping Café Erpeha), Serang, Banten 42162	0254-4076941
Serpong	PT. Kreatif Sinergi Teknologi	Jl. Buaran Raya, Jl. Raya Viktor, Buaran, Kec. Serpong, Kota Tangerang Selatan, Kode Pos 15310	0858 9710 1388
	Mitra Data	ITC BSD Lt.1 C6 No. 5, Jl. Pahlwan Seribu, Desa/Kelurahan Lengkong Wetan, Kec. Serpong, Kota Tangerang Selatan, Provinsi Banten, Kode Pos: 15322	0812 96079978
Sibolga	CV. Modern Computer	Jl. Imam Bonjol No. 107 Sibolga Tapanuli Tengah 22522	0631-27777 - 27888
Sidikalang	UD. Mitra Computer	Jl. S.M Raja No. 19 Kel Batang Beruh Kec Sidikalang Sumatra Utara 22212	081361398655
Sidoarjo	Matahari Makmur Computer	Jln. Monginsidi 49. Sidoarjo. Jawa Timur 61218	031-8069233
Singaraja	CV. Indotech	Jl. Ahmad Yani No. 55 Singaraja Kel Kaliuntu Kec Buleteng Bali 81114	0362-28123
Singkawang	CV. Central Computer	Jl. Yohana Godang No. F9 Rt. 26/07 Melayu - Sigkawang Barat Kalbar 79112	0562-638832
Sinjai	CV. Amalia Utama Computer	Jl. Manimpahoi No. 1 Kel Bongki, Kec Sinjai Utara, Sulawesi Selatan 92615	085225393335
Sintang	CV. Gloria Komputer	Jl. Wirapati Rt 001/001 Kel Kapuas Kanan Hulu, Sintang Kalimantan Barat 78614	085245872371

EPSON AUTHORISED SERVICE PARTNER

City	Name	Address	Phone
Sragen	Cahaya Komputer	Jl. Urip Sumoharjo No.156A, Gendingan Rt 04/Rw 09, Desa/ Kel.sragen Tengah, Kec. Sragen, Jawa Tengah, 57212	085712005055
Sorong	Toho Computer	Jl. Pramuka [Depan Polresta], Sorong Papua Barat 98411	082198322252
Subang	MS Computer	Jl. Arief Rahman Hakim No. 35 Subang - Jawa Barat 41213	0260-416126 / 7707733
Subulussalam	Esa Computer	Jl. Nyak Adam Kamil Dusun Pemancar Kel Penanggalan Barat, Kec. Penanggalan Kota Subulussalam Prov Aceh 24782	081269396969
Sudimara	PT. Tiga Samudera Adiperkasa	Komplek Ruko Kuta - Ubud Village Blok B21 Jl. HOS Cokroaminoto, Sudirman Timur Tangerang 15151	021-2905 2864
Sukabumi	RNY Com	Jl. Ahmad Yani No. 216/232 kec.Cikole. Sukabumi Jawa Barat 43112	085798882373
Sukamara	Sahabat Komputer dan Elektronik	Jl. Tjilik Riwut No. 30 Sukamara Kalimantan Tengah 74172	085252561656
Sumedang	CV. Semesta Komputama (Itstore)	Plaza Asia Sumedang GF 19-20 Jl. Prabu Gajah Agung No. 5 Sumedang Jawa Barat 45621	0261 2401412
Surabaya	Abadi Cipta Komputer MIP Surabaya	Jl. Ngagel Jaya No.41-43 Pucang Sewu Surabaya 60283	089656775100
		Ruko Sentra Fortuna, Jl. Jaksa Agung Suprpto 39 Kav. 20, Ketabang, Kec. Genteng Surabaya 60272	031-71758865; 031-5355460
	PT. HSN Tech Indonesia (Surabaya)	Jl. Kusuma Bangsa No. 25D Kel Ketabang Kec Genteng Surabaya 60272	0231-99299907
Surakarta	TSG Surabaya (Teknika Sarana Guardian)	Jl. Mayjen Sungkono Komplek Darmo Park. I Blok 2B No.11 Pakis, Kec. Sawahan, Surabaya Barat, Jawa Timur 60225	031-5677621 /0812-3580-887
	Prima Mitra Abadi	Jl. Veteran No. 211 Solo - Jateng 57155	0271-645350 / 0271-664847
	CV. Manxi Image Perkasa	Jl. Samratulangi No.19 , Joho, RT .06/RW.10 , Kel. Manahan, kec. Banjarsari, Surakarta.	0271 7462052 / 085100092986
Tanjung Balai Asahan	Star Computer	Jl. Sudirman No. 151 Tj. Balai Asahan Sumatra Utara 21332	082166446337
Tanjung Balai Karimun	Techno Infinity	Jl. A. Yani No. 5 Rt 03/06 Kel. Meral Karimun, Tj. Balai Karimun - Kepri 29664	0777-327578/ 082388332230
Tanjung Morawa	Family Computer	Jl. Perintis Kemerdekaan No. 9, Tanjung Morawa B, Deli Serdang - Sumut 20362	061-7940358
Tanjung Pandan	DNP Computer	Jl. Telex Rt 06/02 Air Merbabu - Tanjung Pandan Belitung 33411	0719-9223528
Tanjung Pinang	Force Computer	Jl. Raja Ali Haji No. 10, Tj.Pinang - Kepri 29124	0771-26888; 0771-314354
Tarakan	Plus-Plus Computer	Ruko Gusher Block C-10 Jl. Gajah Mada Tarakan - Kaltara 77111	0551-36120 / 0551-5542796
Tasikmalaya	Planet Computer	Jl. Selakaso No. 4, Tasikmalaya Jawa Barat 46121	0265 332223
Tegal	CV Indo Computer Tegal	Jl. Mayjen Sutoyo 14 Tegal 52125	0283-343500
	Graha Computer	Jl. AR Hakim No. 167, Desa/Kelurahan Mangkukusuman, Kec Tegal Timur, Kota Tegal, Provinsi Jawa Tengah	0283350140
Tembilahan	Matrik Perkasa	Jl. H Said No.03 (samping MM Gerry) Tembilahan, Indragiri hilir, Riau 29212	085271299600
Tenggarong	CV. Sentral Solusi Sejahtera	Jl. Kartini No. 22 Rt. 18, Tenggarong- Kutai Kartanegara Kaltim 75512	0541-665938
Ternate	PT. Datagrid Maestro Tekno	Jl. Raya Jati No. 17, Rt 03/02 Kel. Jati Ternate Selatan - Maluku Utara 97716	0921-6205567 / 081244029788
Timika	CV. Ithsan Infotika	Jl. Bhayangkara No. 39 Koperapoka, Timika - Papua 99910	0852 44523545
Tj. Redeb Berau	G Comp	Jl. Pemuda No.77 Tanjung Redeb, 77311	0821-1669-2222 / 05542122
Wonogiri	Raya Komputer (CV Raya Solusindo)	Jl. Ahmad Yani No. 56 Giripurwo Wonogiri - Jateng 57613	027-3323234
Yogyakarta	MIP Yogyakarta	Komp. Ruko Kuning No. 8 Jl. Ring Road Utara Condong Catur -Yogyakarta 55281	0274-557502
	Dot Print	Jl. Petung 1, Papringan - Jogjakarta 55321	0274-519725 / 085236139382
	CV. Top Distribusi	Kepuh Gk 3/953, Klitren, Gondokusuman, Yogyakarta 55222	0274-555475 / 08197555475

EPSON CORPORATE SERVICE PARTNER

CORPORATE SERVICE PARTNER

City	Name	Address	Phone
Batam	PT.Terang Inti Sejahtera	Ruko Four Season Blok B No. 21, Taman Duta Mas, Batam Centre, Batam - Kepri 29463	0778 - 469123 / 08527150333
Bekasi	PT Solusi Sukses Pratama	Ruko Sampoerna Square No. 12 Jl. Raya Kranggan No. 37A Bekasi Jawa Barat 17433	02128672601
	PT. Hade Multi Solusi	Graha Hade Jl. Wibawa Mukti II No.115, RT.003/RW.006, Jatiluhur, Kec. Jatiasih, Kota Bekasi Jawa Barat 17425	021-29062502
	PT. Polar Solusindo Utama	Ruko Kemang Permai No. 3A Jl. Siliwangi KM. 1 Sepanjang Jalan Rawa Panjang Bekasi 17114	021-82438202
	PT. Harmony Sistem	Jl. Dalang No. 8 Rawa Lumbu Bekasi Jawa Barat 17116	021-82401323
Jakarta	PT Air Mas Servisindo	Ruko Cobastroke KH Zainul Arfin 2 Komplek Ketapang Indah Blok B1 No.10 Ketapang, Jakarta Barat 11140	021-22636555 / 08529080800
	PT. Elang Mandiri Solusi	Pusat Niaga Roxy Mas, Jl. Kh Hasyim Ashari No.9-12, RW.8, Cideng, Kecamatan Gambir, Kota Jakarta Pusat, Daerah Khusus Ibukota Jakarta 10150	081299886009
	PT. Password Ritel	Jl. Jendral S. Parman Kav 77, Wisma 77 Tower 1 Lt. 15 Slipi, Jakarta Barat 11480	021-5363207
	PT. Albeta Sukses Mandiri	Jl. Kedoya Duri No.38A, RT.19/04, Kedoya Kec. Kb. Jeruk Jakarta Barat 11520	0215819908
	PT. Graha Digital Niaga	Ruko Duta Indah Alpha 2, Jl. Peta Selatan, Rt 08/01, Kalideres Jakarta Barat 11840	081383800314 / 08568445219
	PT. Data Retail Solution	Perkantoran Plaza Pasifik B4/81 Jl. Boulevard Barat Kelapa Gading, Jakarta Utara - 14240	021-4587 5368 / 4587 5369
	PT.Setia Sapta	Jl. Gajah Mada No. 183-184 Glodok Taman Sari Jakarta Barat 11120	021- 6296208 / 6499985
	PT. Intikom Berlian Mustika	Jl. Duren Tiga Raya No. 32 Rt 004/01 Duren Tiga, Pancoran, Jakarta Selatan 12760	021-52971700
	PT. Global Multimedia Technology	Jl. M Saari No 5 Rt 11/009 Sunter Jaya, Tanjung Priok, Tanjung Priok, Jakarta Utara 14360	021-22065580
	PT. Reycom Document Solusi	Jl. Raya Bekasi, Pulo Gadung, BizPark Commercial Estate Blok A.05 No. 07 & 09 RT.8/RW.4, Kel. Terate, Kec. Cakung Jakarta Timur	021-4244545
Malang	CV. Tunas Abadi	Jl. Jakarta No. 45B Malang Jawa Timur 65145	0341-580520 / 0341-570385
Semarang	CV. Mediadata Sejahtera	Jl. Menteri Supeno No.44B, Mugasari, Kec. Semarang Sel, Kota Semarang, Jawa Tengah 50249	08888545545
Surabaya	PT. Cahaya Inti Prima (3D Print Computer)	ITC Mega Grosir lantai.2 Blok G5 No. 1-3A, Jl. Gembong No. 20-30 Surabaya 60141	031-5476706 / 087852496899

LARGE FORMAT & INDUSTRIAL PRINTER

City	Name	Address	Phone
Bekasi	PT. Mandiri Artha Solusi	Ruko Sampurna Square, No.15 Jl. Raya Hankam Jatisampurna Kranggan Bekasi 17433 - Jawa Barat 17433	021-22813394 / 02128672601
Depok	PT. Indonesia Graphic	Komplek Rukan Graha Depok Mas Blok A No. 5, Jl. Raya Arief Rahman Hakim, Depok Jawa Barat 16423	021-7829245 / 083808821483
Jakarta	CV. Media Grafindo	Green Sedayu Bizpark, Blok Dm.15 No.72 Jl. Daan Mogot Km.18 Jakarta Barat 11840	021-543 15518 / 021-22520784
	PT. Mulia Mandiri Supply	Jl. Tongkol No. 6 BI, Ancol Pademangan Jakarta Utara- 14430	021-6910072
	PT. Samafitro Jakarta	Jl. Ir. H. Juanda No. 8 Jakarta Pusat - 10120	021-29495500
	PT. Aneka Warna Indah	Jl. Gn.Sahari N0.50A ,RT01/RW01, Gn.Sahari Sel, Kec. Kemayoran Kota Jakarta Pusat 10610	021-6511009
Serpong	PT. Laysander Technology	Ruko Golden Boulevard R/21 Serpong Utara Bsd Tangset - 15322	021-53161450
Surabaya	PT Samafitro Surabaya	Jemur Wonosari, Jl. Jemusari No. 313 Sidosermo, Kec Wonocolo, Kota Surabaya Jawa Timur 60299	031-841 3027 / 031-847 7779
	CV. 7 Droplet	Green Mansion Residence Blok N No. 12A, Jl. Ambeng-ambeng Selatan, Ngingas, kec Waru, Kab Sidoarjo, Jawa Timur 61256	031-85587722
Sidoarjo	CV. Wujud Unggul	Kompleks Pergudangan Indoserena Blok A-19, Jabon, Tambaksawah, Waru, Sidoarjo Jawa Timur	031 99852331 / 031 8480663 / 031-8410044
Surakarta	CV. Sinar Citra Pratama	Jl. Sutan Syahrir No 25 Solo 57129	0271 647630; 0811295876

EPSON NATION-WIDE DISTRIBUTOR

EPSON NATION-WIDE DISTRIBUTOR

Company Name	Address
PT PASIFIK INTERNUSA	Gedung Sudirman 7,8 Lantai 26 Unit 01-08, Jl Jendral Sudirman Kav. 7-8, Kel. Karet Tengsin Kec Tanah Abang. Kota Adm. Jakarta Pusat. Prov DKI Jakarta
PT SETIA SAPTA	Jl. Gajah Mada No. 183-184, Desa/Kelurahan Glodok, Kec. Taman Sari, Kota Adm. Jakarta Barat, Provinsi DKI Jakarta
PT SYNnex METRODATA INDONESIA	APL Tower Lantai 42, Suite 1 – 8, Jalan Letnan Jenderal Siswondo Parman Kaveling 28, Kel. Tanjung Duren Selatan, Kec. Grogol Petamburan, Kota Adm. Jakarta Barat, Prop. DKI Jakarta
PT PARON INDONESIA	Harco Mangga Dua Blok G No. 3 A-B, Jl. Mangga Dua Raya, Kel. Mangga Dua Selatan, Kec. Sawah Besar, Kota Adm. Jakarta Pusat, Prov. DKI Jakarta
PT REYCOM PRINTING SOLUSI	Jl. Macan No. 6 Blok B8 Daan Mogot, Kel. Kedoya Utara, Kec. Kebon Jeruk, Kota Adm. Jakarta Barat, Prop. DKI Jakarta
PT ANEKA WARNA SOLUSI MEDIA	Jl. Agung Timur XII, Blok N-2 No.12, Kel. Sunter Jaya, Kec. Tanjung Priok, Kota Adm. Jakarta Utara, Provinsi DKI Jakarta, Kode Pos: 14350
PT PERDANA JATIPUTRA	Jl. Bungur Besar No 89, Kemayoran, Desa/ Kelurahan Kemayoran, Kec Kemayoran, Kota Adm. Jakarta Pusat, Provinsi DKI, Jakarta, Kode Pos 10620
PT MANDIRI PERKASA DIGITAL KREASI	The Honey Lady Lt.2, Jl.Pluit Selatan Raya No.1, Penjaringan, Penjaringan, Jakarta Utara, DKI Jakarta
PT GLOBAL MULTIMEDIA TEKNOLOGI	Komplek Ruko Cempaka Mas Blok G No 11 Jl. Letjen Suprpto, Kel. Sumur Batu, Kec. Kemayoran , Kota Adm. Jakarta Pusat, Prop. DKI Jakarta
PT FOCUS INFOTAMA	Jl. Kaji No 22-F Petojo Utara Gambir, Desa/Kelurahan Petojo Utara, Kec Gambir, Kota Adm. Jakarta Pusat, Provinsi DKI Jakarta
PT ELANG MANDIRI SOLUSI	Pusat Niaga Roxy Mas Blok B 2 No. 9-10-11-12, Jalan K.H.Hasyim Ashari, Desa/Kelurahan Cideng, Kec. Gambir, Kota Adm. Jakarta Pusat, Provinsi DKI Jakarta
PT MITRA NIAGA GEMILANG	Komplek Ruko Wijaya Kusuma No. 6.A-B, Jl. Daan Mogot No. 48, Grogol Petamburan, Jakarta Barat, Kel. , Kec. , Kota Adm. Jakarta Barat, Prov. DKI Jakarta
PT MATAHARI MEGAH (ROBOTICS)	Jl.Raya Serang KM 8.5 RT001/001, Kadu Jaya, Curug, Tangerang, Banten 15810
PT HANDAL YESINDO SEJAHTERA (ROBOTICS)	Jl.Raya Kutisari 8-A, Siwalankerto, Wonocolo, Surabaya, Jawa Timur, 60291
PT PRIMA TEKNIK TRADA (ROBOTICS)	Kawasan Industri MM2100, Jl.Flores I Blok C1-18, Bekasi, Jawa Barat, 17520
PT INDUSTRIAL ROBOTIC AUTOMATION (ROBOTICS)	Jl.Raya Beringin No.32, Surabaya, Jawa Timur, 60218
PT SURYA SARANA DINAMIKA (ROBOTICS)	Komplek Mega Sunter B-40, Jalan Danau Sunter Selatan, Kel. Sunter Jaya, Kec. Tanjung Priok, Jakarta Utara, DKI Jakarta 14360, Indonesia
PT VORTEX ENERGY BATAM (ROBOTICS)	Jl. Kawasan Industri Tunas, Berlian, Kec. Batam Kota, Kota Batam, Kepulauan Riau 29444

EPSON AUTHORISED MASTER DEALER

City	Company Name
BALIKPAPAN	WIDYA WISESA
BANDUNG	PT ANEKA NIAGA GLOBAL
	PT SARANA SOLUSINDO SEJATI
	MEGACOM
	CV PRIMATECH VISINDO
	COMPUMAX
	PT LIEMARGA EKAPUTRA
	MANDIRI
	PT SARANA SOLUSINDO SEJATI
	CV WIJAYA MANDIRI
BANJARMASIN	CV DATACOM BANJARMASIN
	MULTI PRIMA
BATAM	CV MURACOM
	PT. TERANG INTI SEJAHTERA
BEKASI	PT XYZ GOPRINT INDONESIA
DENPASAR	CENTRALINDO COMPUTER
	CV AYU WIRA
JAKARTA	ARTA MUARA
	ASNI COMPUTER
	PT DIGITEC JAYA INDONESIA
	FLEXIPOS MITRA ABADI
	INDO BHAKTI UTAMA
	INTI DATA COMPUTER
	IS TECHNOLOGY
	MAKRO IT
	MEGATRONIX
	PT MILENIA MULTIVISI
	MULTI BERKAT COMPUTER
	PROSHOP
	PANCA CIPTA LESTARI
	PHOENIXINDO SARANA
	INFORMATIKA
	PLAZA COMP
	PT KHATULISTIWA JAYASAKTI
	ABADI (PROMUDIA)
	PT HARYA PILAR UTAMA SUKSES
	RIA DATA CENTRE
	SUPER COMPUTER
	TEGUH KOMPUTAMA
	VIN SOLUSINDO
	CV MULTICASA
	PT ANEKA WARNA INDAH
	CV X-COM MEDIA
	CENTRAL BARCODE SOLUSINDO
	DATA RETAIL SOLUTION
	ASCOM
	PT PASSWORD RITEL SISTEM
	INDONESIA
	PT SAMAFITRO
	MASTER MEDIA
	PT. FESTINO INDONESIA
	EGP COMPUTER
	CV MEDIA GRAFINDO

City	Company Name
JAKARTA	PT MULIA MANDIRI SUPPLY
	PT DARMAWAN OPTIMA
	PROJEKTOR
	PT MANDIRI ARTHA SOLUSI
	PT INTER DELTA TBK.
	PT ITKLIK INDONESIA
	UD JAYA UTAMA
	PT GRAHA SARANA INFOTAMA
	CV TOPSON INDONESIA
JAMBI	ELEVEN KOMPUTER
MAKASSAR	ARIEL COMPUTER
	CAHAYA SURYA COMPUTER
	UD VICTORIA
	SINAR LASER COMPUTER
	KOMETINDO
MALANG	PT FOCUS INFOTAMA
MANADO	MEGAKOMP
	CV HARMONI SUKSES MANDIRI
MEDAN	GOLDEN DRAGON COMPUTER
	ABC COMPUTER
	PT HARSA MASTERINDO
	TEKNOLOGI
PADANG	SINAR MULIA
	CV J-BROS
PALEMBANG	BOBBY COMPUTER
	PT MULTI DATA PALEMBANG
	MULTIKOM
PEKANBARU	CV CITRA KARYA MANDIRI
	PT DWIWIRA PUTRADINAMIKA
PONTIANAK	PT ANEKA MULTI SUKSES ABADI
	PT IT SOLUSINDO
	CV IRAMA VISION
SAMARINDA	LIDATA COMPUTER
	CV MITRA JAYA MANDIRI
SEMARANG	COMPUMART
	CV YESTOYA ABADI
	CV MEDIA INOVASI
SOLO	CV TUNAS ORCHID PRATAMA
	CV SINAR CITRA PRATAMA
SURABAYA	ABADI CIPTA KOMPUTER
	MESIN KASIR ONLINE
	HARAPAN JAYA COMPUTER
	CENTER
	KREASINDO CITRA NUSANTARA
	MULTI SARANA COMPUTER
	SURYA SATWIKA
	RAYA PERSADA
	CV WUJUD UNGGUL
	LOGIDATA
	CV CITRA SARANA SOLUSI
	CV. 7 DROPLET
TANGERANG	PT. LAYSANDER TECHNOLOGY
YOGYAKARTA	COMPUTA
	TOP DISTRIBUSI
	CV SINAR ABADI MULTIMEDIA
	PT PARON INDONESIA

EPSON AUTHORISED DEALER

City	Company Name
AMBON	CV TIGA SEJAHTERA
	CV CENTRAL ANGKASA PRATAMA
	CV THONBERS GEMILANG TEKNOLOGI
ATAMBUA	PT ROKAN INOVASI TEKNOLOGI
BAGAN BATU BALIKPAPAN	CV FULUSO COMPUTER
	CV GATRA SUKSES ABADI
	CV CIPTA JAYA
	CV SURYA JAYA SAKTI
	CV TIARAKOM
	CV BITRACOM INFORMATIKA
BANDA ACEH	CV ANGKASA PUTERA ABADI
	METRINDO.COM
	CV PUTRA SOLUSINDO COMPUTER
	CV REFILL CENTER
BANDAR LAMPUNG	CV VIRTUAL COM
	PT INTELINDO PUTRAPERDANA
BANDUNG	CV GLOBAL JAYA (BANDAR LAMPUNG)
	CV SINAR SUKMA WIJAYA
	CV SENTRA COMPUTER
	CV ALAM PRIMA KOMPUTER
	PT SUPERTech INTERNUSA
	TOTIN COM / TOKO TINTA
	CV FAEYZA GEMILANG ABADI
	PRIMA PARAHYANGAN
	KOMPUTER
	CV COMPUMAX MITRA SEJATI
	CV PILAR ABADI
	SINAR ABADI
	PT SIWA BANGUN PERSADA
	MEDIADATA
	PT SARANA SOLUSINDO SEJATI
	VISICOM
	CV PERSADA MANDIRI
	CV BERKAH KELOLA MANDIRI
	PT GIRSANG TEKNOLOGI SOLUSI
	PT VISUAL INDO PERKASA
CV SINAR BUDHI	
CV ANNISA MANDIRI	
CV MANDIRI BERKAT SEJAHTERA	
PT ABIRAMA KARYA TEKNIK	
PT AGRATAMA GLOBAL NIAGA	
PT INDOTEK BUANA KARYA	
PT MAKMUR EKA TEKNOLOGI	
CV MEDIATAMA COMPUTINDO	
CV ALPHA GAMING INDONESIA	
CV GOLDEN MITRA PRATAMA	
TOKO BUKU MERAUKE	
BANGGAI LAUT	CV BAWA KARAENG COMP
	CV HAY JAYA MANDIRI
BANJAR	BM COMPUTER
BANJAR BARU	CV TWIN GROUP
BANJARMASIN	CV NUSANTARA JAYA
	CV BERLIN KOMPUTERINDO
	CV DATACOM
	CV ANEKA COMPUTER
	CV INFO TECHNIC
	CV BANDUNG USAHA JAYA
	CV MITRA SOLUTION

City	Company Name	
BANTAENG	DELTA COMPUTER	
BANYUWANGI	CV BINA USAHA	
	CV SENTRA DINAMIKA	
	CV SINAR KENCANA	
BARABAI	CV HIDAYAH TECHNOLOGY	
BATAM	PT INK SHOP CENTER	
	PRO COMPUTER	
	IT STORE COM	
	PT AZTECH KARYA MANDIRI	
	PT KARYA MURA KOMPUTER	
	PT AIR MAS BATAM JAYA	
	CV TEKNOLOGI BATAM	
	SOLUSINDO	
	PT MULIA MAKMUR LESTARI	
	PT TEKNOLOGI MULTIBISNIS	
	MASTERINDO	
BATANG	CV KARYA CIPTA MANDIRI	
BATU LICIN	CV SMART JAYA TECH	
	TOKO ANDHIKA	
BATURAJA	CV JASU SRI WAHYU	
	CV COMPUTERINDO BERKAT SEJAHTERA	
BAU BAU BEKASI	CV YANTI COM	
	PT XYZ GOPRINT INDONESIA	
	PT WIRA NET SOLUSI	
	PT CYGNUS CYRUS CEMERLANG	
BENGKALIS	CV WAHANA DISTRIBUSINDO	
	INDONESIA	
	CV INTEL KOMPUTER	
	CV DWI MANDIRI	
	CV TEKNINDO PERKASA	
	BENGGAYANG	CV BANLIE COMPUTING
		CV HARINDO UTAMA
	BENGGULU	CV BIRU TEKNOLOGI
		MULTIMEDIA
		CV WIRA JAYA KOMPUTER
		PT MEGA INTI TELAGA
	BERAU	CV MEDIA JAYA KOMPUTER
		CV PERDANA MAKMUR JAYA
		PT METRO RAYA INTIPRIMA
		CV ROBINSON KOMPUTER
		G KOMPUTER
	BIAK BIMA	CV HANJAYA GEMILANG
CV TIGA NUSA COMPUTER		
BINJAI	SENTRAL MUSLIM	
	ZIP COMPUTER	
BIREUEN	ENTER COMPUTER BINJAI	
BITUNG	HIJRAH COMPUTER	
BLITAR	SMART COMPUTER BITUNG	
BLORA	CV SENTRA MEDIA	
	CV MITRA PRATAMA	
BOGOR	KOMPUTINDO	
	PT ZOOM INFOTEK TELESINDO	
	CV MEGA PERKASA	
BOJONEGORO	CV POJOKS SUMBER BERKAT	
	CV ASTON CAHAYA GEMILANG	
	CV HITECH COM	
	CV INDO SARANA MAKMUR	
BONDOWOSO	CV FASTECH MANDIRI	
	CV CAHAYA BANGKIT MAKMUR	
BONE	CV BINTANG EMPAT PERKASA	
	KURNIA COMPUTER BONE	
	CV SURYA INDAH COMPUTER	

EPSON AUTHORISED DEALER

City	Company Name
BONTANG	UD BINTANG PERDANA PRIMA
BOYOLALI	CV XP COMPUTER MEDIATAMA CV DIMENSI TIGA CV TERA
BUKIT TINGGI	PT CENTRAL MULTI COMPUTER CV VGA KREASI SYSTEM
BULUKUMBA	CV MEDIA KOMPUTER
BULUNGAN	TOKO GRACIAS
CANJUR	PT MULIA SARANA ABADI
CIAMIS	CV MEDIA INFORMATIKA COMPUTER CIAMIS PT ANUGRAH INTI MAKMUR (ANUGERAH COMPUTER)
CIANJUR	CV MITRA JAYA KOMPUTINDO CV GEMILANG JAYA
CILACAP	BASS COMPUTER CV KARTIKA DWIGUNA CV PUTRI KITA KOMPUTAMA
CIMAHI	CV NISCAYA BERKAH
CIREBON	CV MITRA INDEXINDO PRATAMA CV MANJAYA KOMPUTER ASIA COMPUTER CV ANEKA NIAGA SENTOSA PT JAYA PRATAMA COMPUTINDO CV SABANG BERKAH KOMPUTAMA CV ALFA TEKNOLOG DIGITAL CV SINAR TERANG CV INDO AURUM CV POLARIS KOMPUTAMA CV SANGRIA MANDIRI COMMUNICA PT SATYA KENCANA TEKNOLOGI
DEMAK	PRIMA KOMPUTER
DENPASAR	ASTIKOM CV BALI TECHNO GROSIR COMPUTER PT BALI SATU COMPUTER ADI RAYA KOMPUTER PT ARTHA BALI COMPUTINDO CV GLOBAL JAYA SEJAHTERA CV INDOTECH PT BALI YONI SAGUNA PT MASTERDATA BALI CV Z4COMP CV BALI IT SOLUSI CV ESA JAYA
DEPOK	PT GIAN TEKNOKINDO SOLUSI
DUMAI	CV SOLUTION TECHNOLOGY CV DELTA TEKNOLOGI CORPORINDO PT MAESTRO MEDIA TEKNOLOGI
FLORES	CV ERA CIPTA RAYA
GARUT	PT MAKMUR ESENSI INDOSETIA PT GOLDEN HASANAH INDONESIA CV SEHATI INDO DUA
GORONTALO	CV GORONTALO COMPUTER CV TAMPA PRINTER PT SQUARE GORONTALO ISTANA DISC COMPUTER PT REJEKI MITRA SEJAHTERA

City	Company Name
GORONTALO	CV CIPTA KENCANA SEJAHTERA CV SPECTRUM MEDIATAMA CV MUFIDAH
GRESIK	CV TERACOM CIPTA PERSADA
GROGOT	C-PRINT
HALMAHERA SELATAN	CV LA TANSI COPIER
HULU SUNGAI UTARA	CV YULIDA
INDRAGIRI HILIR	CV AKASIA TSURAYYA EDY COMPUTER
INDRAMAYU	CV PERSONAL COMPUTER
JAKARTA	PT CEMERLANG ABADI COMPUTINDO PT BINTANG RAYA KOMPUTAMA CV DUNIA MAS COMPUTER CV MULTI KARYA SUKSES PT DWI TUNGGAL SEJAHTERA PT EXCELINDO SEJAHTERA PT INTEGRA INFOTEK SOLUSITAMA CV INTI RAYA UTAMA PT IS PRATAMA ABADI PT SINGA MULIA ABADI PT SIS KENCANA MAS CV METAMA COMINDO NUSA PANEN RAYA PLAZA COMPUTER PT PHOENIXINDO SUKSES PERKASA CV TUAIAN BERKAT CV VE NUSANTARA PT DATAPOINT PT ANGEL SOLUSI TECHNOLOGY PRIMAX COMPUTER CV LIGA INTI RAYA PT ARMINDO MANDIRI CV NATHAN SUKSES MAJU JAYA CV DUTAMETRIX JAYA PERKASA PT CIPTA MITRA SOLUSINDO SUN JAYA COMPUTER SETIA JAYA COMPUTER CV BERKAH GLOBAL PERSADA DUTA 1 (ONE) SANGKAKALA GOLDEN SWAN COMPUTER PT BASIS DWI NIAGA PT MILENIA MULTIVISI PT MEGATRONIX MITRANIAGA PT DIGITEC JAYA INDONESIA PT SOLUDEA KARYA INDONESIA PT KALLISTA KOMPUTER TEKNOLOGI PT SUKSES KOMPUTINDO ABADI PT METEOR INDORETAIL COMPUTAMA PT TEKNO MANDIRI ABADI PT AGRES INFO TEKNOLOGI UD JAYA MAKMUR CV EASY MITRA PT TEGUH KOMPUTAMA PT PELITA CAHAYA TEKNOLOGI CV JAYA MANDIRI

EPSON AUTHORISED DEALER

City	Company Name	
JAKARTA	PT KREASI Cipta Computindo	
	PT WIDJOYO MITRA ABADI	
	PT FLEXIPOS MITRA ABADI	
	PT ERA SUPPLIES INDONESIA	
	PT GRAMEDIA ASRI MEDIA	
	PT XTRODATA PERSADA INDONESIA	
	UD CAHAYA FORTUNA	
	PT PIANO INTEL KOMPUTER	
	JAMBI	CV ANDIKA SURAYA KOMPUTER
		PT VICTORY TECHNOLOGY ABADI
JAYAPURA	PT MASTERDATA JAMBI	
	CV ALVA MEDIA KOMPUTINDO (JAYAPURA)	
	CV MASTER COMPUTER	
JEMBER	CV ABEKOM JAYA ABADI	
	PT BITCOM	
	CV ELANG INDONESIA	
	PT DUTA SAMUDRA PASIFIK	
JEPARA	PT SENYUM MEDIA UTAMA	
	CV ASIA JAYA	
	CV SAFRINDO PERKASA	
JOMBANG	CV DWI PERKASA (SEMARANG COMPUTER)	
	CV MITRA DATA BERJAYA	
KAB BANDUNG	CV SIDODADI KOMPUTER	
	CV Sinar Mandiri Solution	
KANDANGAN	CV HITRO	
KAPUAS HULU	CV MITRA KOMPUTER	
KARANGANYAR	ELGIN COMPUTER	
	CV CAHAYA PUTRA MANDIRI	
KARAWANG	PRIMA COMPUTER (PC)	
KAYONG UTARA	CV MEGATAMA SOLUSINDO	
	CV PRISMA UTAMA	
	CV MITRA KS UTAMA	
KEBUMEN	CV BERKAH LAPAK UTAMA	
	CV VISUAL	
	CV FM. 90	
KEDIRI	CV MITRA JAYA	
	CV RAHARJA SEJAHTERA	
KENDAL	CV MAJU MAPAN ABADI	
	AL BUMI IT STORE	
	CV KREASI COMPUTER	
KENDARI	CV TIGA TUJUH TEKNOLOGI KOMPUTER	
	CV MENTARI COMPUTINDO	
	RAKA MEDIATECH	
	UD KALAM HIDUP	
	CV RC COMPUTER	
	CV ANUGERAH DAMAI	
	SEJAHTERA	
	CV TUMAKA	
	KETAPANG	CV METRO IT
		CV R COM
KISARAN	CV F3I	
KLATEN	INTAN COMPUTER	
	AS COMPUTER	
	SIGMA COMPUTER	
	CV RAGAM PERSADA	
	PT SENTRA KRIYA EDUKASI	

City	Company Name
KOTAMOBAGU	CV STARINDO COMPUTAMA
	CV CARPERCOM
	CV ACOMP
	CV RHAVA COMPUTINDO
KOTAWARINGIN BARAT	CV ANUGRAH Cipta Mandiri
KOTAWARINGIN TIMUR	CV PRIMA UTAMA
KUALA SIMPANG	LOGICA KREASI
KUANTAN	CV GLOBAL KOMPUTER TELUK KUANTAN
SINGINGI	KUANTAN
KUBU RAYA	TOKO WAYCOM
	SINAR JAYA COMPUTER
KUDUS	CV SALAM JAYA KOMPUTINDO
	PT GLOBAL DATA NIAGA TBK
	CV EGYD
KUNINGAN KUPANG	PT BINTANG TIMOR SUKSES SEJAHTERA
	CV DUTA MULTI COMPUTER
	CV PERDANA GLOBALINDO
	CV KHARISMA COMPUTER
	PT UNISTAR SARANA JAYA
	CV ALFA GRACE
	CV DELTA SUKSES
	ERICK VON GOTTLIEB COMPUTER
	UD DUO HATI BERSAUDARA
	CV KLINIK KOMPUTER
CV SENTRAL SOLUSI SEJAHTERA	
KUTAI KARTANEGARA	CV GLOBAL GROUP
	JEMMY COMPUTER
	CV WANGI RATANA INFORMATIKA
KUTAI TIMUR LAHAT	RAJA COMPUTER
	CV MY COMPUTER DAN ELEKTRONIK
LAMANDAU	CV HAMBA PUTRA
LAMONGAN	CV EKO COMPUTER
LAMPUNG	PT TIGA PENDEKAR SEJAHTERA
LEBAK	CV KURNIA DIGITAL SOLUSINDO
LOMBOK	NUSA PERDANA
LOMBOK TIMUR	CV MARSYA COMPUTER
	CV DELTA
LUBUK LINGGAU	CV SIGMA KOMPUTER
	ARTECH KOMPUTER
LUBUK PAKAM LUMAJANG	ICON COMPUTER
	CV CITRA ABADI
	CV PASTI JAYA
LWUWU TIMUR	CV LAB PERSADA
	CV MALILI TEKNO
	CV MALEO KOMPUTER
	CV BRAGA SUKSES BERSAUDARA
	CV JAYA RAYA KOMPUTINDO
LWUWU BANGGAI	TOKO SMART COMPUTER
	CV GLOBAL ICHITEKNO
MADIUN	CV BIMA DIANIMAS NUSANTARA
	CV MAJU BERSAMA
	CV ISTANA KOMPUTER MANDIRI
MADURA	CV BEJREH GUNAH
	CV TUNGGAL OPTI PERSADA
	CV MICRO COMPUTER
	CV REX COMPUTER

EPSON AUTHORISED DEALER

City	Company Name	
MAKASSAR	CV SMART MEDIA CEMERLANG	
	CV MAKASSAR PRINT	
	LAKSANA ELANG	
	CV CAHAYA SURYA KOMPUTER	
	PT HND KOMPUTAMA	
	PT MAHADEWA TEKNOLOGI	
	KOMPUTINDO	
	PT KOMETINDO KOMPUTAMA	
	PT MUGEN MULTI DISTRIBUSI	
	PT RAMA PRIMAVERA	
	PT SURYA ANUGRAH	
	KOMPUTINDO	
	PT CAHAYA INDOKOM	
	CV ELEXTA	
	PT SONIC KOMPUTER	
	INDONESIA	
	CV LADANG TANAH EMAS	
	CV LASER COMPUTINDO	
	CV CIPTA ZAQI PERSADA	
	PT MEGARICH MITRA JAYA	
	CV CACA TECHNO INDONESIA	
	PT VICTORIA JAYA KOMPUTAMA	
	MANAR COMPUTER	
	BUMI MAKMUR KOMPUTER	
	CV ALVATECH	
	PT KEYLA WILSON ABADI	
	CV PROTON SUKSES BERSAMA	
	PT PROTOTIN SINERGI	
	INDONESIA	
	TOKO SUKSES JAYA	
	CV MILAN JAYA KOMPUTAMA	
	PT ARIEL CREATIVE ELEVATION	
	CV ECOMPUTEX DISTRIBUSI	
MALANG	GALAXY SOLUSINDO	
	CV IJEN COMPUTER	
	CV SEMESTA GROUP	
	CV ESA MEDCO TECHNOLOGY	
	HARTONO 2 COMPUTER	
MALINAU	CV IN MULTIMEDIA	
	NGALAM COMPUTER	
	CV GREEN YUFID GROUP	
	MALINAU	CV CLAVIE
		MAMUJU
IFAH KOMPUTER		
MANADO	CV BINTANG LIBRA KOMPUTER	
	CV LEVEL DUA PUTRI	
	CV INTERTECH	
	CV TERMINAL KARYA MANDIRI	
	MEDIA PRIMA	
	CENTRAL GAME	
	NEUTRON COMPUTER	
	CV REMPAN MANADO	
	ISTANA COMPUTER	
	ITECH SERVICE INDONESIA	
MANOKWARI	CV MAKARIOS	
	MATARAM	CV KABAR GEMBIRA
CV REVAYAH SUMBER BERKAT		
CV MATRIX COMPUTER		
CV SATU SATU JAYA		
CV CATUR WARGA COMPUTER		
CV RINJANI MANDIRI		
SEJAHTERA		
CV DUNIA ALAT TULIS LOMBOK		

City	Company Name	
MEDAN	PT MIKROTEK KOMPUTINDO	
	REZEKI JAYA KOMPUTER	
	SURE COM	
	PT ADHIMUKTI KARYA BERSAMA	
	PT LOGIKREASI UTAMA	
	MEDIA COM	
	SUPERTECH COM	
	CONTEC JAYA	
	CV CITRALOKA	
	PT HOKI ABADI SENTOSA	
	CV SIMONE COMINDO	
	MITRA INTERMEDIA	
	OK COMPUTER	
	CV MANDIRI SUCCESS JAYA	
	BENUA JAYA COMPUTER	
	CV HERO KOMPUTER	
	CV GEMILANG JAYA PERKASA	
	PT SUMBER UTAMA NUSANTARA	
	PT DAYAMEGA PRATAMA	
	CV JAYA ABADI MEGAH	
	CV SAMA SIDE	
	PT PRIMAJAYA MULTI	
	TECHNOLOGY	
	CV HIDUP BARU TEKNOLOGI	
	CV ABC ASIA	
	WAROENG IT	
	PT SARANA TEKNIK INTEGRASI	
PT UTAMA JAYA KOMPUTER		
PT KOMDISC SUKSES		
MELAWI	TEKNOLOGI	
	MERAUKE	CV PADI
CV STARCOM		
METRO	PT INSAN MITRA TEKNOLOGI	
	CV ADA COM	
MEULABOH	CV MULTI MEDIA	
	CV INDICOM	
MOJOKERTO	IT CORNER	
	ANTASARI COMPUTER	
	CV TOP SELULER	
MUARA BUNGO	CV SINAR KARUNIA SULUNG	
	PT MITRA KOMPUTER BUNGO	
MUNTILAN	CV AMINOS COMPUTER	
	NABIRE	CV ASIA CENTRAL COMPUTER
ARYA PANDAWA		
OGAN	CV PUNCAK MULIA	
	KOMERING ULU	CV SURYA ABADI
PACITAN		CV MITRA MULYA KOMPUTER
	PADANG	PT SEMANGAT BERKAT JAYA
CV VENES JAYA		
PT HEDIMAN KHARISMA		
MANDIRI		
PT PANEN JAYA SENTOSA		
CV MAX-INDO		
CV MITRA COM		
CV BE TECH		
PAGAR ALAM		CV FITRA PRATAMA
		PAINAN
PALANGKARAYA	PT UNIVERSAL SELULER	
	COMPUTINDO	
CV MULTI JAYA ABADI		

EPSON AUTHORISED DEALER

City	Company Name	
PALEMBANG	CV MITRA PERSADA KOMPUTER	
	CV BOBBY PUTRA PRATAMA	
	CV INTI MANDIRI PERMATA	
	CV MULIA JAYA	
	PT MULTI DATA PALEMBANG	
	SPIDER COMPUTER	
	CV ZOOM IT SOLUTION	
	CV RIA KENCANA UNGU	
	PT PANCA ABADI PERKASA	
	CV ANEKA PAPERINDO	
	PT BHINNEKA SEJATI INDONESIA	
	CV SEMANGAT BERSAMA	
	PALOPO	CV ARUNA MULTI COMPUTER
		CV GERHANA MEDIA PERKASA
PALU	CV DREAM UTAMA GROUP	
	UD METEOR COMPUTER	
	SINAR MAKMUR COMPUTER (SMC)	
	CV LIBRA COM	
	CV LIMA NET	
	PT ALYA PRIMA VERA	
	CV SHUNU ARTHA CEMERLANG	
	CV ALEXANDRA	
	CV LAGUNA KONS	
	CV GLOBAL JAYA (PALU)	
	CV KURNIA BARU	
	PAMEKASAN	SARANA INTI DATA
		CV MEGA DUTA COMPUTINDO
	PANGKAL PINANG	CV SENTRA KOMPUTER
	CV WELLS PRATAMA MANDIRI	
	CV DEDE COMPUTER	
	CV DUTA BINTANG UTAMA	
PAPUA	CV TONAWI TRIGAN PAPUA	
PARIAMAN	UD SURYA KOMPUTER	
PARIGI	CV PRIMA COMPUTER	
PARINGIN	CV DATA GARUDA BLG	
PASURUAN	CV ANEKA SARANA COMPUTER	
	CV KARISMA JAYA ABADI	
	CV MITRA UTAMA	
	CV YAP COM	
PATI	MICRO PRINTER	
	CV PRIBUMI JAYA KOMPUTAMA	
	CV PUTRA MANDIRI	
PAYAKUMBUH	PT INDO ALBANI TEKNOLOGI	
PEKALONGAN	CV MITRA GROUP	
	CV MULTINET KOMPUTER	
PEKANBARU	CV OMEGA JAYA SEJAHTERA	
	CV REYAN COMPUTER	
	CV SEJAHTERA IT SOLUTION	
	CV TEKNO KOMPUTER	
	CV COMPUTER SQUARE	
	TOKO UTAMA KOMPUTER	
	CV BITCOM NUSANTARA ELEKTRONIK	
	CV MEGA KOMPUTAMA PERKASA	
	CV BEST COMPUTER	
	CV IT JAYA PRATAMA	
	CV JAYA MITRA ABADI	
	NEW EDYCOM	
	CV MULTI MEDIA KOMPUTER	

City	Company Name
PEKANBARU	PT TOBA MAKMUR PERKASA
	CV MULIA JAYA PRATAMA
	PT PROMEDIA SUKSES BERSAMA
PEMALANG	CV IRAMA PUTRA MANDIRI
PEMATANG SIANTAR	CV GABE INDO PERKASA
	KRAKATAU JAYA
PINRANG	MANRAPI COMPUTER
POLEWALI MANDAR	KARTIKA CELL & COM
	GALERY COMPUTER
	SINAR KOMPUTER
PONOROGO	CV REVOLUTION PRATAMA
PONTIANAK	CV ZONA MULTIMEDIA
	CV COMCOW CENTRANUSA
	DUTA COMPUTER
	PT DATACOM DIGITAL
	PT IT SOLUSINDO
	CV MENARA SQUARE
	PT ANEKA MULTI SUKSES ABADI
	KURU KOMPUTINDO (KURAKOM)
	CV USAHA JAYA ABADI
	CV ARTHA JAYA PRIMA
	PT CIPTA SARANA INTEGRASI
	CV DATA BASIS TECHNOLOGY
	CV ASTERINDO
	CV ELITE KOMPUTINDO
	PEGASUS COMPUTER (PONTIANAK)
	CV MENARA GRUP
	CV JAWARA GRUP COMPUTINDO
	CV CENTRAL INDO SOLUTION
	CV DIVINE COMPUTER
	CV CIPTA WISESA
	PRABUMULIH
PRINGSEWU	CV GLOBAL COMPUTER
PROBOLINGGO	CV MEDIA TEHNIK COMPUTINDO
	CV RINJAYA ELECTRINDO
	WIJAYA COMPUTER
	CV JONAS SEJAHTERA TEKNOLOGI
	CV YOTTA TECH
PURBALINGGA	CV YOTTA TECH
PURWAKARTA	CV FASTABIC
	CV TRIPIO COMPUTER
PURWOKERTO	CV SISWOYO
	PT ALFA GIG
PURWOREJO	CV MEDIA TEKNOLOGI
	CV MULTI BERKAH SOLUSI
SALATIGA	PT ASTON PRINTER INDONESIA
	CV SMART
SAMARINDA	DJONIE PRINT
	PT SALIM SURYA PHONE
	CV MITRA JAYA MANDIRI
	PT HARTORA KANONDATIM PRADANA
	CV BINTANG JAYA KOMPUTER
	PERDANA JAYA COMPUTER
	CV DUTA SARANA COMPUTINDO
	CV PRINTERKU JAYA SEJAHTERA
	CV MASTERPIECE
	CV PREGA LESTARI
	BAZZAR COMPUTER

EPSON AUTHORISED DEALER

City	Company Name
SAMARINDA	CV ARINGO RAYA
	CV JAVA COMPUTER SAMARINDA
	CV TBOX PRIMA PERKASA
SAMBAS	PT NUANSA DHARMA CIPTA
	PEDOMAN COMPUTER
SAMPIT	CV MEDIA COMPUTER
	CV DATA MENTAYA
SANGGAU	METTA YOUTH DIGITAL STUDIO
	TOKO KINGDOM COMPUTER
SAROLANGUN	CV ZOOM
	CV VAN'S COMPUTER
SEKADAU	DOKTER KOMPUTER
	NEW GLORIA COMPUTER (NGC)
SEMARANG	CV NEO COMPUTER
	PT HETERO NIAGA GLOBAL
	PT HARRISMA PRATAMAJAYA
	CV RAJA PRINT SOLUTION
	UD PIXEL
	CV YESTOYA ABADI
	PT INFOKOM PUTRA KENCANA
	CV TRINITY GROUP
	CV KARYA HIDUP MULYA
	CV BUMI RAYA INDONESIA
SENGKANG	ARIEL IT COMPUTER
	PT ARTHA INDONESIA
SERANG	TEKNOLOGI
	CV BERKAH JAYA COMPUTINDO
SIBOLGA	CV MODERN COMPUTER
	CV MATAHARI MAKMUR
SIDOARJO	PT INTERMEDIA COMPUTER
	INDONESIA
SIGLI	CV RAINBOW NUSANTARA
	CV MARYSA COM
SINGKAWANG	ORION COMPUTER
	CV CENTRAL KOM
SINJAI	CV MEDIA SARANA
	CV AMALIA UTAMA KOMPUTER
SINTANG	CV GLORIA COMPUTER
	CV SAINTS COMPUTER
SITUBONDO	MITRA COMPUTER
	UD SITCOMP
SLEMAN	KAIROS COMPUTER
	CV INDOPRINT SEJAHTERA
SOLO	ABADI
	PT ANDALAS SURYA GEMILANG
	PT SADAR JAYA MANDIRI
	PT MANXI IMAGE PERKASA
	CV PRIMA MITRA ABADI
SORONG	CV RISC COMPUTER
	CV PUTERA KREASINDO
	TOHO KOMPUTER
	CV AORA SUMBER SOLUSINDO
STABAT	VISTA COMPUTER (VC)
	PUTRI COM
SUBANG	CV KANABA SEJAHTERA
	CV MS COMPUTER
SUKABUMI	CV RNY COMPUTER AND
	COMMUNICATION
SUKAMARA	CV SAHABAT KOMPUTER DAN
	ELEKTRONIK
SUKOHARJO	AKASIA KOMPUTER

City	Company Name
SUMBAWA	CV RISKY MEDIA COMPUTER
	BESAR
SURABAYA	CV BERKAT ABADI COMPUTINDO
	PT ASIAMAS TEKNOLOGI
	GROSIRIA
	PT LOGI DATA TEKNOLOGI
	PT BERKAT SUBUR LESTARI
	PT CAHAYA INTI PRIMA
	ARRABON COMPUTER
	CV DB KLIK
	GAJAH MADA KOMPUTER
	PT METROKOM JAYA
	CV ALFAPRINTER PERDANA
	MANDIRI
	PLATINUM COLOUR
	SKY PRINTING
	PT SUN DIGITAL TEKNOLOGI
	INDONESIA
	CV TRIJAYA SUKSES MANDIRI
	PT KREASINDO CIPTA
	NUSANTARA
	GOLD INK CENTER
	PT SURYA ARTHA KOMPUTAMA
	CV INDOCOM SUKSES MAKMUR
	CV CAHAYA ABADI PERSADA
	PT ANUGRAH TUMBUH
	KHARUNIA
	CV WIJAYA TECHNOLOGY
	INDONESIA
	CV KARYA SATYA TEKNOLOGI
	AIPEL COMPUTER
	PT NUSAJAYA SEJAHTERA
	COMPUTER
PT SURYA CAKRA	
CV KARYA MAJU PERDANA	
CV DYNAMEDIA SOLUSI	
TEKNOLOGI	
CV SELALU ADA SOLUSI	
CV DUTA SARANA SEJAHTERA	
CV CELLCOM ID LENOVO STORE	
CV SINAR SAMUDRA	
PT SURYA SAKTI TEKNOLOGI	
INDONESIA	
CV SURYA PREMIUM	
CV BERIN INFORMATIKA	
PT DORAN SUKSES INDONESIA	
CV NOAH SEJAHTERA ABADI	
PT SERUNI INDAH SEMESTA	
CV ANDRO TEKNOLOGI	
CV MITRA MANDIRI ABADI	
CV PANEN JAYA ABADI	
PT HATSONSURYA ELECTRIC	
PT DAMAI SEJAHTERA ABADI	
MVP KOMPUTER	
TAKENGRON	PT HARTA JAYA SENTOSA
	BERSAUDARA
	PT THEA THEO STATIONARY
	PT PIRAMIDA INTI PERSADA
	PT MITRA MARGA SEJAHTERA
	PT DUTA TEKNOLOGI
	NUSANTARA
PT PUTRI INTI SUKSES	

EPSON AUTHORISED DEALER

City	Company Name
TANGERANG	PT JUNG JAYA BERDIKARI
	CV FERI PERMANA OGAN
	PT META TEKNO ASIA
TANGERANG SELATAN	CV MITRA SUKSES MANDIRI
TANJUNG	IRWAN COMPUTER
TANJUNG BALAI	TECHNO INFINITY
KARIMUN	
TANJUNG MORAWA	PT BINTANG TEKNOLOGI
TANJUNG PANDAN	SEMPURNA
TANJUNG PINANG	CV MULTI SARANA UTAMA
	TOKO FORCE
	INFOTECH COMPUTER
	GLOBAL IT
	PT DIGITAL MANDIRI JAYA
	STANDARD COMPUTER
	CV LOGIN KOMPUTINDO
TARAKAN	CV PLUS-PLUS
	ADIN PRINTER
TASIKMALAYA	CV SEMESTA KOMPUTAMA
	CV MEGAH GLORY
TEBING TINGGI	MITRA UTAMA KOMPUTER
	PEGASUS COMPUTER
	CV ANUGRAH ABADI PRATAMA
TEGAL	CV INDO KOMPUTER
	PT PUTRAPUTRA LANGGENG JAYA
	CV NEW LIFE COMPUTER
	CV ANUGERAH DAFA LESTARI
	CV TRENDS COMPUTECH
	CV CITA ADI KARYA
	CV REPUBLIK ADI JAYA
	GUDANG KOMPUTER
TEMBILAHAN	CV MATRIX PERKASA
TERNATE	CV GIGA COM
	PT DATAGRID MAESTRO TEKNO
	CV MARS JAYA
TIMIKA	CV ITHSAN INFOTIKA
	CV INDOPRIMA JAYA
	GALILEA KOMPUTER PAPUA
	CV MEGATAMA JAYA SENTOSA

City	Company Name
TORAJA	CV MULTICOM ANUGRAH PERSADA
	BALBOD COMPUTER
	CV POWER DIGITAL COMPUTER
TUBAN	MITRA SEJATI KOMPUTER
	CV VICTORY INDO PRATAMA
TULUNGAGUNG	RADJA COMPUTER
	MAXINDO COMPUTER
	CV LAUTAN BERKAT ABADI
	CV DHARMA INTI NUSA
WAINGAPU	CV GLOBAL TEKNIK
WONOGIRI	CV RAYA SOLUSINDO
	CV BLEZA OPTIMA
WONOSOBO	CV VARIA BERKAH MANDIRI
YOGYAKARTA	PRIMA COMPUTER
	CV JAYA UTAMA SUKSES
	CV KANA
	CHANNEL COMPUTER
	RAJA INK YOGYAKARTA
	PT HARRISMA BUWANA JAYA
	CV SUKSES SEJATI COMPUTAMA
	CV ANNISA COMPUTER
	PT SETIA HARAPAN COMPUTER
	CV FAHANA CITRA
	CV AIZZA
	CV BELLA CAHYA
	PT DINAMIKA PERKASA JAYA
	CV SEMESTA JAYA COMPUTINDO
	CV STAR MEDIA COMPUTAMA
	WARA COMPUTER
	PT WISNO GRAHAKOM
	CV METROCOM
	CV ALAM SEJAHTERA JAYA
	COMPUTER
	CV TUJUH ENAM COMPUTER
	CV SEMITRA ADA SOLUSI

EPSON

ENGINEERED FOR



At Epson, we create efficient, compact and precise technologies to reduce resources for sustainable future.

We engineer for good. We engineer for you.



Scan here
for information

epson.co.id



www.epson.co.id/ecotank

INKTANK PRINTER



ECO

INKTANK PRINTER

MENGAPA MEMILIH ECOTANK ?

Printhead seri EcoTank dengan teknologi *Micro Piezo* merupakan teknologi eksklusif dari Epson. Dirancang bekerja andal dan tahan lama. *Printhead Micro Piezo* memungkinkan pencetakan pada berbagai jenis media. Adapula fitur cetak cepat, pemrosesan gambar, sistem tinta, tinta, pemindahan kertas dengan sangat akurat dan mekanisme lainnya.

PrecisionCore

PrecisionCore adalah teknologi printhead yang berupa lapisan tipis unik *piezo* (TFP) yang memadukan teknologi komponen superior dengan teknologi fabrikasi *Micro-Electro-Mechanical-System (MEMS)* yang berpresisi tinggi. Hasilnya adalah kecepatan cetak dan mutu gambar yang tinggi untuk pemakaian di berbagai kegiatan usaha dan industri.

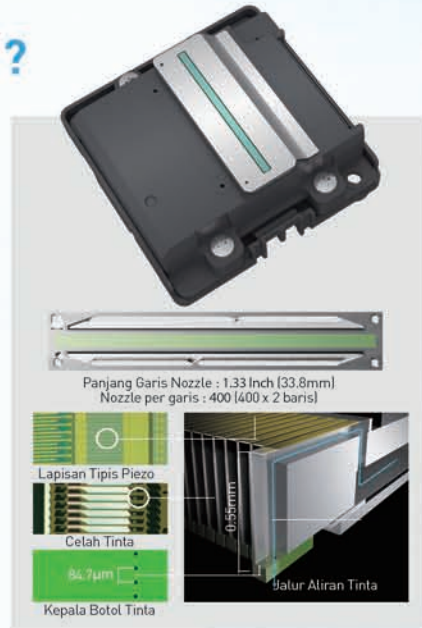

BOTOL TINTA UNIK YANG DAPAT BERHENTI OTOMATIS DAN TANGKI TINTA MUDAH DIISI ULANG



Tangki tinta menghadap ke depan untuk mempermudah pengisian ulang tinta.



Tidak akan ada kesalahan pengisian ulang tinta karena setiap desain saluran memiliki bentuk berbeda.



Tidak tumpah.

INKTANK PRINTER

Printer Warna Printer Multifungsi untuk Perkantoran / SOHO

INKTANK PRINTER



L6290

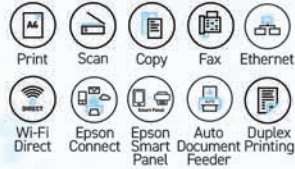

- Printer Type** Print, Scan, Copy, Fax with ADF
Technology PrecisionCore™ Printhead
Ink 4 Colours Epson Genuine Ink Bottle
Print Resolution 4,800 x 1,200 dpi
(with Variable-Sized Droplet Technology)
Print Speed Up to 33 ppm / 20 ppm
Copy Resolution 600 x 600 dpi
Copy Speed Up to 11 ipm / 5.5 ppm
Scan Resolution 1,200 x 2,400 dpi
Scan Speed Monochrome 200 dpi: 12 sec, ADF ; 5.0 ipm
Colour 200 dpi: 27 sec, ADF ; 5.0 ipm
Connectivity USB 2.0, Ethernet, Wi-Fi IEEE 802.11b/g/n,
Wi-Fi Direct
Epson Connect Epson iPrint, Email Print, Remote Print Driver,
Scan to Cloud
Other Mobile Solution Apple AirPrint, Mopria Print Service,
Epson Smart Panel
Warranty 2 years or 50,000 pages
Ink Model 001 (B – Pigment, CMY – Dye)
Maintenance Box C13T04D100



L6270

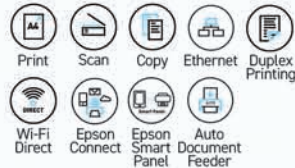

- Printer Type** Print, Scan, Copy with ADF
Technology PrecisionCore™ Printhead
Ink 4 Colours Epson Genuine Ink Bottle
Print Resolution 4,800 x 1,200 dpi
(with Variable-Sized Droplet Technology)
Print Speed Up to 33 ppm / 20 ppm
Copy Resolution 600 x 600 dpi
Copy Speed Up to 11 ipm / 5.5 ppm
Scan Resolution 1,200 x 2,400 dpi
Scan Speed Monochrome 200 dpi - Flatbed : 12 sec / ADF ;
5.0 ipm
Colour 200 dpi - Flatbed : 27 sec, ADF : 5.0 ipm
Connectivity USB 2.0, Ethernet, Wi-Fi IEEE 802.11b/g/n,
Wi-Fi Direct
Epson Connect Epson iPrint, Email Print, Remote Print Driver,
Scan to Cloud
Other Mobile Solution Apple AirPrint, Mopria Print Service,
Epson Smart Panel
Warranty 2 years or 50,000 pages
Ink Model 001 (B – Pigment, CMY – Dye)
Maintenance Box C13T04D100

INKTANK PRINTER

Printer Warna Printer Multifungsi untuk Perkantoran / SOHO

L6260

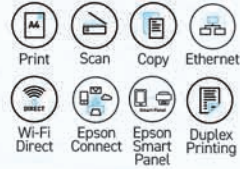

- Printer Type** Print, Scan, Copy
- Technology** PrecisionCore™ Printhead
- Ink** 4 Colours Epson Genuine Ink Bottle
- Print Resolution** 4,800 x 1,200 dpi (with Variable-Sized Droplet Technology)
- Print Speed** Up to 33 ppm / 20 ppm
- Copy Resolution** 600 x 600 dpi
- Copy Speed** Up to 11 ipm / 5.5 ppm
- Scan Resolution** 1,200 x 2,400 dpi
- Scan Speed** Monochrome 200 dpi: 12 sec
Colour 200 dpi: 27 sec
- Connectivity** USB 2.0, Ethernet, Wi-Fi IEEE 802.11b/g/n, Wi-Fi Direct
- Epson Connect** Epson iPrint, Email Print, Remote Print Driver, Scan to Cloud
- Other Mobile Solution** Apple AirPrint, Mopria Print Service, Epson Smart Panel
- Warranty** 2 years or 50,000 pages
- Ink Model** 001 (B - Pigment, CMY - Dye)
- Maintenance Box** C13T04D100

L5290



- Printer Type** Print, Scan, Copy, Fax with ADF
- Technology** On Demand Inkjet (Piezoelectric)
- Ink** 4 Colours Epson Genuine Ink Bottle
- Print Resolution** 5,760 x 1,440 dpi (with Variable-Sized Droplet Technology)
- Print Speed** Approx. 33 ppm / 15 ppm
- Copy Resolution** 600 x 600 dpi
- Copy Speed** Up to 7.7 ipm / 3.8 ipm
- Scan Resolution** 1,200 x 2,400 dpi
- Scan Speed** Monochrome - Flatbed : 12 sec / ADF : 4.5 ipm
Colour - Flatbed : 29 sec / ADF : 4.5 ipm
- Connectivity** USB 2.0, Ethernet, Wi-Fi IEEE 802.11b/g/n, Wi-Fi Direct
- Epson Connect** Epson iPrint, Epson Email Print, Remote Print Driver
- Other Mobile Solution** Apple AirPrint, Mopria Print Service, Epson Smart Panel
- Warranty** 2 years or 30,000 pages
- Ink Model** 003 (BCMY - Dye)

INKTANK PRINTER

Printer Warna Printer Multifungsi untuk Perkantoran / SOHO

INKTANK PRINTER

L5590



- Printer Type** Print, Scan, Copy, Fax with ADF
- Technology** PrecisionCore Printhead
- Ink** 4 Colours Epson Genuine Ink Bottle
- Print Resolution** 4800 x 1200 dpi
(with Variable-Sized Droplet Technology)
- Print Speed** up to 33 ppm / 20 ppm
- Copy Resolution** 600 x 600 dpi
- Copy Speed** up to 10.8 ipm / 5.5 ipm
- Scan Resolution** 1,200 x 2,400 dpi
- Scan Speed** Monochrome 200 dpi - 12 sec / 5.0 ipm
Colour 200 dpi - 29 sec / 5.0 ipm
- Connectivity** USB 2.0, Ethernet, Wi-Fi IEEE 802.11b/g/n, Wi-Fi Direct
- Epson Connect** Epson iPrint, Epson Email Print, Remote Print Driver
- Other Mobile Solution** Apple AirPrint, Mopria Print Service, Epson Smart Panel
- Warranty** 2 years or 50,000 pages
- Ink Model** 003 (BCMY - Dye)
- Maintenance Box** C12C934461

L4260

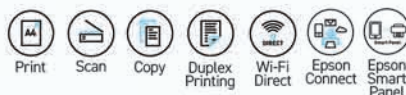

- Printer Type** Print, Scan, Copy
- Technology** On Demand Inkjet (Piezoelectric)
- Ink** 4 Colours Epson Genuine Ink Bottle
- Print Resolution** 5,760 x 1,440 dpi
(with Variable-Sized Droplet Technology)
- Print Speed** Up to 33 ppm / 15 ppm
- Copy Resolution** 600 x 600 dpi
- Copy Speed** Up to 7.7 ipm / 3.8 ppm
- Scan Resolution** 1,200 x 2,400 dpi
- Scan Speed** Monochrome 200 dpi: 11 sec
Colour 200 dpi: 28 sec
- Connectivity** USB 2.0, Wi-Fi IEEE 802.11b/g/n, Wi-Fi Direct
- Epson Connect** Epson iPrint, Epson Email Print, Remote Print Driver
- Other Mobile Solution** Apple AirPrint, Mopria Print Service, Epson Smart Panel
- Warranty** 2 years or 30,000 pages
- Ink Model** 001 (B - Pigment, CMY - Dye)

INKTANK PRINTER

Printer Warna Printer Multifungsi untuk Perkantoran / SOHO



L6460



- Printer Type** Print, Scan, Copy with ADF
- Technology** PrecisionCore™ Printhead
- Ink** 4 colours pigment Epson Genuine Ink Bottle
- Print Resolution** 4,800 x 1,200 dpi (with Variable-Sized Droplet Technology)
- Print Speed** Up to 37 ppm / 23 ppm
- Copy Resolution** 600 x 600 dpi
- Copy Speed** Up to 12 ipm / 6 ppm
- Scan Resolution** 1,200 x 2,400 dpi
- Scan Speed** Monochrome 200 dpi: Flatbed 12 ipm/ 6 ipm, ADF ; 10 ipm/5 ipm
Colour 200 dpi: 27 sec, ADF : 5 ipm
- Connectivity** USB 2.0, Ethernet, Wi-Fi IEEE 802.11b/g/n, Wi-Fi Direct
- Epson Connect** Epson iPrint, Email Print, Remote Print Driver, Scan to Cloud
- Other Mobile Solution** Apple AirPrint, Mopria Print Service, Epson Smart Panel
- Warranty** 2 years or 50,000 pages
- Ink Model** 008 (All Colors - Pigment)
- Maintenance Box** C13T04D100



L6490

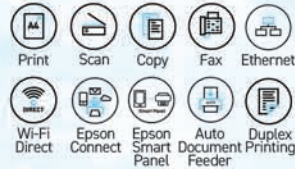

- Printer Type** Print, Scan, Copy, Fax with ADF
- Technology** PrecisionCore™ Printhead
- Ink** 4 colours pigment Epson Genuine Ink Bottle
- Print Resolution** 4,800 x 1,200 dpi (with Variable-Sized Droplet Technology)
- Print Speed** Up to 37 ppm / 23 ppm
- Copy Resolution** 600 x 600 dpi
- Copy Speed** Up to 12 ipm / 6 ppm
- Scan Resolution** 1,200 x 2,400 dpi
- Scan Speed** Monochrome 200 dpi: Flatbed 12 ipm/ 6 ipm, ADF ; 10 ipm/5 ipm
Colour 200 dpi: 27 sec, ADF : 5 ipm
- Connectivity** USB 2.0, Ethernet, Wi-Fi IEEE 802.11b/g/n, Wi-Fi Direct
- Epson Connect** Epson iPrint, Email Print, Remote Print Driver, Scan to Cloud
- Other Mobile Solution** Apple AirPrint, Mopria Print Service, Epson Smart Panel
- Warranty** 2 years or 50,000 pages
- Ink Model** 008 (All Colors - Pigment)
- Maintenance Box** C13T04D100

INKTANK PRINTER

Printer Warna Printer Multifungsi untuk Perkantoran / SOHO

INKTANK PRINTER

L14150



- Printer Type** Print, Scan, Copy, Fax with ADF
- Technology** PrecisionCore™ Printhead
- Ink** 4 Colours Epson Genuine Ink Bottle
- Print Resolution** 4,800 x 1,200 dpi
- Print Speed** Up to 38 ppm / 24 ppm
- Copy Resolution** 600 x 600 dpi
- Copy Speed** Up to 11.5 ipm / 5.5 ipm
- Scan Resolution** 1,200 x 2,400 dpi
- Scan Speed** monochrome, 200 dpi; Flatbed : 13 sec / ADF : 5 ipm
Color, 200 dpi; Flatbed : 28 sec / ADF : 5 ipm
- Connectivity** USB 2.0, Ethernet, Wi-Fi IEEE 802.11b/g/n, Wi-Fi Direct
- Epson Connect** Epson iPrint, Epson Email Print, Remote Print Driver, Scan to Cloud
- Other Mobile Solution** Apple AirPrint, Mopria Print Service, Epson Smart Panel
- Warranty** 2 years or 80,000 pages
- Ink Model** 001 (B - Pigment, CMY - Dye)
- Maintenance Box** C13T04D100



Total Nilai TKDN + BMP
37.48%

L15150



- Printer Type** Print, Scan, Copy, Fax with ADF
- Technology** PrecisionCore™ Printhead
- Ink** 4 Colours Epson Genuine Ink Bottle
- Print Resolution** 4800 x 2400 dpi (with Variable-sized Droplet Technology)
- Print Speed** Approx; 32.0 ppm / 22.0 ppm
- Copy Resolution** 600 x 600 dpi
- Copy Speed** 23.0 ipm / 10.0 ipm
- Scan Resolution** 1200 x 2400 dpi
- Scan Speed** Black 200 dpi : Flatbed : 5 sec / ADF (Simplex / Duplex) : 26.0 ipm / 11.5 ipm
Colour 200 dpi : Flatbed : 10 sec / ADF (Simplex / Duplex) : 9.0 ipm / 6.0 ipm
- Connectivity** USB 2.0 Hi-speed, Ethernet, Wi-Fi IEEE 802.11b/g/n, Wi-Fi Direct
- Epson Connect** Epson iPrint, Email Print, Remote Print Driver, Scan to Cloud
- Other Mobile Solutions** Apple AirPrint, Mopria Print Service, Epson Smart Panel
- Warranty** 2 years or 80.000 pages
- Ink Model** 008 (All Colors - Pigment)
- Maintenance Box** C12C934591



INKTANK PRINTER

Printer Warna Printer Multifungsi untuk SOHO / Rumah



L3250



Printer Type Print, Scan, Copy
Technology On Demand Inkjet (Piezoelectric)
Ink 4 Colours Epson Genuine Ink Bottle
Print Resolution 5,760 x 1,440 dpi
(with Variable-Sized Droplet Technology)
Print Speed Approx. 33 ppm / 15 ppm
Copy Resolution 600 x 600 dpi
Copy Speed Up to 7.0 ipm / 1.7 ipm
Scan Resolution 1200 x 2400 dpi
Scan Speed Monochrome 200 dpi: 11 sec
Colour 200 dpi: 28 sec
Connectivity USB 2.0, Wi-Fi, Wi-Fi Direct
Epson Connect Epson iPrint, Epson Email Print,
Remote Print Driver
Epson Smart Panel
Other Mobile Solution Epson Smart Panel
Warranty 2 years or 30,000 pages
Ink Model 003 (BCMY - Dye)



L3550



Printer Type Print, Scan, Copy
Technology PrecisionCore Printhead
Ink 4 Colours Epson Genuine Ink Bottle
Print Resolution 4,800 x 1,200 dpi
(with Variable-Sized Droplet Technology)
Print Speed up to 33 ppm / 20 ppm
Copy Resolution 600 x 600 dpi
Copy Speed up to 10.8 ipm / 5.5 ipm
Scan Resolution 1200 x 2400 dpi
Scan Speed Monochrome 200 dpi: 11 sec
Colour 200 dpi: 28 sec
Connectivity USB 2.0, Wi-Fi IEEE 802.11b/g/n, Wi-Fi Direct
Epson Connect Epson iPrint, Epson Email Print,
Remote Print Driver
Apple AirPrint, Mopria Parint Service, Epson
Smart Panel
Other Mobile Solution Apple AirPrint, Mopria Parint Service, Epson
Smart Panel
Warranty 2 years or 50,000 pages
Ink Model 003 (BCMY - Dye)
Maintenance Box C12C934461



L3210



Printer Type Print, Scan, Copy
Technology On Demand Inkjet (Piezoelectric)
Ink 4 Colours Epson Genuine Ink Bottle
Print Resolution 5,760 x 1,440 dpi
(with Variable-Sized Droplet Technology)
Print Speed Approx. 33 ppm / 15 ppm
Copy Resolution 600 x 600 dpi
Copy Speed Up to 7.0 ipm / 1.7 ipm
Scan Resolution 600 x 1,200 dpi
Scan Speed Monochrome 200 dpi: 11 sec
Colour 200 dpi: 32 sec
Connectivity USB 2.0 Hi-speed
Warranty 2 years or 30,000 pages
Ink Model 003 (BCMY - Dye)

INKTANK PRINTER

Printer Warna Printer Fungsi Tunggal untuk Foto



L8050



Printer Type	Print
Technology	On Demand Inkjet (Piezoelectric)
Ink	6 Colours Epson Genuine Ink Bottle
Print Resolution	5,760 x 1,440 dpi (with Variable-Sized Droplet Technology)
Print Speed	up to 22 ppm / 22 ppm
Connectivity	USB 2.0, Wi-Fi IEEE 802.11b/g/n, Wi-Fi Direct
CD Print/ID Card Print	Yes/Yes
Epson Connect	Epson iPrint, Epson Email Print, Remote Print Driver
Other Mobile Solution	Epson Smart Panel
Warranty	2 years or 50,000 pages
Ink Model	057 (All Colors - Dye)
Maintenance Box	C12C934591
Pick Up Roller	C12C937771

Printer Warna Printer Multi Fungsi untuk Foto



L8100



Printer Type	Print, Scan, Copy
Technology	On Demand Inkjet (Piezoelectric)
Ink	6 Colours Epson Genuine Ink Bottle
Print Resolution	5,760 x 1,440 dpi (with Variable-Sized Droplet Technology)
Print Speed	Up to 22 ppm / 22 ppm
Copy Resolution	5,760 x 1,440 dpi
Copy Speed	Up to 7.5 ppm / 7.5 ppm
Scan Resolution	1,200 x 4,800 dpi
Scan Speed	Monochrome 200 dpi : up to 6 sec Colour 200 dpi : up to 11 sec
Connectivity	USB 2.0, Wi-Fi IEEE 802.11b/g/n, Wi-Fi Direct
Warranty	2 years or 50,000 pages
Ink Model	057 (All Colors - Dye)
Maintenance Box	C12C934591
Pick Up Roller	C12C937771

INKTANK PRINTER

Printer Warna Printer Fungsi Tunggal untuk Foto

L18050



Printer Type	Print - A3 Size
Technology	On Demand Inkjet (Piezoelectric)
Ink	6 Colours Epson Genuine Ink Bottle
Print Resolution	5,760 x 1,440 dpi (with Variable-Sized Droplet Technology)
Print Speed	up to 22 ppm / 22 ppm
Connectivity	USB 2.0, Wi-Fi IEEE 802.11b/g/n, Wi-Fi Direct
CD Print/ID Card Print	Yes/Yes
Epson Connect	Epson Iprint, Epson Email Print, Remote Print Driver
Other Mobile Solution	Epson Smart Panel
Warranty	2 years or 50,000 pages
Ink Model	057 (All Colors - Dye)
Maintenance Box	C12C934591
Pick Up Roller	C12C937771

Printer Warna Printer Fungsi Tunggal untuk SOHO / Rumah

L121



Printer Type	Print
Technology	on Demand inkjet (piezoelectric)
Ink	4 Colours Epson Genuine Ink Bottle
Print Resolution	720 x 720 dpi (with Variable-Sized Droplet Technology)
Print Speed	up to 9.0 ipm / 4.8 ipm
Connectivity	USB 2.0 Hi-speed
Warranty	2 years or 20,000 pages
Ink Model	664 (BCMY - Dye)

INKTANK PRINTER

Printer Warna
Printer Fungsi Tunggal untuk SOHO / Rumah

INKTANK PRINTER



L1210



Print

Printer Type

on Demand inkjet (piezoelectric)

Technology

Ink 4 Colours Epson Genuine Ink Bottle

Print Resolution

5760 x 1440 dpi
(with Variable-Sized Droplet Technology)

Print Speed

up to 33.0 ppm / 15.0 ppm

Connectivity

USB 2.0 Hi-speed

Warranty

2 Years or 30,000 pages

Ink Model

003 (BCMY – Dye)

L1250



Print



Wi-Fi Direct



Epson Connect



Epson Smart Panel

Printer Type

Print

Technology

on Demand inkjet (piezoelectric)

Ink 4 Colours Epson Genuine Ink Bottle

Print Resolution

5760 x 1440 dpi
(with Variable-Sized Droplet Technology)

Print Speed

up to 33.0 ppm / 15.0 ppm

Connectivity

USB 2.0, Wi-Fi, Wi-Fi Direct

Epson Connect

Epson iPrint, Epson Email Print, Remote Print Driver

Other Mobile Solution

Epson Smart Panel

Warranty

2 Years or 30,000 pages

Ink Model

003 (BCMY – Dye)



INKTANK PRINTER

Printer Warna
Printer Fungsi Tunggal untuk SOHO / Rumah

L11050



Printer Type	Print - A3 Size
Technology	PrecisionCore Printhead
Ink	4 Colours Epson Genuine Ink Bottle
Print Resolution	4,800 x 1,200 dpi (with Variable-Sized Droplet Technology)
Print Speed	Approx. 30 ppm / 20 ppm
Connectivity	USB 2.0, Wi-Fi, Wi-Fi Direct
Epson Connect	Epson Smart Panel, Epson Email Print, Remote Print Driver
Warranty	2 years or 30,000 pages
Ink Model	003 (BCMY - Dye)
Maintenance Box	C13T04D100
Pick Up Roller	C12C937771

Inkjet Portable Printer

WORKFORCE PRO WF-100



Print Tech	Micro Piezo™ Printhead
Print Type	Print (Single Function)
Print Resolution	5,760 x 1,440 dpi (with Variable-Sized Droplet Technology)
Print Speed	Draft, A4 (Black / Colour): Up to 14 ppm / 11 ppm ISO 24734, A4 Simplex (Black / Colour): Up to 7.0 ipm / 4.0 ipm
Paper Size	Legal, Letter, A4, B5, A5, A6, 8x10", 5x7", 4x6", Envelopes: #10, DL, C6
Power Consumption	Operating: Approx 11 W Standby: Approx 4.0 W Sleep: Approx 1.3 W
Connectivity	Hi-Speed USB 2.0, Wi-Fi (IEEE 802.11b/g/n) Wi-Fi Direct
Epson Connect	Epson iPrint, Epson Email Print, Remote Print Driver, Epson Creative Print
Other Mobile Solutions	Apple AirPrint, Google Cloud Print, Mopria Print Service
Consumable	Up to 250 pages* for black ink pack (T289BK) & 200 pages* for color ink pack (T290CL)

INKTANK PRINTER

Printer Monokrom
Printer Multifungsi untuk Perkantoran / SOHO

INKTANK PRINTER

M3170



- Printer Type** Print, Scan, Copy, Fax with ADF
- Technology** PrecisionCore™ Printhead
- Ink** Black Pigment Epson genuine Ink Bottle
- Print Resolution** 1,200 x 2,400 dpi
(with Variable-Sized Droplet Technology)
- Print Speed** Up to 39 ppm
- Copy Speed** Up to 17 ipm
- Scan Resolution** 1,200 x 2,400 dpi
- Scan Speed** Monochrome 200 dpi: 12 sec
Colour 200 dpi: 27 sec
- Connectivity** USB 2.0 Hi-speed, Ethernet, Wi-Fi IEEE 802.11b/g/n, Wi-Fi Direct
- Epson Connect** Epson iPrint, Email Print, Remote Print Driver, Scan to Cloud
- Other Mobile Solution** Apple AirPrint, Google Cloud Print, Morpria Print Service
- Warranty** 4 years or 50,000 pages
- Ink Model** 005 (B - Pigment)
- Maintenance Box** C13T04D100

M2140



- Printer Type** Print, Scan, Copy
- Technology** PrecisionCore™ Printhead
- Ink** Black Pigment Epson genuine Ink Bottle
- Print Resolution** 1,200 x 2,400 dpi
(with Variable-Sized Droplet Technology)
- Print Speed** Up to 39 ppm
- Copy Resolution** 600 x 600 dpi
- Copy Speed** Up to 17 ipm
- Scan Resolution** 1,200 x 2,400 dpi
- Scan Speed** Monochrome 200 dpi: 12 sec
Colour 200 dpi: 27 sec
- Connectivity** USB 2.0 Hi-speed
- Warranty** 4 years or 50,000 pages
- Ink Model** 005 (B - Pigment)

INKTANK PRINTER

Printer Monokrom
Printer Multifungsi untuk Perkantoran / SOHO



Total Nilai
TKDN + BMP
47.96%

M15140



- Printer Type** Print, Scan, Copy, ADF
- Technology** PrecisionCore™ Printhead
- Ink** Black Pigment Epson genuine Ink Bottle
- Print Resolution** 4800 x 2400 dpi (with Variable-sized Droplet Technology)
- Print Speed** up to 32.0 ppm
- Copy resolution** 600 x 600 dpi
- Copy speed** up to 23.0 ipm
- Scan Resolution** 1200 x 2400 dpi
- Scan Speed** Black 200 dpi : Flatbed : 5 sec / ADF (Simplex / Duplex) : 26.0 ipm / 11.5 ipm
- Connectivity** USB 2.0, Ethernet, Wi-Fi IEEE 802.11b/g/n, Wi-Fi Direct
- Epson Connect** Epson iPrint, Epson Email Print, Remote Print Driver, Scan to Cloud
- Other Mobile Solution** Apple AirPrint, Mopria Print Service, Smart Panel
- Warranty** 4 years or 150.000 pages
- Ink Model** 008 (B - Pigment)
- Maintenance Box** C12C934591

M2170



- Printer Type** Print, Scan, Copy
- Technology** PrecisionCore™ Printhead
- Ink** Black Pigment Epson genuine Ink Bottle
- Print Resolution** 1,200 x 2,400 dpi (with Variable-Sized Droplet Technology)
- Print Speed** Up to 39 ppm
- Copy Resolution** 600 x 600 dpi
- Copy Speed** Simplex: Up to 17.0 ipm
- Scan Resolution** 1,200 x 2,400 dpi
- Scan Speed** Monochrome 200 dpi: 12 sec
Colour 200 dpi: 27 sec
- Connectivity** USB 2.0, Wi-Fi IEEE 802.11b/g/n, Wi-Fi Direct, Ethernet
- Epson Connect** Epson iPrint, Epson Email Print, Remote Print Driver
- Other Mobile Solution** Apple AirPrint, Mopria Print Service
- Warranty** 4 years or 50,000 pages
- Ink Model** 005 (B - Pigment)
- Maintenance Box** C13T04D100

INKTANK PRINTER

Printer Monokrom Printer Multifungsi untuk Perkantoran / SOHO / Rumah



M2050



Printer Type	Print, Scan, Copy with ADF
Technology	PrecisionCore Printhead
Ink	Black Pigment Epson genuine Ink Bottle
Print Resolution	1,200 x 2,400 dpi (with Variable-Sized Droplet Technology)
Print Speed	Up to 33 ppm
Connectivity	USB 2.0 Hi-speed, Wi-Fi IEEE 802.11b/g/n, Wi-Fi Direct, Ethernet
Epson Connect	Epson iPrint, Epson Email Print, Remote Print Driver
Other Mobile Solution	Google Cloud Print
Warranty	4 years or 50,000 pages
Ink Model	005 (B - Pigment)
Maintenance Box	C12C938731

Printer Monokrom Printer Fungsi Tunggal untuk Perkantoran / SOHO / Rumah



M1050



Printer Type	Print
Technology	PrecisionCore Printhead
Ink	Black Pigment Epson genuine Ink Bottle
Print Resolution	1,200 x 2,400 dpi (with Variable-Sized Droplet Technology)
Print Speed	Up to 33 ppm
Connectivity	USB 2.0 Hi-speed, Wi-Fi IEEE 802.11b/g/n, Wi-Fi Direct, Ethernet
Epson Connect	Epson iPrint, Epson Email Print, Remote Print Driver
Other Mobile Solution	Google Cloud Print
Warranty	4 years or 50,000 pages
Ink Model	005 (B - Pigment)
Maintenance Box	C12C938731



M1140



Printer Type	Print
Technology	PrecisionCore™ Printhead
Ink	Black Pigment Epson genuine Ink Bottle
Print Resolution	1,200 x 2,400 dpi (with Variable-Sized Droplet Technology)
Print Speed	Up to 39 ppm
Connectivity	USB 2.0 Hi-speed
Warranty	4 Years or 50,000 pages
Ink Model	005 (B - Pigment)

INKTANK PRINTER

Printer Monokrom
Printer Fungsi Tunggal untuk Perkantoran / SOHO / Rumah

M1120



- Printer Type** Print
Technology On Demand Inkjet (Piezoelectric)
Ink Black Pigment Epson genuine Ink Bottle
Print Resolution 1,440 x 720 dpi
(with Variable-Sized Droplet Technology)
Print Speed Up to 32 ppm
Connectivity USB 2.0 Hi-speed, Wi-Fi IEEE 802.11b/g/n, Wi-Fi Direct
Epson Connect Epson iPrint, Epson Email Print, Remote Print Driver
Other Mobile Solution Google Cloud Print
Warranty 4 years or 50,000 pages
Ink Model 005 (B - Pigment)



M1100



- Printer Type** Print
Technology On Demand Inkjet (Piezoelectric)
Ink Black Pigment Epson genuine Ink Bottle
Print Resolution 1,440 x 720 dpi
(with Variable-Sized Droplet Technology)
Print Speed Up to 32 ppm
Connectivity USB 2.0 Hi-speed
Warranty 4 years or 50,000 pages
Ink Model 005 (B - Pigment)



M1170



- Printer Type** Print
Technology PrecisionCore Printhead
Ink Black Pigment Epson genuine Ink Bottle
Print Resolution 1,200 x 2,400 dpi
(with Variable-Sized Droplet Technology)
Print Speed up to 39 ppm
Connectivity USB 2.0, Wi-Fi IEEE 802.11b/g/n, Wi-Fi Direct, Ethernet
Epson Connect Epson iPrint, Epson Email Print, Remote Print Driver
Other Mobile Solution Mopria Print Service
Warranty 4 years or 50,000 pages
Ink Model 005 (B - Pigment)
Maintenance Box C13T04D100



INKTANK PRINTER- 3 Years Warranty



L1211



Print

Printer Type Print
Technology on Demand inkjet (piezoelectric)
Ink 4 Colours Epson Genuine Ink Bottle
Print Resolution 5760 x 1440 dpi
(with Variable-Sized Droplet Technology)
Print Speed up to 33.0 ppm / 15.0 ppm
Connectivity USB 2.0 Hi-speed
Warranty **3 Years or 30,000 pages**
Ink Model 003 (BCMY - Dye)



L1251



Print



Wi-Fi Direct



Epson Connect



Epson Smart Panel

Printer Type Print
Technology on Demand inkjet (piezoelectric)
Ink 4 Colours Epson Genuine Ink Bottle
Print Resolution 5760 x 1440 dpi
(with Variable-Sized Droplet Technology)
Print Speed up to 33.0 ppm / 15.0 ppm
Connectivity USB 2.0 Hi Speed, Wi-Fi, Wi-Fi Direct
Epson Connect Epson iPrint, Epson Email Print, Remote Print Driver
Other Mobile Solution Epson Smart Panel
Warranty **3 Years or 30,000 pages**
Ink Model 003 (BCMY - Dye)



L3211



Print



Scan



Copy

Printer Type Print, Scan, Copy
Technology On Demand Inkjet (Piezoelectric)
Ink 4 Colours Epson Genuine Ink Bottle
Print Resolution 5,760 x 1,440 dpi
(with Variable-Sized Droplet Technology)
Print Speed Approx. 33 ppm / 15 ppm
Copy Resolution 600 x 600 dpi
Copy Speed Up to 7.0 ipm / 1.7 ipm
Scan Resolution 600 x 1,200 dpi
Scan Speed Monochrome 200 dpi: 11 sec
Colour 200 dpi: 32 sec
Connectivity USB 2.0 Hi-speed
Warranty **3 years or 30,000 pages**
Ink Model 003 (BCMY - Dye)

INKTANK PRINTER- 3 Years Warranty

L3251



Printer Type Print, Scan, Copy
Technology On Demand Inkjet (Piezoelectric)
Ink 4 Colours Epson Genuine Ink Bottle
Print Resolution 5,760 x 1,440 dpi
 (with Variable-Sized Droplet Technology)
Print Speed Approx. 33 ppm / 15 ppm
Copy Resolution 600 x 600 dpi
Copy Speed Up to 7.7 ipm / 3.8 ipm
Scan Resolution 1200 x 2400 dpi
Scan Speed Monochrome 200 dpi: 11 sec
 Colour 200 dpi: 28 sec
Connectivity USB 2.0, Wi-Fi, Wi-Fi Direct
Epson Connect Epson iPrint, Epson Email Print, Remote Print Driver
Other Mobile Solution Epson Smart Panel
Warranty 3 years or 30,000 pages
Ink Model 003 (BCMY – Dye)

L4261



Printer Type Print, Scan, Copy
Technology On Demand Inkjet (Piezoelectric)
Ink 4 Colours Epson Genuine Ink Bottle
Print Resolution 5,760 x 1,440 dpi
 (with Variable-Sized Droplet Technology)
Print Speed Up to 33 ppm / 15 ppm
Copy Resolution 600 x 600 dpi
Copy Speed Up to 7.7 ipm / 3.8 ipm
Scan Resolution 1,200 x 2,400 dpi
Scan Speed Monochrome 200 dpi: 11 sec
 Colour 200 dpi: 28 sec
Connectivity USB 2.0, Wi-Fi IEEE 802.11b/g/n, Wi-Fi Direct
Epson Connect Epson iPrint, Epson Email Print, Remote Print Driver
Other Mobile Solution Apple AirPrint, Mopria Print Service, Epson Smart Panel
Warranty 3 years or 30,000 pages
Ink Model 001 (B – Pigment, CMY – Dye)

INKTANK PRINTER (Available Only In Epson Official Store)

L1216



Print



Printer Type Print
Technology on Demand inkjet (piezoelectric)
Ink 4 Colours Epson Genuine Ink Bottle
Print Resolution 5760 x 1440 dpi
 (with Variable-Sized Droplet Technology)
Print Speed up to 33.0 ppm / 15.0 ppm
Connectivity USB 2.0 Hi-speed
Warranty 2 Years or 30,000 pages
Ink Model 003 (BCMY – Dye)

L1256



Print



Wi-Fi Direct



Epson Connect



Epson Smart Panel



Printer Type Print
Technology on Demand inkjet (piezoelectric)
Ink 4 Colours Epson Genuine Ink Bottle
Print Resolution 5760 x 1440 dpi
 (with Variable-Sized Droplet Technology)
Print Speed up to 33.0 ppm / 15.0 ppm
Connectivity USB 2.0, Wi-Fi, Wi-Fi Direct
Epson Connect Epson iPrint, Epson Email Print, Remote Print Driver
Other Mobile Solution Epson Smart Panel
Warranty 2 Years or 30,000 pages
Ink Model 003 (BCMY – Dye)

L3216



Print



Scan



Copy



Printer Type Print, Scan, Copy
Technology On Demand Inkjet (Piezoelectric)
Ink 4 Colours Epson Genuine Ink Bottle
Print Resolution 5,760 x 1,440 dpi
 (with Variable-Sized Droplet Technology)
Print Speed Approx. 33 ppm / 15 ppm
Copy Resolution 600 x 600 dpi
Copy Speed Up to 7.0 ipm / 1.7 ipm
Scan Resolution 600 x 1,200 dpi
Scan Speed Monochrome 200 dpi: 11 sec
 Colour 200 dpi: 32 sec
Connectivity USB 2.0 Hi-speed
Warranty 2 years or 30,000 pages
Ink Model 003 (BCMY – Dye)

INKTANK PRINTER [Available Only In Epson Official Store]

L3256



Printer Type
Technology
Ink
Print Resolution
Print Speed
Copy Resolution
Copy Speed
Scan Resolution
Scan Speed
Connectivity
Epson Connect
Other Mobile Solution
Warranty
Ink Model

Print, Scan, Copy
On Demand Inkjet (Piezoelectric)
4 Colours Epson Genuine Ink Bottle
5,760 x 1,440 dpi
(with Variable-Sized Droplet Technology)
Approx. 33 ppm / 15 ppm
600 x 600 dpi
Up to 7.0 ipm / 1.7 ipm
1200 x 2400 dpi
Monochrome 200 dpi: 11 sec
Colour 200 dpi: 28 sec
USB 2.0, Wi-Fi, Wi-Fi Direct
Epson iPrint, Epson Email Print,
Remote Print Driver
Epson Smart Panel
2 years or 30,000 pages
003 (BCMY - Dye)

L3556



Printer Type
Technology
Ink
Print Resolution
Print Speed
Copy Resolution
Copy Speed
Scan Resolution
Scan Speed
Connectivity
Epson Connect
Other Mobile Solution
Warranty
Ink Model
Maintenance Box

Print, Scan, Copy
PrecisionCore Printhead
4 Colours Epson Genuine Ink Bottle
4,800 x 1,200 dpi
(with Variable-Sized Droplet Technology)
Approx. 33 ppm / 20 ppm
600 x 600 dpi
up to 10.8 ipm / 5.5 ipm
1200 x 2400 dpi
Monochrome 200 dpi: 11 sec
Colour 200 dpi: 28 sec
USB 2.0, Wi-Fi IEEE 802.11b/g/n, Wi-Fi Direct
Epson iPrint, Epson Email Print,
Remote Print Driver
Epson Smart Panel
2 years or 50,000 pages
003 (BCMY - Dye)
C12C934461

L5296

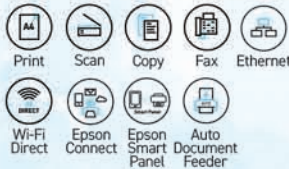

Printer Type
Technology
Ink
Print Resolution
Print Speed
Copy Resolution
Copy Speed
Scan Resolution
Scan Speed
Connectivity
Epson Connect
Other Mobile Solution
Warranty
Ink Model

Print, Scan, Copy, Fax with ADF
On Demand Inkjet (Piezoelectric)
4 Colours Epson Genuine Ink Bottle
5,760 x 1,440 dpi
(with Variable-Sized Droplet Technology)
Approx. 33 ppm / 15 ppm
600 x 600 dpi
Up to 7.7 ipm / 3.8 ipm
1,200 x 2,400 dpi
Monochrome - Flatbed : 12 sec / ADF : 4.5 ipm
Colour - Flatbed : 29 sec / ADF : 4.5 ipm
USB 2.0, Ethernet, Wi-Fi IEEE 802.11b/g/n,
Wi-Fi Direct
Epson iPrint, Epson Email Print, Remote Print
Driver
Apple AirPrint, Mopria Print Service,
Epson Smart Panel
2 years or 30,000 pages
003 (BCMY - Dye)

INK CONSUMABLES



SINGLE-FUNCTION INKJET PRINTER	T664 series	003 series	001 series	008 series	T673 series	057 series	T7741	005
L100/L110/L120	●							
L300/L310	●							
L121	●							
L1110		●						
L1210/L1216/ L1211		●						
L1250/L1256/ L1251		●						
L1300	●							
MULTI-FUNCTION INKJET PRINTER	T664 series	003 series	001 series	008 series	T673 series	057 series	T7741	005
L200/L210/L220	●							
L350/L360/L380	●							
L355/L365/L385	●							
L550/L555/L565	●							
L455/L485	●							
L605/L655	●						●	
L1455	●						●	
L3110/L3116		●						
L3150/L3156		●						
L3210/L3216/ L3211		●						
L3250/L3256/ L3251		●						
L3550/L3556		●						
L4150/L4160			●					
L4260/L4261			●					
L5190		●						
L5290/L5296		●						
L5590		●						
L6160/L6170/ L6190			●					
L6260/L6270/ L6290			●					
L6460				●				
L6490				●				
L14150			●					
L15150				●				
PHOTO INKJET PRINTER	T664 series	003 series	001 series	008 series	T673 series	057 series	T7741	005
L800/L805					●			
L8050						●		
L850					●			
L1800					●			
L18050						●		
L8100						●		

INK CONSUMABLES



MONOCHROME INKJET PRINTER	T664 series	003 series	001 series	008 BK	T673 series	057 series	T7741	005
M100/M200							●	
M1050								●
M1100								●
M1120								●
M1140								●
M1170								●
M2050								●
M2140								●
M2170								●
M3170								●
M15140				●				

Epson Claria™ Photographic Ink



Photo Inkjet Printer

Picture Print
T58290

- Epson PictureMate® PM235/310
- Epson PictureMate® PM210/215
- Epson PictureMate® PM250/270

DURABrite Ultra Inks

Ink Code

Epson WorkForce WF-7111 / WF-7611	T188 Series
Epson WorkForce WF-100	C13T289190 Btk Ink (Pigment)
	C13T290090 Ctr Ink (Pigment)

List Maintenance Box for Consumer Product

(Lseries, Mseries & Other Model)

MATERIAL CODE	DESCRIPTION	COMPATIBILITY		
		Lseries	Mseries	Others
C13T295000	WF-100 Maintenance Box			WF-100
C13T295100	Maintenance box PM-520			PictureMate PM 520
C13T671000	MAINTENANCE BOX			WP-4011, WP-4511, WP-4521, WF-5111, WF-5621
C13T671100	MAINTENANCE BOX	L1455		WF-3011, WF-3521, WF-7211, WF-7711
C13T04D100	MAINTENANCE BOX	L6160, L6170, L6190, L6260, L6270, L6290, L6460, L6490, L11050, L14150	M1140, M1170, M2140, M2170, M3170	
C12C934591	MAINTENANCE BOX	L8050, L8100, L15150, L18050	M15140	
C12C934461	MAINTENANCE BOX	L3550, L5590, L3556		
C12C937771	Pickup Roller	L8050, L8100, L11050, L18050		
C12C938731	MAINTENANCE BOX		M1050, M2050	

BUSINESS INKJET PRINTER



ECO

BUSINESS INKJET PRINTER

MENGAPA MEMILIH BUSINESS INKJET PRINTER ?

Epson business inkjet printers menghadirkan kualitas yang luar biasa, kecepatan sangat cepat, handal dan kinerja yang optimal untuk memenuhi kebutuhan bisnis Anda.

Revolutionary Compact PrecisionCore Linehead Design

Advanced built-in Nozzle Verification Technology memonitor kondisi nozzle dan kualitas cetak menyesuaikan secara otomatis tanpa interupsi, bahkan selama pencetakan.



Heat-Free Technology

Teknologi Heat-Free tidak membutuhkan panas dalam proses pengeluaran tinta. Sebaliknya tekanan diterapkan pada Piezo Element, yang melentur ke belakang dan meneruskan tinta dari printhead ke depan.



The Ecological Choice

Lakukan lebih banyak untuk bisnis Anda dan tetap lebih ramah lingkungan. Beralih ke Epson inkjet printer dan lihat bagaimana Anda dapat meningkatkan produktivitas yang lebih tinggi dan menurunkan emisi berbahaya dalam sehari-hari.

Printer inkjet kami menggunakan daya lebih kecil dari printer laser lainnya sehingga Anda tidak hanya peduli terhadap lingkungan, tetapi Anda menghemat biaya juga.

Jumlah karbon dioksida yang dipancarkan oleh laser printer akan membutuhkan hingga 8 pohon untuk menyerap semua karbon dioksida sedangkan printer inkjet Epson hanya butuh 1 pohon.

Part yang terbuang dari Printer inkjet lebih sedikit dibandingkan printer laser.

Epson Inkjet Printers Up to 85% less power consumption¹ VS Laser Printers

Epson Inkjet Printers Up to 85% less CO₂ generated² VS Laser Printers

Epson Inkjet Printers Up to 59% less replacement parts³ VS Laser Printers

BUSINESS INKJET PRINTER

Single Function Printer A4



Total Nilai
TKDN + BMP
35.09%

WORKFORCE PRO WF-5390



Print Tech	PrecisionCore™ Printhead
Print Type	Print (Single Function)
Print Resolution	4,800 x 1,200 dpi (with Variable-Sized Droplet Technology)
Print Speed	Up to 34 ppm / 34 ppm (Black#1 / Colour#2) - Draft Text - Memo (A4) Up to 24 ipm / 24 ipm (Black / Colour) - ISO 24734, A4, Simplex Up to 15 ipm / 15 ipm (Black / Colour) - ISO 24734, A4, Duplex
Paper Size	A4, 8.5x13", Legal, Letter, Executive, B5, A5, A6, B6, 5x7", 16:9 wide, 4x6", Envelopes: #10, DL, C6, C4
Power Consumption	Operating: 22 Watt Standby: 7 Watt Sleep: 1.2 Watt
Connectivity	USB 2.0, Ethernet, Wi-Fi (IEEE 802.11b/g/n), Wi-Fi Direct, NFC
Epson Connect	Epson iPrint, Epson Email Print, Remote Print Driver
Other Mobile Solutions	Apple AirPrint, Google Cloud Print, Mopria Print Service
Consumable	Up to 10,000 pages* for black ink pack & 3,000 pages* for color ink pack

Multi Function Printer A4



Total Nilai
TKDN + BMP
36.86%

WORKFORCE PRO WF-C5890



Print Tech	PrecisionCore™ Printhead
Print Type	Print, Scan, Copy, Fax with ADF
Print Resolution	4,800 x 1,200 dpi (with Variable-Sized Droplet Technology)
Print Speed	Up to 34 ppm / 34 ppm (Black#1 / Colour#2) - Draft Text - Memo (A4) Up to 24 ipm / 24 ipm (Black / Colour) - ISO 24734, A4, Simplex Up to 15 ipm / 15 ipm (Black / Colour) - ISO 24734, A4, Duplex
Copy Speed	Up to 22 ipm / 22 ipm (Black / Colour) - ISO 29183, A4, Simplex Up to 22 ipm / 22 ipm (Black / Colour) - ISO 24735, A4, 1:1
Scan Speed	Monochrome 200 dpi: Flatbed / ADF (simplex) / ADF (duplex), 5 sec / 24 ppm / 8 ipm Colour 200 dpi: Flatbed / ADF (simplex) / ADF (duplex), 5 sec / 24 ppm / 8 ipm
Scan Resolution	1,200 x 2,400 dpi
Paper Size	A4, 8.5x13", Legal, Letter, Executive, B5, A5, A6, B6, 5x7", 16:9 wide, 4x6", Envelopes: #10, DL, C6, C4
Power Consumption	Operating: 25 Watt Standby: 12 Watt Sleep: 1.5 Watt
Connectivity	USB 2.0, Ethernet, Wi-Fi (IEEE 802.11b/g/n), Wi-Fi Direct, NFC
Epson Connect	Epson iPrint, Epson Email Print, Remote Print Driver, Scan to Cloud
Other Mobile Solutions	Apple AirPrint, Google Cloud Print, Mopria Print Service
Consumable	Up to 10,000 pages* for black ink pack & 3,000 pages* for color ink pack

BUSINESS INKJET PRINTER

Multi Function Printer A4

WORKFORCE PRO WF-C579R



Total Nilai
TKDN + BMP

31.63%

Print Tech	PrecisionCore™ Printhead
Print Type	Print, Scan, Copy, Fax with ADF
Print Resolution	4,800 x 1,200 dpi (with Variable-Sized Droplet Technology)
Print Speed	Up to 34 ppm / 34 ppm (Black#1 / Colour#2) - Draft Text - Memo (A4) Up to 24 ipm / 24 ipm (Black / Colour) - ISO 24734, A4, Simplex Up to 22 ipm / 22 ipm (Black / Colour) - ISO 29183, A4, Simplex
Copy Speed	Up to 22 ipm / 22 ipm (Black / Colour) - ISO 29183, A4, Simplex Up to 22 ipm / 22 ipm (Black / Colour) - ISO 24735, A4, 1:1
Scan Speed	Monochrome 200 dpi: 5 sec (flatbed, A4 Landscape) Colour 200 dpi: 5 sec (flatbed, A4 Landscape) ADF (duplex), 5 sec / 24 ppm / 8 ipm
Scan Resolution	1,200 x 2,400 dpi
Paper Size	A4, 8.5x13", Legal, Letter, Executive, B5, A5, A6, B6, 5x7", 16:9 wide, 4x6", Envelopes: #10, DL, C6, C4
Power Consumption	Operating: 29 Watt Standby: 14 Watt Sleep: 1.3 Watt
Connectivity	USB 2.0, Ethernet, Wi-Fi (IEEE 802.11b/g/n), Wi-Fi Direct
Epson Connect	Epson iPrint, Epson Email Print, Remote Print Driver, Scan to Cloud
Other Mobile Solutions	Apple AirPrint, Google Cloud Print, Mopria Print Service
Consumable	Up to 50,000 pages* ink packs



Total Nilai
TKDN + BMP

41.59%

L6550



Printer Type	Print, Scan, Copy, Fax with ADF
Technology	PrecisionCore™ Printhead
Print Resolution	4,800 x 2,400 dpi
Print Speed	Up to 32 ppm / 22 ppm 25/12 ipm (ISO doc)
Copy Resolution	600 x 600 dpi
Copy Speed	Up to 23 ipm / 10 ipm
Scan Resolution	1,200 x 2,400 dpi
Scan Speed	Monochrome: 200dpi Up to 5.0sec / 27.5 ppm / 11 ipm Colour: 200dpi Up to 10sec / 9.0 ppm / 6.0 ipm
Connectivity	USB 2.0, Ethernet (100BASE-TX/10BASE-T), Wi-Fi (IEEE 802.11 b/g/n), Wi-Fi Direct
Epson Connect	Epson iPrint, Epson Email Print, Remote Print Driver, Scan to Cloud
Other Mobile Solution	Apple AirPrint, Mopria Print Service
Ink Model	008

BUSINESS INKJET PRINTER

Multifunction Printer A4



Total Nilai
TKDN + BMP
41.11%

L6580



Printer Type	Print, Scan, Copy, Fax with ADF
Technology	PrecisionCore™ Printhead
Ink	4 Colours Epson Genuine Ink Bottle
Print Resolution	4,800 x 1,200 dpi
Print Speed	Up to 32 ppm / 32 ppm 25/25 ipm (ISO doc)
Copy Resolution	600 x 600 dpi
Copy Speed	Up to 23 ipm / 23 ipm
Scan Resolution	1,200 x 2,400 dpi
Scan Speed	Monochrome: 5 sec / Up to 27.5 ipm / 11.5 ipm Colour: 10 sec / Up to 9.0 ipm / 6.0 ipm
Connectivity	USB 2.0, Ethernet (100BASE-TX/10BASE-T), Wi-Fi (IEEE 802.11 b/g/n), Wi-Fi Direct
Epson Connect	Epson iPrint, Epson Email Print, Remote Print Driver, Scan to Cloud
Other Mobile Solution	Apple AirPrint, Mopria Print Service
Ink Model	008

Multifunction Printer A3



Total Nilai
TKDN + BMP
38.57%

L15160



Printer Type	Print, Scan, Copy, Fax with ADF
Technology	PrecisionCore™ Printhead
Ink	4 Colours Epson Genuine Ink Bottle
Print Resolution	4,800 x 2,400 dpi
Print Speed	Up to 32 ppm / 32 ppm 25/21 ipm (ISO doc)
Copy Resolution	600 x 600 dpi
Copy Speed	Up to 23 ipm / 23 ipm
Scan Resolution	1,200 x 2,400 dpi
Scan Speed	Black: 5 sec / Up to 26.0 ipm 11.5 ipm Colour: 10 sec / Up to 9.0 ipm 6.0 ipm
Connectivity	USB 2.0, Ethernet, Wi-Fi IEEE 802.11 b/g/n, Wi-Fi Direct
Epson Connect	Epson iPrint, Epson Email Print, Remote Print Driver, Scan to Cloud
Other Mobile Solution	Apple AirPrint, Mopria Print Service
Warranty	2 years or 80,000 prints
Ink Model	008

BUSINESS INKJET PRINTER

Multifunction Printer A3



Total Nilai
TKDN + BMP

38.38%

L15180



Printer Type	Print, Scan, Copy, Fax with ADF
Technology	PrecisionCore™ Printhead
Ink	4 Colours Epson Genuine Ink Bottle
Print Resolution	4,800 x 1,200 dpi
Print Speed	Up to 32 ppm / 32 ppm 25/21 ipm (ISO doc)
Copy Resolution	600 x 600 dpi
Copy Speed	Up to 23 ipm / 23 ipm
Scan Resolution	1,200 x 2,400 dpi
Scan Speed	Black: 5 sec / Up to 26.0 ipm 11.5 ipm Colour: 10 sec / Up to 9.0 ipm 6.0 ipm
Connectivity	USB 2.0, Ethernet, Wi-Fi IEEE 802.11 b/g/n, Wi-Fi Direct
Epson Connect	Epson iPrint, Epson Email Print, Remote Print Driver, Scan to Cloud
Other Mobile Solution	Apple AirPrint, Mopria Print Service
Warranty	2 years or 80,000 prints
Ink Model	008

Monochrome Multifunction Printer A3



Total Nilai
TKDN + BMP

45.07%

M15180



Printer Type	Print, Scan and Copy with ADF
Technology	PrecisionCore™ Printhead
Ink	Black
Print Resolution	4,800 x 2,400 dpi
Print Speed	Up to 32 ppm / 32 ppm 25/16 ipm (ISO doc)
Copy Resolution	600 x 600 dpi
Copy Speed	Up to 23 ipm / 23 ipm
Scan Resolution	1,200 x 2,400 dpi
Scan Speed	Black: 5 sec / Up to 26.0 ipm 11.5 ipm Colour: 10 sec / Up to 9.0 ipm 6.0 ipm
Connectivity	USB 2.0, Ethernet, Wi-Fi IEEE 802.11 b/g/n, Wi-Fi Direct
Epson Connect	Epson iPrint, Epson Email Print, Remote Print Driver, Scan to Cloud
Other Mobile Solution	Apple AirPrint, Mopria Print Service
Warranty	2 years or 80,000 prints
Ink Model	008

BUSINESS INKJET PRINTER

Monochrome Single Function Printer A4



PDN

WORKFORCE PRO WF-M5399



Print Tech	PrecisionCore Printhead
Print Type	Print (Single Function)
Print Resolution	1,200 x 2,400 dpi
Print Speed	Black Draft Text - Memo, A4 Up to 34 ppm ISO 24734, A4 Simplex, Up to 25 ipm ISO 24734, A4 Duplex, Up to 16 ipm First Page Out Time, Approx. 4.8 sec
Paper Size	A6, A5, A4, B6, B5, Half Letter, 16K, Indian Legal, Letter, 8.5 x 13in, Legal, Photo Paper: 4 x 6", 16:9 Wide, 5 x 7", 8 x 10", Envelopes: #10, DL, C6, C5, C4
Power Consumption	Operating: 25 Watt Standby: 9.8 Watt Sleep: 1.1 Watt
Connectivity	USB 2.0, Ethernet, Wi-Fi (IEEE 802.11b/g/n), Wi-Fi Direct (up to 8 devices)
Epson Connect	Epson Smart Panel, Epson Email Print, Remote Print Driver
Other Mobile Solutions	Apple AirPrint, Mopria, Microsoft Universal Print, ChromeOS
Consumable	Up to 40,000 pages for black ink pack

Monochrome Multifunction Printer A4



PDN

WORKFORCE PRO WF-M5899



Print Tech	PrecisionCore Printhead
Print Type	Print (Single Function)
Print Resolution	1,200 x 2,400 dpi
Print Speed	Black Draft Text - Memo, A4 Up to 34 ppm ISO 24734, A4 Simplex, Up to 25 ipm ISO 24734, A4 Duplex, Up to 16 ipm First Page Out Time, Approx. 4.8 sec
Copy Speed	Up to 22 ipm (Black) - ISO 29183, A4, Simplex Up to 22 ipm (Black) - ISO 24735, A4, 1:1
Scan Speed	Monochrome 200 dpi: 5.0 sec / 30 ppm / 60 ipm Colour 200 dpi: 5.0 sec / 30 ppm / 60 ipm
Scan Resolution	1,200 x 2,400 dpi
Paper Size	A6, A5, A4, B6, B5, Half Letter, 16K, Indian Legal, Letter, 8.5 x 13in, Legal, Photo Paper: 4 x 6", 16:9 Wide, 5 x 7", 8 x 10", Envelopes: #10, DL, C6, C5, C4
Power Consumption	Operating: 25 Watt Standby: 9.8 Watt Sleep: 1.1 Watt
Connectivity	USB 2.0, Ethernet, Wi-Fi (IEEE 802.11b/g/n), Wi-Fi Direct (up to 8 devices)
Epson Connect	Epson Smart Panel, Epson Email Print, Remote Print Driver
Other Mobile Solutions	Apple AirPrint, Mopria, Microsoft Universal Print, ChromeOS
Consumable	Up to 40,000 pages for black ink pack

BUSINESS INKJET PRINTER

Multifunction Printer A4



PDN

WORKFORCE ENTERPRISE AM-C400



Print Tech	PrecisionCore Line Head Inkjet Technology
Print Type	Print, Scan, Copy with ADF
Print Resolution	600 x 2,400 dpi
Print Speed	Approx. 40 ipm / 40 ipm (Black/ Colour) - ISO 24734, A4, Simplex / Duplex Approx. 6.4 sec / 6.4 sec (Black/ Colour) - First Page Out Time
Copy Speed	Approx. 40 ipm (Black and Colour) - ISO 29183, A4, Flatbed Copy Speed Approx. 40 ipm (Black/ Colour) - ISO 24735, A4 (1:1, 1:2, 2:2), ADF Copy Speed
Scan Speed	3.9 sec / 50 ppm / 100 ipm Monochrome 200 dpi (Flatbed / ADF Simplex / ADF Duplex) 3.9 sec / 50 ppm / 100 ipm Colour 200 dpi (Flatbed / ADF Simplex / ADF Duplex)
Scan Resolution	600 x 600 dpi
Paper Size	A6, A5, A4, B6, B5, Half Letter, Executive, 16K, Letter, Legal, Custom Size: 85 x 140 mm – 215.9 x 297 mm
Power Consumption	Operating: 84 Watt, Standby: 39 Watt, Sleep: 0.9 Watt
Connectivity	USB 3.0, Ethernet, Wi-Fi (IEEE802.11b/g/n), Wi-Fi Direct (Max 8 devices)
Epson Connect	Epson Smart Panel, Epson Email Print, Remote Print Driver, Scan to Cloud
Other Mobile Solutions	Apple AirPrint, Mopria Print Service, ChromeOS, Microsoft Universal Print
Consumable	Up to 31,500 pages for black ink pack Up to 28,000 pages for colour ink pack

BUSINESS INKJET PRINTER



PDN

WORKFORCE ENTERPRISE AM-C550



Print Tech	PrecisionCore Line Head Inkjet Technology
Print Type	Print, Scan, Copy with ADF
Print Resolution	600 x 2,400 dpi
Print Speed	Approx. 55 ipm / 55 ipm (Black/ Colour) - ISO 24734, A4, Simplex / Duplex Approx. 5.9 sec / 5.9 sec (Black/ Colour) - First Page Out Time
Copy Speed	Approx. 55 ipm (Black and Colour) - ISO 29183, A4, Flatbed Copy Speed Approx. 55 ipm (Black/ Colour) - ISO 24735, A4 (1:1, 1:2, 2:2), ADF Copy Speed
Scan Speed	3.9 sec / 50 ppm / 100 ipm Monochrome 200 dpi (Flatbed / ADF Simplex / ADF Duplex) 3.9 sec / 50 ppm / 100 ipm Colour 200 dpi (Flatbed / ADF Simplex / ADF Duplex)
Scan Resolution	600 x 600 dpi
Paper Size	A6, A5, A4, B6, B5, Half Letter, Executive, 16K, Letter, Legal, Custom Size: 85 x 140 mm – 215.9 x 297 mm
Power Consumption	Operating: 86 Watt, Standby: 39 Watt, Sleep: 0.9 Watt
Connectivity	USB 3.0, Ethernet, Wi-Fi (IEEE802.11b/g/n), Wi-Fi Direct (Max 8 devices)
Epson Connect	Epson Smart Panel, Epson Email Print, Remote Print Driver, Scan to Cloud
Other Mobile Solutions	Apple AirPrint, Mopria Print Service, ChromeOS, Microsoft Universal Print
Consumable	Up to 31,500 pages for black ink pack Up to 28,000 pages for colour ink pack

BUSINESS INKJET PRINTER

Multifunction Printer A3



WORKFORCE PRO WF-C878R



Print Method	PrecisionCore™ Print Head
Max Resolution	4,800 x 1,200 dpi (with Variable-Sized Droplet Technology)
Min Droplet Size	4.6 pl
Print Speed	Max Draft Text - Memo (A4) : Approx. 35 ppm / 35 ppm (Black / Colour)
	ISO 24734, A4, Simplex : Approx. 25 ipm / 24 ipm (Black / Colour)
	ISO 24734, A4, Duplex : Approx. 17 ipm / 16 ipm (Black / Colour)
	ISO 24734.2, A3, Simplex : Approx. 13 ipm / 13 ipm (Black / Colour)
	ISO 24734.2, A3, Duplex : Approx. 11 ipm / 11 ipm (Black / Colour)
Copy Resolution	600 x 600 dpi
Copy Speed	ISO 29183, A4, Simplex (Flatbed) Approx. 23 ipm / 22 ipm (Black / Colour)
	ISO 24735, A4, Simplex (ADF) Approx. 21 ipm / 21 ipm (Black / Colour)
	ISO 24735, A4, Duplex (ADF) Approx. 15 ipm / 15 ipm (Black / Colour)
Scan Resolution	1,200 x 2,400 dpi
Scan Speed	[A4 Landscape, Flatbed / ADF Simplex / ADF Duplex]
	Monochrome 200 dpi: 4.0 sec / 25 ppm / 45 ipm
Memory	Colour 200 dpi: 5.0 sec / 25 ppm / 45 ipm
	3,072 MB



Total Nilai
TKDN + BMP
39.26%

WORKFORCE PRO WF-C879R



Print Method	PrecisionCore™ Print Head
Max Resolution	4,800 x 1,200 dpi (with Variable-Sized Droplet Technology)
Min Droplet Size	4.6 pl
Print Speed	Max Draft Text - Memo (A4) : Approx. 35 ppm / 35 ppm (Black / Colour)
	ISO 24734, A4, Simplex : Approx. 26 ipm / 25 ipm (Black / Colour)
	ISO 24734, A4, Duplex : Approx. 18 ipm / 17 ipm (Black / Colour)
	ISO 24734.2, A3, Simplex : Approx. 13 ipm / 13 ipm (Black / Colour)
	ISO 24734.2, A3, Duplex : Approx. 11 ipm / 11 ipm (Black / Colour)
Copy Resolution	600 x 600 dpi
Copy Speed	ISO 29183, A4, Simplex (Flatbed) : Approx. 24 ipm / 23 ipm (Black / Colour)
Scan Resolution	600 x 600 dpi
Scan Speed	[A4 Landscape, Flatbed / ADF Simplex / ADF Duplex]
	Monochrome 200 dpi: 3.7 sec / 50 ppm / 100 ipm
	Colour 200 dpi: 3.7 sec / 50 ppm / 100 ipm
Memory	4,224 MB



Total Nilai
TKDN + BMP
29.44%

BUSINESS INKJET PRINTER

NEW PRODUCT

WORKFORCE ENTERPRISE AM-C4000



- Print Tech** PrecisionCore Line Head Inkjet Technology
- Print Type** Print, Scan, Copy, Fax
- Print Resolution** 600 x 2,400 dpi
- Print Speed** Approx. 40 ipm / 40 ipm (Black/ Colour) - ISO 24734, A4, Simplex / Duplex
Approx. 23 ipm / 11 ipm (Black/ Colour) - ISO 24734.2, A3, Simplex / Duplex
Approx. 7.6 sec / 7.6 sec (Black/ Colour) - First Page Out Time
- Copy Speed** Approx. 40 ipm (Black and Colour) - ISO 29183, A4, Simplex (Flatbed)
Approx. 40 ipm / 40 ipm (Black/ Colour) - ISO 24735, A4, Simplex (ADF 1:1)
Approx. 40 ipm / 40 ipm (Black/ Colour) - ISO 24735, A4, Duplex (ADF 1:2 / 2:2)
- Scan Speed** A4 Landscape: 3.0 sec, A3: 4.0 sec, A4: 60 ppm / 120 ipm
A3: 30 ppm / -
- Scan Resolution** 600 x 600 dpi
- Paper Size** A3+, A3, A4, B5, A5, A6, 5x7", 4x6", Legal, 8.5x13", Letter, Envelopes: # 10, DL, C6, C5, C4
- Power Consumption** Operating: 110 Watt, Standby: 46 Watt, Sleep: 1.0 Watt
- Connectivity** USB 3.0, Ethernet, Ethernet, Direct Wi-Fi, Fax, Storage with HDD
- Epson Connect** Epson iPrint, Epson Email Print, Remote Print Driver, Scan to Cloud
- Other Mobile Solutions** Apple AirPrint, Mopria Print Service, Microsoft Universal Print
- Consumable** Up to 50,000 pages *for blank ink pack



Total Nilai TKDN + BMP
24.06%

NEW PRODUCT

WORKFORCE ENTERPRISE AM-C5000



- Print Tech** PrecisionCore Line Head Inkjet Technology
- Print Type** Print, Scan, Copy, Fax
- Print Resolution** 600 x 2,400 dpi
- Print Speed** Approx. 50 ipm / 50 ipm (Black/ Colour) - ISO 24734, A4, Simplex / Duplex
Approx. 30 ipm / 15 ipm (Black/ Colour) - ISO 24734.2, A3, Simplex / Duplex
Approx. 6.7 sec / 6.7 sec (Black/ Colour) - First Page Out Time
- Copy Speed** Approx. 50 ipm (Black and Colour) - ISO 29183, A4, Simplex (Flatbed)
Approx. 50 ipm / 50 ipm (Black/ Colour) - ISO 24735, A4, Simplex (ADF 1:1)
Approx. 50 ipm / 50 ipm (Black/ Colour) - ISO 24735, A4, Duplex (ADF 1:2 / 2:2)
- Scan Speed** A4 Landscape: 3.0 sec, A3: 4.0 sec, A4: 60 ppm / 120 ipm
A3: 30 ppm / -
- Scan Resolution** 600 x 600 dpi
- Paper Size** A3+, A3, A4, B5, A5, A6, 5x7", 4x6", Legal, 8.5x13", Letter, Envelopes: # 10, DL, C6, C5, C4
- Power Consumption** Operating: 110 Watt, Standby: 46 Watt, Sleep: 1.0 Watt
- Connectivity** USB 3.0, Ethernet, Ethernet, Direct Wi-Fi, Fax, Storage with HDD
- Epson Connect** Epson iPrint, Epson Email Print, Remote Print Driver, Scan to Cloud
- Other Mobile Solutions** Apple AirPrint, Mopria Print Service, Microsoft Universal Print
- Consumable** Up to 50,000 pages *for blank ink pack



Total Nilai TKDN + BMP
24.06%

BUSINESS INKJET PRINTER

Multifunction Printer A3

**NEW
PRODUCT**

WORKFORCE ENTERPRISE AM-C6000



Print Tech	PrecisionCore Line Head Inkjet Technology
Print Type	Print, Scan, Copy, Fax
Print Resolution	600 x 2,400 dpi
Print Speed	Approx. 60 ipm / 60 ipm (Black/ Colour) - ISO 24734, A4, Simplex / Duplex Approx. 36 ipm / 20 ipm (Black/ Colour) - ISO 24734.2, A3, Simplex / Duplex Approx. 6.1 sec / 6.1 sec (Black/ Colour) - First Page Out Time
Copy Speed	Approx. 60 ipm (Black and Colour) - ISO 29183, A4, Simplex (Flatbed) Approx. 60 ipm / 60 ipm (Black/ Colour) - ISO 24735, A4, Simplex (ADF 1:1) Approx. 60 ipm / 60 ipm (Black/ Colour) - ISO 24735, A4, Duplex (ADF 1:2 / 2:2)
Scan Speed	A4 Landscape: 3.0 sec, A3: 4.0 sec, A4: 60 ppm / 120 ipm A3: 30 ppm / -
Scan Resolution	600 x 600 dpi
Paper Size	A3+, A3, A4, B5, A5, A6, 5x7", 4x6", Legal, 8.5x13", Letter, Envelopes: #10, DL, C6, C5, C4
Power Consumption	Operating: 110 Watt, Standby: 46 Watt, Sleep: 1.0 Watt
Connectivity	USB 3.0, Ethernet, Ethernet, Direct Wi-Fi, Fax, Storage with HDD
Epson Connect	Epson iPrint, Epson Email Print, Remote Print Driver, Scan to Cloud
Other Mobile Solutions	Apple AirPrint, Mopria Print Service, Microsoft Universal Print
Consumable	Up to 50,000 pages* for blank ink pack



**Total Nilai
TKDN + BMP**

24.08%

WORKFORCE PRO WF-C20750



Print Tech	PrecisionCore™ Linehead Inkjet Technology
Print Type	Print, Scan, Copy, Fax
Print Resolution	600 x 2,400 dpi
Print Speed	Approx. 75 ipm / 75 ipm (Black / Colour) - ISO 24734, A4, Simplex / Duplex Approx. 45 ipm / 25.4 ipm (Black / Colour) - ISO 24734.2, A3, Simplex / Duplex Approx. 5.5 sec / 5.5 sec (Black / Colour) - ISO First Page Out Time
Copy Speed	Approx. 75 ipm (Black / Colour) - ISO 29183, A4, Simplex (Flatbed) Approx. 75 ipm (Black / Colour) - ISO 24735, A4, Simplex (ADF 1:1) Approx. 75 ipm (Black / Colour) - ISO 24735, A4, Duplex (ADF 1:2 / 2:2)
Scan Speed	3.7 sec / 60 ppm / 110 ppm (200 dpi; Mono / Colour)
Scan Resolution	600 x 1,200 dpi
Paper Size	A3+, A3, A4, B5, A5, A6, 5x7", 4x6", Legal, 8.5x13", Letter, Envelopes: #10, DL, C6, C5, C4
Power Consumption	Operating: 160 Watt Standby: 77 Watt Sleep: 1.4 Watt
Connectivity	USB 3.0, Ethernet (1000BASE-T/100BASE-TX/10BASE-T), Wi-Fi (IEEE 802.11b/g/n), Wi-Fi Direct, NFC
Epson Connect	Epson iPrint, Epson Email Print, Remote Print Driver, Scan to Cloud
Other Mobile Solutions	Google Cloud Print, Mopria Print Service
Consumable	Up to 100,000 pages* for black ink pack



**Total Nilai
TKDN + BMP**

23.55%

BUSINESS INKJET PRINTER

WORKFORCE PRO WF-C21000



Print Tech	PrecisionCore™ Linehead Inkjet Technology
Print Type	Print, Scan, Copy, Fax
Print Resolution	600 x 2,400 dpi
Print Speed	Approx. 100 ipm / 100 ipm (Black / Colour) – ISO 24734, A4, Simplex / Duplex Approx. 54 ipm / 36.3 ipm (Black / Colour) – ISO 24734.2, A3, Simplex / Duplex Approx. 5.0 sec / 5.0 sec (Black / Colour) – First Page Out Time
Copy Speed	Approx. 100 ipm (Black / Colour) – ISO 29183, A4, Simplex (Flatbed) Approx. 100 ipm (Black / Colour) – ISO 24735, A4, Simplex (ADF 1:1) Approx. 100 ipm (Black / Colour) – ISO 24735, A4, Duplex (ADF 1:2 / 2:2)
Scan Speed	3.7 sec / 60 ppm / 110 ppm (200 dpi; Mono / Colour)
Scan Resolution	600 x 1,200 dpi
Paper Size	A3+, A3, A4, B5, A5, A6, 5x7", 4x6", Legal, 8.5x13", Letter, Envelopes: #10, DL, C6, C5, C4
Power Consumption	Operating: 170 Watt Standby: 77 Watt Sleep: 1.4 Watt
Connectivity	USB 3.0, Ethernet (1000BASE-T/100BASE-TX/10BASE-T), Wi-Fi (IEEE 802.11b/g/n), Wi-Fi Direct, NFC
Epson Connect	Epson iPrint, Epson Email Print, Remote Print Driver, Scan to Cloud
Other Mobile Solutions	Apple AirPrint, Google Cloud Print, Mopria Print Service
Consumable	Up to 100,000 pages* for black ink pack



Total Nilai
TKDN + BMP

23.38%

Monochrome Multifunction Printer A3

WORKFORCE PRO WF-M21000



Print Tech	PrecisionCore™ Linehead Inkjet Technology
Print Type	Print, Scan, Copy, Fax
Print Resolution	600 x 2,400 dpi
Print Speed	Approx. 100 ipm / 100 ipm (Black) – ISO 24734, A4, Simplex / Duplex Approx. 54 ipm / 36.3 ipm (Black) – ISO 24734.2, A3, Simplex / Duplex Approx. 5.0 sec / 5.0 sec (Black) – First Page Out Time
Copy Speed	Approx. 100 ipm / 100 ipm (black) – ISO 29183, A4, Simplex (Flatbed) Approx. 100 ipm / 100 ipm (black) – ISO 24735, A4, Simplex (ADF, 1:1)
Scan Speed	3.7 sec / 60 ppm / 110 ppm (200 dpi; Mono / Colour)
Scan Resolution	600 x 600 dpi
Paper Size	A3+, A3, A4, B5, A5, A6, 5x7", 4x6", Legal, 8.5x13", Letter, Envelopes: #10, DL, C6, C5, C4
Power Consumption	Operating: 180 Watt Standby: 77 Watt Sleep: 1.4 Watt
Connectivity	USB 3.0, Ethernet (1000BASE-T/100BASE-TX/10BASE-T), Wi-Fi (IEEE 802.11b/g/n), Wi-Fi Direct, NFC
Epson Connect	Epson iPrint, Epson Email Print, Remote Print Driver, Scan to Cloud
Other Mobile Solutions	Google Cloud Print, Mopria Print Service
Consumable	Up to 100,000 pages* for black ink pack



Total Nilai
TKDN + BMP

23.36%

ENGINEERED FOR good

BANGGA KARYA ANAK BANGSA

PRINTER BISNIS MULTIFUNGSI DAN MESIN FOTOKOPI PERTAMA KARYA ANAK BANGSA

Dengan bangga kami mengumumkan bahwa Epson kini memproduksi printer bisnis multifungsi di Indonesia.* Dengan fasilitas pabrik yang lebih besar, kami berharap bisa meningkatkan produksi lokal, menciptakan lebih banyak lapangan kerja, dan mendukung masa depan yang berkelanjutan di Indonesia.

* Produk TKDN Epson bisa dilihat di website kami
<https://epson.co.id/tkdn>

Dirancang untuk kebaikan,
Dirancang untuk Indonesia



SATU SATUNYA MESIN FOTO KOPI TKDN

AM-C4000

AM-C5000

AM-C6000

Total Nilai
TKDN + BMP

Total Nilai
TKDN + BMP

Total Nilai
TKDN + BMP

24.06%

24.06%

24.08%

EPSON



BUSINESS INKJET PRINTER

T
T-Series

Surecolor Technical Series



PDN



SURECOLOR SC-T3730E

Max Print Width	24 inch wide (borderless)
Print Head	2.64 MicroTFP
Max Resolution	2401 dpi x 1200 dpi
Min Droplet Size	3.5 pl
Ink System	Ultrachrome XD3 pigment ink
Type	All Pigment Aqueous
Colours	C+M+Y+R+MK+PK (Black Matte/Photo Black)
Cartridge Size	110/350/700 ml
Paper Size	Spindle-less front loading single roll (Roll: 0.07mm – 0.8mm, Cut Sheet: 0.07mm – 0.8mm, Poster Board: 0.8mm – 1.5mm)
Print Speed	CAD A1: Plain Paper 300dpi x 600dpi : 21 sec 600dpi x 600dpi Line Draw: 27 sec Poster A1 : Plain Paper 300dpi x 600dpi EPSON Vivid : 21 sec
Media Thickness	Up to 1.5mm
Interface	USB 3.0, Ethernet (100BASE-TX/1000BASE-T), Wi-Fi (IEEE802.11b/g/n), Wi-Fi Direct (Simple AP, up to 8 device connections), USB Host Direct Print (PDF, TIFF, JPEG, HP-GL/2, HP RTL)
Memory	4GB, Optional 960GB SSD
Power Consumption	Operating : 75 W, Ready : 32 W, Sleep : 2 W, Standby : 0.3 W
Dimensions (W x D x H)	1365x499x975 mm
Weight	118 kg
Adobe Postscript 3	N/A



PDN



SURECOLOR SC-T3730DE

Max Print Width	24 inch wide (borderless)
Print Head	2.64 MicroTFP
Max Resolution	2401 dpi x 1200 dpi
Min Droplet Size	3.5 pl
Ink System	Ultrachrome XD3 pigment ink
Type	All Pigment Aqueous
Colours	C+M+Y+R+MK+PK (Black Matte/Photo Black)
Cartridge Size	110/350/700 ml
Paper Size	Two automatic roll switch (top-and front loading), (Roll: 0.07mm – 0.8mm, Cut Sheet: 0.07mm – 0.8mm, Poster Board: 0.8mm – 1.5mm)
Print Speed	CAD A1: Plain Paper 300dpi x 600dpi : 21 sec 600dpi x 600dpi Line Draw: 27 sec Poster A1 : Plain Paper 300dpi x 600dpi EPSON Vivid : 21 sec
Media Thickness	Up to 1.5mm
Interface	USB 3.0, Ethernet (100BASE-TX/1000BASE-T), Wi-Fi (IEEE802.11b/g/n), Wi-Fi Direct (Simple AP, up to 8 device connections), USB Host Direct Print (PDF, TIFF, JPEG, HP-GL/2, HP RTL)
Memory	4GB, Optional 960GB SSD
Power Consumption	Operating : 75 W, Ready : 32 W, Sleep : 2 W, Standby : 0.3 W
Dimensions (W x D x H)	1365x499x975 mm
Weight	118 kg
Adobe Postscript 3	N/A

BUSINESS INKJET PRINTER



PDN



SURECOLOR SC-T3730D

Max Print Width	24 inch wide (borderless)
Print Head	2.64 MicroTFP
Max Resolution	2401 dpi x 1200 dpi
Min Droplet Size	3.5 pl
Ink System	Ultrachrome XD3 pigment ink
Type	All Pigment Aqueous
Colours	C+M+Y+R+MK+PK (Black Matte/Photo Black)
Cartridge Size	110/350/700 ml
Paper Size	Two automatic roll switch (top-and front loading), (Roll: 0.07mm – 0.8mm, Cut Sheet: 0.07mm – 0.8mm, Poster Board: 0.8mm – 1.5mm)
Print Speed	CAD A1: Plain Paper 300dpi x 600dpi : 21 sec 600dpi x 600dpi Line Draw: 27 sec Poster A1 : Plain Paper 300dpi x 600dpi EPSON Vivid : 21 sec Up to 1.5mm
Media Thickness	Up to 1.5mm
Interface	USB 3.0, Ethernet (100BASE-TX/1000BASE-T), Wi-Fi (IEEE802.11b/g/n), Wi-Fi Direct (Simple AP, up to 8 device connections), USB Host Direct Print (PDF, TIFF, JPEG, HP-GL/2, HP RTL)
Memory	4GB, Optional 960GB SSD
Power Consumption	Operating : 75 W, Ready : 32 W, Sleep : 2 W, Standby : 0.3 W
Dimensions (W x D x H)	1365x499x975 mm
Weight	118 kg
Adobe Postscript 3	Available

SURECOLOR SC-T5730D



Max Print Width	36 inch wide (borderless)
Print Head	2.64 MicroTFP
Max Resolution	2401 dpi x 1200 dpi
Min Droplet Size	3.5 pl
Ink System	Ultrachrome XD3 pigment ink
Type	All Pigment Aqueous
Colours	C+M+Y+R+MK+PK (Black Matte/Photo Black)
Cartridge Size	110/350/700 ml
Paper Size	Two automatic roll switch (top-and front loading), (Roll: 0.07mm – 0.8mm, Cut Sheet: 0.07mm – 0.8mm, Poster Board: 0.8mm – 1.5mm)
Print Speed	CAD A1: Plain Paper 300dpi x 600dpi : 23 sec AO Size: 300dpi x 600dpi Line Draw : 28 sec Poster: Plain Paper 300dpi x 600dpi EPSON Vivid : 32 sec
Media Thickness	Up to 1.5mm
Interface	USB 3.0, Ethernet (100BASE-TX/1000BASE-T), Wi-Fi (IEEE802.11b/g/n), Wi-Fi Direct (Simple AP, up to 8 device connections), USB Host Direct Print (PDF, TIFF, JPEG, HP-GL/2, HP RTL)
Memory	4GB, Optional 960GB SSD
Power Consumption	Operating : 80 W, Ready : 32 W, Sleep : 2 W, Standby : 0.3 W
Dimensions (W x D x H)	1645x499x975 mm
Weight	136.8 kg
Adobe Postscript 3	Available

BUSINESS INKJET PRINTER

T
T-Series

Surecolor Technical Series



PDN



SURECOLOR SC-T5730DM

Max Print Width	36 inch wide (borderless)
Print Head	2.64 MicroTFP
Max Resolution	2401 dpi x 1200 dpi
Min Droplet Size	3.5 pl
Ink System	Ultrachrome XD3 pigment ink
Type	All Pigment Aqueous
Colours	C+M+Y+R+MK+PK (Black Matte/Photo Black)
Cartridge Size	110/350/700 ml
Paper Size	Two automatic roll switch (top-and front loading), (Roll: 0.07mm – 0.8mm, Cut Sheet: 0.07mm – 0.8mm, Poster Board: 0.8mm – 1.5mm)
Print Speed	CAD A1: Plain Paper 300dpi x 600dpi : 23 sec AO Size:300dpi x 600dpi Line Draw : 28 sec Poster: Plain Paper 300dpi x 600dpi EPSON Vivid : 32 sec
Media Thickness	Up to 1.5mm
Interface	USB 3.0, Ethernet (100BASE-TX/1000BASE-T), Wi-Fi (IEEE802.11b/g/n), Wi-Fi Direct (Simple AP, up to 8 device connections), USB Host Direct Print (PDF, TIFF, JPEG, HP-GL/2, HP RTL)
Memory	4GB, Optional 960GB SSD
Power Consumption	Operating : 80 W, Ready : 32 W, Sleep : 2 W, Standby : 0.3 W
Dimensions (W x D x H)	1645x499x975 mm
Weight	136.8 kg
Adobe Postscript 3	Available



PDN



SURECOLOR SC-T7730D

Max Print Width	44 inch wide (borderless)
Print Head	2.64 MicroTFP
Max Resolution	2400 dpi x 1200 dpi
Min Droplet Size	3.5 pl
Ink System	Ultrachrome XD3 pigment ink
Type	All Pigment Aqueous
Colours	C+M+Y+R+MK+PK (Black Matte/Photo Black)
Cartridge Size	110/350/700 ml
Paper Size	Two automatic roll switch (top-and front loading), (Roll: 0.07mm – 0.8mm, Cut Sheet: 0.07mm – 0.8mm, Poster Board: 0.8mm – 1.5mm)
Print Speed	CAD A1: Plain Paper 300dpi x 600dpi : 23 sec AO Size:300dpi x 600dpi Line Draw : 28 sec Poster: Plain Paper 300dpi x 600dpi EPSON Vivid : 32 sec BO Size: Plain Paper 300dpi x 600dpi EPSON Vivid : 46 sec
Media Thickness	Up to 1.5mm
Interface	USB 3.0, Ethernet (100BASE-TX/1000BASE-T), Wi-Fi (IEEE802.11b/g/n), Wi-Fi Direct (Simple AP, up to 8 device connections), USB Host Direct Print (PDF, TIFF, JPEG, HP-GL/2, HP RTL)
Memory	4GB, Optional 960GB SSD
Power Consumption	Operating : 70 W, Ready : 32 W, Sleep : 2 W, Standby : 0.3 W
Dimensions (W x D x H)	1848x499x975 mm
Weight	155 kg
Adobe Postscript 3	Available

BUSINESS INKJET PRINTER

SURECOLOR SC-T7730DM



Max Print Width	44 inch wide (borderless)
Print Head	2.64 MicroTFP
Max Resolution	2400 dpi x 1200 dpi
Min Droplet Size	3.5 pl
Ink System	Ultrachrome XD3 pigment ink
Type	All Pigment Aqueous
Colours	C+M+Y+R+MK+PK (Black Matte/Photo Black)
Cartridge Size	110/350/700 ml
Paper Size	Two automatic roll switch (top-and front loading), [Roll: 0.07mm – 0.8mm, Cut Sheet: 0.07mm – 0.8mm, Poster Board: 0.8mm – 1.5mm]
Print Speed	CAD A1: Plain Paper 300dpi x 600dpi : 23 sec AO Size: 300dpi x 600dpi Line Draw : 28 sec Poster: Plain Paper 300dpi x 600dpi EPSON Vivid : 32 sec BO Size: Plain Paper 300dpi x 600dpi EPSON Vivid : 46 sec"
Media Thickness	Up to 1.5mm
Interface	USB 3.0, Ethernet (100BASE-TX/1000BASE-T), Wi-Fi (IEEE802.11b/g/n), Wi-Fi Direct (Simple AP, up to 8 device connections), USB Host Direct Print (PDF, TIFF, JPEG, HP-GL/2, HP RTL)"
Memory	4GB, Optional 960GB SSD
Power Consumption	Operating : 70 W, Ready : 32 W, Sleep : 2 W, Standby : 0.3 W
Dimensions (W x D x H)	1848x499x975 mm
Weight	155 kg
Adobe Postscript 3	Available

SURECOLOR SC-T7730DL



Max Print Width	44 inch wide (borderless)
Print Head	2.64 MicroTFP
Max Resolution	2400 dpi x 1200 dpi
Min Droplet Size	3.5 pl
Ink System	Ultrachrome XD3 pigment ink
Type	All Pigment Aqueous
Colours	C+M+Y+R+MK+PK (Black Matte/Photo Black)
Cartridge Size	1000 ml
Paper Size	Two automatic roll switch (top-and front loading), [Roll: 0.07mm – 0.8mm, Cut Sheet: 0.07mm – 0.8mm, Poster Board: 0.8mm – 1.5mm]
Print Speed	CAD A1: Plain Paper 300dpi x 600dpi : 23 sec AO Size: 300dpi x 600dpi Line Draw : 28 sec Poster: Plain Paper 300dpi x 600dpi EPSON Vivid : 32 sec BO Size: Plain Paper 300dpi x 600dpi EPSON Vivid : 46 sec"
Media Thickness	Up to 1.5mm
Interface	USB 3.0, Ethernet (100BASE-TX/1000BASE-T), Wi-Fi (IEEE802.11b/g/n), Wi-Fi Direct (Simple AP, up to 8 device connections), USB Host Direct Print (PDF, TIFF, JPEG, HP-GL/2, HP RTL)"
Memory	4GB, Optional 960GB SSD
Power Consumption	Operating : 70 W, Ready : 32 W, Sleep : 2 W, Standby : 0.3 W
Dimensions (W x D x H)	1848x499x975 mm
Weight	155 kg
Adobe Postscript 3	Available

BUSINESS INKJET PRINTER

T-Series Surecolor Technical Series



SURECOLOR SC-T3130

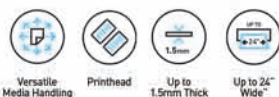

- Max Print Width: 24 inch wide (610 mm)
- Print Head: PrecisionCore TFP with VSDT and Auto Head Alignment
- Max Resolution: 2400 dpi x 1200 dpi
- Min Droplet Size: 4.0 pl
- Ink System: Epson Ultrachrome XD2 Pigment Ink
- Type: All-Pigment Aqueous
- Colours: C+M+Y+K
- Cartridge Size: CMY 26/50 ml, K 50/80 ml
- Print Speed (A1 sheet): CAD A1: 34 sec
- Paper Size: Single roll top loaded spindle, 2" core, 0.05-0.21 mm thick, 329-610 mm wide, 110 mm max diameter, 3kg max weight
- Interface: USB 3.0 & Ethernet 10Base-T/100Base-TX/1000Base-T, Wi-Fi, Wi-Fi Direct, Air Print
- OS Compatibility: Windows 10 / 8.1 / 8 / 7 / Vista / XP, Mac OSx10.6.8 or later
- Memory: 1 GB
- Power Consumption: 28W Operating, 8W Standby, 1.6W Sleep
- Dimensions (W x D x H): 970 x 505 x 230
- Weight: 38 kg



Total Nilai TKDN + BMP
36.24%

SURECOLOR SC-T3130N



- Max Print Width: 24 inch wide (610 mm)
- Print Head: Precision Core TFP with VSDT and Auto Head Alignment
- Max Resolution: 2400 dpi x 1200 dpi
- Min Droplet Size: 4.0pl
- Ink System: Epson Ultrachrome XD2 Pigment Ink
- Type: All-Pigment Aqueous
- Colours: C+M+Y+K
- Cartridge Size: CMY 26/50 ml, K50/80 ml
- Print Speed (A1 sheet): CAD A1:34 sec
- Paper Size: Single roll top loaded spindle, 2" core, 0.05-0.21 mm thick, 329-610mm wide, 110 mm max diameter, 3 kg max weight
- Interface: USB 3.0 & Ethernet 10Base-T/100Base-TX/1000Base-T, Wi-Fi, Wi-Fi Direct, Air Print
- OS Compatibility: Windows 10 / 8.1 / 8 / 7 / Vista / XP, Mac OSx10.6.8 or later
- Memory: 1 GB
- Power Consumption: 28W Operating, 8W Standby, 1.6 W Sleep
- Dimensions (W x D x H): 970 x 505 x 230 cm
- Weight: 27 kg



Total Nilai TKDN + BMP
33.42%

BUSINESS INKJET PRINTER

SURECOLOR SC-T3130X

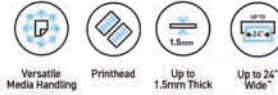

**Total Nilai
TKDN + BMP
34.60%**

- Max Print Width** 24 inch wide (610 mm)
- Print Head** Precision Core TFP with VSDT and Auto Head Alignment
- Max Resolution** 2400 dpi x 1200 dpi
- Min Droplet Size** 3.8pl
- Ink System** Epson Ultrachrome XD2 Pigment Ink
- Type** All-Pigment Aqueous
- Colours** C+M+Y+K
- Cartridge Size** 140 ml
- Print Speed** CAD A1:34 sec
- Paper Size** Single roll top loaded spindle, 2" core, 0.05-0.21 mm thick, 329-610mm wide, 110 mm max diameter, 3 kg max weight
- Interface** USB 3.0 & Ethernet
10Base-T/100Base-TX/1000Base-T, Wi-Fi, Wi-Fi Direct, Air Print
- OS Compatibility** Windows 10/ 8.1 / 8 / 7 / Vista / XP, Mac OSx10.6.8 or later
- Memory** 1 GB
- Power Consumption** 28W Operating, 8W Standby, 1.6 W Sleep
- Dimensions (W x D x H)** 970 x 577 x 245 cm
- Weight** 29 kg

SURECOLOR SC-T3130M

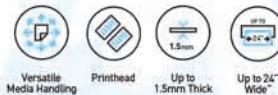

**Total Nilai
TKDN + BMP
34.23%**

- Max Print Width** 24 inch wide (610 mm)
- Print Head** Precision Core TFP with VSDT and Auto Head Alignment
- Max Resolution** 2400 dpi x 1200 dpi
- Min Droplet Size** 4.0pl
- Ink System** Epson Ultrachrome XD2 Pigment Ink
- Type** All-Pigment Aqueous
- Colours** C+M+Y+K
- Cartridge Size** CMY 26/50 ml, K 50/80 ml
- Scan Technology** Contact Image Sensor (CIS) with RGB filters
- Light Source** Dual Low Angle / RGB LED
- Feed System** Sheet pass-through
- Max Resolution** 600 dpi
- Max Scan Speed** 11.43 cm/s or 4.5 ips (Colour)
19.05 cm/s or 7.5 ips (Mono)
- Max Copy Speed** 38 sec per A1 sheet mono
44 sec per A1 sheet colour
- Print Speed (A1 sheet)** CAD A1:34 sec
- Paper Size** Single roll top loaded spindle, 2" core, 0.05-0.21 mm thick, 329-610mm wide, 110 mm max diameter, 3 kg max weight
- Interface** USB 3.0 & Ethernet
10Base-T/100Base-TX/1000Base-T, Wi-Fi, Wi-Fi Direct, Air Print
- OS Compatibility** Windows 10/ 8.1 / 8 / 7 / Vista / XP, Mac OSx10.6.8 or later
- Memory** 1 GB+8GB*For scanner data processing
- Power Consumption** 24W Operating, 11W Standby, 2.0 W Sleep
- Dimensions (W x D x H)** 970 x 292 x 230
- Weight** 44.4 kg

BUSINESS INKJET PRINTER

T-Series Surecolor Technical Series

SURECOLOR SC-T3435



Total Nilai
TKDN + BMP

35.99%

Max Print Width 24 inch wide (610 mm)
Print Head Precision Core TFP with VSDT and Auto Head Alignment
Max Resolution 2400 dpi x 1200 dpi
Min Droplet Size 4.0pl
Ink System Epson Ultrachrome XD2 Pigment Ink
Type All-Pigment Aqueous
Colours C+M+Y+K
Cartridge Size CMYK, 100 ml/350 ml/700 ml
Scan Integration Available connect with Business Inkjet Printer Scanner :

WF-C17590, WF-C20590, WF-C20600, WF-C20750,
WF-C21000, WF-M20590
WF-R8591, WF-C869R, WF-C878R, WF-C879R,
Print Speed (A1 sheet) CAD A1:25 sec
Paper Size Single roll top loaded spindle, 2/3" core, 0.08-0.3 mm thick, 254-610mm wide, 170 mm max diameter, 8 kg max weight
Interface USB 3.0 & Ethernet 10Base-T/100Base-TX/1000Base-T, Wi-Fi, Wi-Fi Direct, Air Print
OS Compatibility Windows 10/ 8.1 / 8 / 7 / Vista / XP, Mac OSx10.6.8 or later
Memory 1 GB
Power Consumption 34W Operating, 13W Standby, 1.3 Sleep
Dimensions (W x D x H) 1080 x 1060 x 750 cm (with stand)
Weight 64 kg

SURECOLOR SC-T5130



Total Nilai
TKDN + BMP

36.99%

Max Print Width 36 inch wide (914 mm)
Print Head PrecisionCore TFP with VSDT and Auto Head Alignment
Max Resolution 2,400 dpi x 1,200 dpi
Min Droplet Size 4.0pl
Ink System Epson Ultrachrome® XD2
Type All-Pigment Aqueous
Colours C+M+Y+K
Cartridge Size CMY 26/50 ml, K 50/80 ml
Print Speed (A3 Sheet) CAD A3: 31 sec
Paper Size Single roll top loaded spindle, 2" core, 0.05-0.21 mm thick, 329-910 mm wide, 110 mm max diameter, 5kg max weight
Interface USB 3.0 & Ethernet 10Base-T / 100Base-TX / 1000Base-T, Wi-Fi, Wi-Fi Direct, Air Print
OS Compatibility Windows 10 / 8.1 / 8 / 7 / Vista / XP, Mac OS x 10.6.8 or later
Memory 1 GB
Power Consumption 28W Operating, 8W Standby, 1.6W Sleep
Dimensions (W x D x H) 1,268 x 913 x 696 mm
Weight 46 kg

BUSINESS INKJET PRINTER

SURECOLOR SC-T5130M

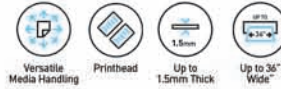

Max Print Width	36 inch wide (914 mm)
Print Head	Precision Core TFP with VSDT and Auto Head Alignment
Max Resolution	2400 dpi x 1200 dpi
Min Droplet Size	4.0pl
Ink System	Epson Ultrachrome XD2 Pigment Ink
Type	All-Pigment Aqueous
Colours	C+M+Y+K
Cartridge Size	CMY 26/50 ml, K 50/80 ml
Scan Technology	Contact Image Sensor (CIS) with RGB filters
Light Source	Dual Low Angle / RGB LED
Feed System	Sheet pass-through
Max Resolution	600 dpi
Max Scan Speed	11.43 cm/s or 4.5 ips (Colour) 19.05 cm/s or 7.5 ips (Mono)
Max Copy Speed	38 sec per A1 sheet mono 44 sec per A1 sheet colour
Print Speed (A1 sheet)	CAD A1:31 sec
Paper Size	Single roll top loaded spindle, 2" core, 0.05-0.21 mm thick, 297-914mm wide, 110 mm max diameter, 3 kg max weight
Interface	USB 3.0 & Ethernet 10Base-T/100Base-TX/1000Base-T, Wi-Fi, Wi-Fi Direct, Air Print
OS Compatibility	Windows 10/8.1/8/7/Vista/XP, Mac OSx10.6.8 or later
Memory	1 GB+8GB*For scanner data processing
Power Consumption	26W Operating, 12W Standby, 2.0 Sleep
Dimensions (W x D x H)	1268 x 975 x 696 cm (with stand)
Weight	54.8 kg



Total Nilai
TKDN + BMP
37.14%

SURECOLOR SC-T5435



Max Print Width	36 inch wide (914 mm)
Print Head	Precision Core TFP with VSDT and Auto Head Alignment
Max Resolution	2400 dpi x 1200 dpi
Min Droplet Size	4.0pl
Ink System	Epson Ultrachrome XD2 Pigment Ink
Type	All-Pigment Aqueous
Colours	C+M+Y+K
Cartridge Size	CMYK, 100 ml/350 ml/700 ml
Scan Integration	Available connect with Business Inkjet Printer Scanner :
Print Speed (A1 sheet)	WF-C17590, WF-C20590, WF-C20600, WF-C20750, WF-C21000, WF-M20590 WF-R8591, WF-C869R, WF-C878R, WF-C879R, CAD A1:22 sec
Paper Size	Single roll top loaded spindle, 2/3" core, 0.08-0.3 mm thick, 254-914mm wide, 170 mm max diameter, 12 kg max weight
Interface	USB 3.0 & Ethernet 10Base-T/100Base-TX/1000Base-T, Wi-Fi, Wi-Fi Direct, Air Print
OS Compatibility	Windows 10/8.1/8/7/Vista/XP, Mac OSx10.6.8 or later
Memory	1 GB
Power Consumption	38W Operating, 13W Standby, 1.3 Sleep
Dimensions (W x D x H)	1385 x 1070 x 750 cm (with stand)
Weight	76 kg



Total Nilai
TKDN + BMP
36.32%

ENGINEERED FOR good

EPSON

BANGGA KARYA ANAK BANGSA

Komitmen Epson mendukung industri lokal:
Mencapai nilai optimal Tingkat Komponen
Dalam Negeri



SC-T5435

Total Nilai
TKDN + BMP

36.32%



BUSINESS INKJET PRINTER

SURECOLOR SC-T5430M



Total Nilai
TKDN + BMP

33.77%

Max Print Width	36 inch wide (914 mm)
Print Head	PrecisionCore TFP with VSDT and Auto Head Alignment
Max Resolution	2400 dpi x 1200 dpi
Min Droplet Size	4.0 pl
Ink System	Epson Ultrachrome® XD2
Type	All-Pigment Aqueous
Colours	C+M+Y+K
Cartridge Size	CMYK 110/350ml
Scan Technology	Contact Image Sensor (CIS) with RGB filters
Light Source	Dual Low Angle
Feed System	Sheet pass-through
Max Resolution	600 dpi
Max Scan Speed	11.43 cm/s or 4.5 ips (Colour) 19.05 cm/s or 7.5 ips (Mono)
Max Copy Speed	38 sec per A1 sheet mono 44 sec per A1 sheet colour
Print Speed (A1 Sheet)	CAD A1 : 22 sec
Paper Size	Single roll top loaded spindle, 2" core, 3" core for plain paper, 0.08 to 0.3 mm thick, 254-914 mm wide, 170 mm max diameter, max weight 12kg
Interface	USB 3.0 & Ethernet 10Base-T / 100Base-TX / 1000Base-T, Wi-Fi, Wi-Fi Direct, Air Print
OS Compatibility	Windows 10 / 8.1 / 8 / 7 / Vista / XP, Mac OS x 10.6.8 or later
Memory	1 GB
Power Consumption	Operating 38W, Standby 13W, Sleep 1.6W
Dimensions (W x D x H)	1,385 x 966 x 1,060 mm
Weight	89 kg

BUSINESS INKJET PRINTER

Business Inkjet Printer Consumable

MATERIAL DESCRIPTION

	WF-C5390 & WF-C5890 C13T11F100 STANDARD CAPACITY BLACK INK PACK C13T11F200 STANDARD CAPACITY CYAN INK PACK C13T11F300 STANDARD CAPACITY MAGENTA INK PACK C13T11F400 STANDARD CAPACITY YELLOW INK PACK C13T11H100 HIGH CAPACITY BLACK INK PACK
	WF-C579R C13T01C100 WF-C579R BK / Standard C13T01C200 WF-C579R C / Standard C13T01C300 WF-C579R M / Standard C13T01C400 WF-C579R Y / Standard C13T01D100 WF-C579R BK / Large C13T01D200 WF-C579R C / Large C13T01D300 WF-C579R M / Large C13T01D400 WF-C579R Y / Large
	L6550/L6580/L15160/L15180/M15180 C13T06G199 008 CAHILL/CAVANI, BLACK 127ML (EIN) C13T06G299 008 CAHILL/CAVANI, CYAN 70ML (EIN) C13T06G399 008 CAHILL/CAVANI, MAGENTA 70ML (EIN) C13T06G499 008 CAHILL/CAVANI, YELLOW 70ML (EIN)
	WF-C878R & WF-C879R C13T05A100 WF-C878R/C879R INK PACK, BLACK/STD C13T05A200 WF-C878R/C879R INK PACK, CYAN/STD C13T05A300 WF-C878R/C879R INK PACK, MAGENTA/STD C13T05A400 WF-C878R/C879R INK PACK, YELLOW/STD C13T05B100 WF-C878R/C879R INK PACK, BLACK/LARGE C13T05B200 WF-C878R/C879R INK PACK, CYAN/LARGE C13T05B300 WF-C878R/C879R INK PACK, MAGENTA/LARGE C13T05B400 WF-C878R/C879R INK PACK, YELLOW/LARGE
	AM-C4000 C13T08F100 INK CARTRIDGE, BLACK C13T08F200 INK CARTRIDGE, CYAN C13T08F300 INK CARTRIDGE, MAGENTA C13T08F400 INK CARTRIDGE, YELLOW
	AM-C5000/6000 C14T08E100 INK CARTRIDGE, BLACK C14T08E200 INK CARTRIDGE, CYAN C14T08E300 INK CARTRIDGE, MAGENTA C14T08E400 INK CARTRIDGE, YELLOW
	AM-C400 C13T08L100 T08L INK, BLACK, 40PPM (A4) C13T08L200 T08L INK, CYAN, 40PPM (A4) C13T08L300 T08L INK, MAGENTA, 40PPM (A4) C13T08L400 T08L INK, YELLOW, 40PPM (A4)
	AM-C550 C13T08M100 T08L INK, BLACK, 55PPM (A4) C13T08M200 T08L INK, CYAN, 55PPM (A4) C13T08M300 T08L INK, MAGENTA, 55PPM (A4) C13T08M400 T08L INK, YELLOW, 55PPM (A4)
	WF-C20750 C13T02S100 INK CARTRIDGE, BK, 75PPM C13T02S200 INK CARTRIDGE, C, 75PPM C13T02S300 INK CARTRIDGE, M, 75PPM C13T02S400 INK CARTRIDGE, Y, 75PPM
	WF-C21000 C13T02Y100 INK CARTRIDGE, BK, 100PPM C13T02Y200 INK CARTRIDGE, C, 100PPM C13T02Y300 INK CARTRIDGE, M, 100PPM C13T02Y400 INK CARTRIDGE, Y, 100PPM
	WF-M21000 C13T04Q100 BLACK INK, MONO LIJ
	WF-M5899 & M5399 C13T11V100 WF-M5399/M5899, BK/Standard C13T11W100 WF-M5399/M5899, BK/Large C13T11Y100 WF-M5399/M5899, BK/XL

BUSINESS INKJET PRINTER

Business Inkjet Printer Consumable

	MATERIAL CODE	DESCRIPTION
	T5430/T3430 C13T41D200 C13T41D300 C13T41D400 C13T41D500 C13T41Q200 C13T41Q300 C13T41Q400 C13T41Q500	CYAN 350ML MAGENTA 350ML YELLOW 350ML BLACK 350ML CYAN 110ML MAGENTA 110ML YELLOW 110ML BLACK 110ML
		
	C-T3130/SC-T3130N/SC-T5130/ SC-T3130M/SC-T5130M C13T40A100 C13T40A200 C13T40A300 C13T40A400 C13T40B100 C13T40B200 C13T40B300 C13T40B400	BLACK INK CARTRIDGE 50ML CYAN INK CARTRIDGE 26ML MAGENTA INK CARTRIDGE 26ML YELLOW INK CARTRIDGE 26ML BLACK INK CARTRIDGE 80ML CYAN INK CARTRIDGE 50ML MAGENTA INK CARTRIDGE 50ML YELLOW INK CARTRIDGE 50ML
		
	T3130X C13T49K100 C13T49K200 C13T49K300 C13T49K400	BLACK 140ML CYAN 140ML MAGENTA 140ML YELLOW 140ML
	T3270/T5270/T7270 C13T692100 C13T692200 C13T692300 C13T692400 C13T692500 C13T693100 C13T693200 C13T693300 C13T693400 C13T693500 C13T694100 C13T694200 C13T694300 C13T694400 C13T694500	PHOTOBLACK 110ML CYAN 110ML MAGENTA 110ML YELLOW 110ML MATTE BLACK 110ML PHOTOBLACK 350ML CYAN 350ML MAGENTA 350ML YELLOW 350ML MATTE BLACK 350ML PHOTOBLACK 700ML CYAN 700ML MAGENTA 700ML YELLOW 700ML MATTE BLACK 700ML
		
		
	SC-T3435/SC-T5435 C13T41Q500 C13T41Q200 C13T41Q300 C13T41Q400 C13T41D500 C13T41D200 C13T41D300 C13T41D400 C13T41C500 C13T41C200 C13T41C300 C13T41C400	BLACK INK CARTRIDGE 110ML CYAN INK CARTRIDGE 110ML MAGENTA INK CARTRIDGE 110ML YELLOW INK CARTRIDGE 110ML BLACK INK CARTRIDGE 350ML CYAN INK CARTRIDGE 350ML MAGENTA INK CARTRIDGE 350ML YELLOW INK CARTRIDGE 350ML BLACK INK CARTRIDGE 700ML CYAN INK CARTRIDGE 700ML MAGENTA INK CARTRIDGE 700ML YELLOW INK CARTRIDGE 700ML
		
	SC-T3730/5730/7730/D C13T51F200 C13T51F800 C13T51F300 C13T51F100 C13T51FF00 C13T51F400 C13T50Y200 C13T50Y800 C13T50Y300 C13T50Y100 C13T50YF00 C13T50Y400 C13T50R200 C13T50R800 C13T50R300 C13T50R100 C13T50RF00 C13T50R400	CYAN IC (110 ML) MATTE BLACK IC (110ML) MAGENTA IC (110ML) PHOTOBLACK IC (110ML) RED IC (110ML) YELLOW IC (110ML) CYAN IC (350ML) MATTEBLACK IC (350ML) MAGENTA IC (350ML) INK PHOTOBLACK IC (350ML) RED IC (350ML) YELLOW IC (350ML) CYAN IC (700ML) MATTEBLACK IC (700ML) MAGENTA IC (700ML) PHOTOBLACK IC (700ML) RED IC (700ML) YELLOW IC (700ML)
		

COMMERCIAL & INDUSTRIAL PRINTER

1
TEXTILE
PRINTER BRAND
YEAR 2022

ISC Worldwide Quarterly Industrial Printer Tracker, #222A



1
SIGNAGE
PRINTER BRAND
YEAR 2022

ISC Worldwide Quarterly Industrial Printer Tracker, #222A



1
GRAPHIC
PRINTER BRAND
YEAR 2022

ISC Worldwide Quarterly Industrial Printer Tracker, #222A



COMMERCIAL & INDUSTRIAL PRINTER

MENGAPA MEMILIH EPSON PRINTER ?

Epson large format printer memastikan hasil warna yang luar biasa sehingga menjadi pilihan yang tepat untuk mendukung berbagai bisnis Anda mulai dari Advertising, fashion, retail dan photography.

Print head Epson Micro Piezo™

Print head Epson Micro Piezo™ Thin Film Piezo yang khusus dikembangkan untuk printer Large Format Epson, memiliki performa dan daya tahan tinggi dengan 360 micro-fine nozzles untuk setiap warnanya, memberikan bentuk dot (titik) yang sempurna. Teknologi ini menggunakan Variable-Sized Droplet Technology (VSDT) untuk memproduksi butiran tinta dalam berbagai ukuran sampai sekecil 3.5 pico-litres (pl) yang mampu menghemat waktu mencetak dan mengoptimalkan kualitas. Print head juga dilengkapi dengan Ink-Repelling Coating, lapisan pada permukaan print head untuk mengurangi kemungkinan terjadinya penyumbatan pada tinta. Teknologi printhead yang berupa lapisan tipis unik piezo (TFP) yang memadukan teknologi komponen superior dengan teknologi fabrikasi Micro-Electro-Mechanical-System (MEMS) yang berpresisi tinggi. Hasilnya adalah kecepatan cetak dan mutu gambar yang tinggi untuk pemakaian di berbagai kegiatan usaha dan industri.



Epson LUT (Look Up Table) Technology

Dengan teknologi Epson LUT, hasil cetak printer format besar Epson menampilkan gradasi halus, butiran tampak berkurang dan warna tidak dapat berubah, menjadikan hasil cetak indah dan gambar berdefinisi tinggi.

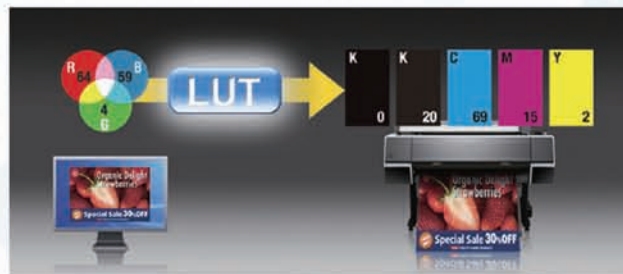

COMMERCIAL & INDUSTRIAL PRINTER

P Series

SurePress Label Printers

SUREPRESS SP-L6534VW



Print Technology	PrecisionCore linehead inkjet technology
Max Print Resolution	600 x 1200 dpi
Substrate Width	80mm to 340mm
Substrate Type	Adhesive Paper, Adhesive Film, Single Layer Paper, Single Layer Film
Substrate Thickness	80 to 320 microns
Substrate Treatment	Corona Treatment, Static Ionizer, UV Curing Lamp
Unwinder Capacity	600mm dia / 100kg weight / 1,000m length
Ink Type	UV Curable Inks
Ink Cartridges	Black, Cyan, Magenta, Yellow, Digital Varnish, White, Storage liquid
Print Speed	Productivity Mode: 50m/min, Standard Mode: 30m/min, High Density Mode: 15m/min, Reverse White Mode: 7.6m/min
Dimensions	4250 (W) x 2290 (D) x 2520 (H) mm
Weight	2640 kg

Available with Orange Ink

SUREPRESS SP-L4733AW



Model No	SurePress L 4733AW
Printing Technology	Epson MicroPiezo inkjet technology
Ink Type	SurePress AQ Ink T4 (SurePress AQ)
Ink cartridge	Black, Uncoated Black, Cyan, Magenta, Yellow, Orange, Green, Over print liquid, Moisture liquid (AW model only: White, Storage liquid)
Image size	315.2mm x 914.4mm
Print speed	Up to 8.2 meter per minute *
Substrate thickness	80 to 320 µm
Substrate width	80 to 334mm Adjustable to support any width in this range
Substrate support	Standard self adhesive label substrate, Semi gloss, gloss and matte paper stock, BOPP, PET, Yupo and pre laminated film
Unwinder capacity (Max.)	100kg weight / 1,000m length, 600mm diameter with 76mm (3") inner core
Dimensions of Press (WxDxH)	3950 x 1,910mm x 2,020mm
Dimensions of Press and Rewinder (WxDxH)	5100 x 1,910mm x 2,020mm
Weight of Press	Approximately 1870kg(TBD) including rewriter
Weight of Rewinder	Approximately 180kg
Network connectivity	Ethernet 1000 base T or higher is recommended
Power requirements	Input voltage range: Rated voltage 10% (180 220V) Rated voltage: AC (3 phases 3 lines) 200V
Temperature (Operating)	18 - 28 derajat celcius
Relative Humidity (Operating)	35 - 55% (no condensation)
Max. sound level (Operating)	75dB or less (excluding the alarm sound)

ENGINEERED FOR good

EPSON



**GO
BIG**

**WITH OUTSTANDING
DIGITAL PRINTS FOR
EVERY PURPOSE**

**Vivid
inks**

Consistent
vibrant colours

**More
possibilities**

Digitally print using a
range of processes on
almost any materials

**Reliable
performance**

with durable
PrecisionCore
printhead technology

**Decentralising
operations**

Manage print jobs
remotely via network
connectivity

COMMERCIAL & INDUSTRIAL PRINTER

F Series | Surecolor Fabric Series

SURECOLOR SC-F2230



Max Print Width
Print Head
Max Resolution
Min Droplet Size
Ink System
Colours
Cartridge Size
Print Speed



Standard & Medium Grooved Platen: 356 x 406 mm
PrecisionCore MicroTFP Printhead
1200 dpi x 1200 dpi

12.8 pl
UltraChrome DG2 Ink
Cyan, Magenta, Yellow, Black, White
800ml

Cotton Garment Material

Drying: 170°C, 45 seconds (For dark T-shirt) /
Fixing: 170°C, 45 seconds (For dark T-shirt / light
T-shirt)

Polyester Garment Material (For dark T-shirt)

Drying: 130°C, 60 seconds / Fixing: 130°C, 90 seconds

Polyester Garment Material (For light T-shirt)

Drying: 130°C, 60 seconds / Fixing: 130°C, 30 seconds
Hi-Speed USB 2.0 x 2 (For PC x1, for USB flash
memory x 1), 1000 Base-T

Interface

OS Compatibility
Memory

Power Consumption

Dimension
Weight

Windows & Mac Compatible

1GB

Operating: Approx. 46W, Ready: Approx. 30W, Sleep:

Approx. 7.0W, Standby: Approx. 0.3W

981 W x 499 H x 1,361 mm D

94.5 kg

SURECOLOR SC-F1030



Max Print Width
Print Head
Max Resolution
Min Droplet Size
Ink System
Colours
Cartridge Size
Print Speed

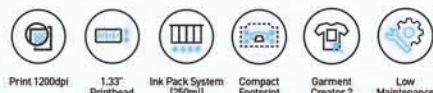

Small Platen: 254 x 305 mm
PrecisionCore MicroTFP Printhead
2400 dpi x 1200 dpi

12.8 pl
UltraChrome DG2 Ink
Cyan, Magenta, Yellow, Black, White
250ml

Cotton Garment Material

Drying: 170°C, 45 seconds (For dark T-shirt) /
Fixing: 170°C, 45 seconds (For dark T-shirt / light
T-shirt)

Polyester Garment Material (For dark T-shirt)

Drying: 130°C, 60 seconds / Fixing: 130°C, 90 seconds

Polyester Garment Material (For light T-shirt)

Drying: 130°C, 60 seconds / Fixing: 130°C, 30 seconds
Super-Speed USB 3.0 x 1 (For PC x1), Hi-Speed USB2.0
x 1 (USB flash memory x 1), 1000 Base-T/100

Interface

OS Compatibility
Memory

Power Consumption

Dimension
Weight

Base-TX/10 Base-T, IEEE802.11b/g/n/a/ac/k/v/r

Windows & Mac Compatible

1GB

Operating: Approx. 40W, Ready: Approx. 20W, Sleep:

Approx. 6.0W, Standby: Approx. 0.2W

899 W x 426 H x 99 mm D

72 kg

COMMERCIAL & INDUSTRIAL PRINTER

SURECOLOR SC-F3030



Max Print Width	406 x 508 mm (using optional Large Platen)
Print Head	PrecisionCore Micro TFP print head x 2
Max Resolution	1,200 x 1,200 dp
Min Droplet Size	12.1 pl
Ink System	Epson Ultrachrome® DG
Colours	CYMKWW
Cartridge Size	1500ml
Print Speed	Fast 14s (Colour Only), 26s (White + Colour) Production: 21s (Colour Only), 40s (White + Colour) Quality: 36s (Colour Only), 47s (White + Colour) High Quality : 48s (Colour only) , 70s (White + Colour)
Interface	Rear High Speed USB 2.0 & Ethernet 100Base/T1000 Base- T/100 Base Front panel USB for file storage & Uploading (FAT32 format)
OS Compatibility	Windows & Mac Compatible.
Memory	4GB
Power Consumption	168 W Operating, 111W Ready, 20W Sleep

SURECOLOR SC-F130



Paper Width	A4, LTR, Legal
Printhead	PrecisionCore Micro TFP Printhead
Max. Resolution	600 x 1,200 dpi
Ink Type	Dye Sublimation Transfer Ink
Colours	Cyan, Magenta, Yellow, Black
Paper Path	Friction Feed
Print Speed	65 seconds (Default)
Interfaces	Hi-Speed USB *2, Ethernet (10BASE-T / 100BASE-TX), Wi-Fi (IEEE 802.11 b/g/n)
Memory	132 Kbyte (Input Buffer Memory)
Voltage	AC 220 - 240V (withstand voltage AC 400V)
W x D x H	375x503x187mm
Frequency	50/60 Hz
Power Consumption	Operating: Aprox. 13W Ready: Aprox. 4.1W Sleep: Aprox. 0.7W
Weight	Aprox. 4.6 kg (without ink bottle)
Warranty	1 Year/6000 sheets, Whichever comes first

COMMERCIAL & INDUSTRIAL PRINTER

F Series Surecolor Fabric Series

SURECOLOR SC-F530

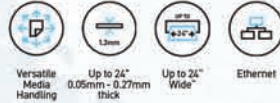

Printer Width
Print Head
Maximum Resolution
Ink System
Colours
Print Speed
Interface
OS Compatibility
Memory
Power Consumption
Dimension
Weight

24"
PrecisionCore TFP Printhead
2400 x 1200 dpi
Epson Genuine Dye-Sublimation Ink
Cyan, Magenta, Yellow, Black
Production (2 pass), For Fabric: Up to 62 sec / 21 m² (600 x 1200 dpi), Production (7 pass): For Fabric & Rigid: Up to 208 sec / 7.5 m² (1200 x 1200 dpi), Production (12 pass), For Fabric & Rigid: Up to 350 sec / 4.5 m² (2400 x 1200 dpi)
USB 2.0 Hi-speed, Ethernet 100BASE-TX / 1000BASE-T
Windows 10 / 8.1 / 8 / 7 / Vista / XP, Mac OSx10.6.8 or later
1 GB
Operating: Approx. 22W, Ready: Approx. 8W
Sleep: Approx. 1.6W, Power Off (Stand by): Approx. 0.2W
Storage (W x H x D): 970 mm x 245 mm x 577 mm
Printing (W x H x D): 970 mm x 245 mm x 811 mm
29kg



Total Nilai
TKDN + BMP
34.18%

SURECOLOR SC-F531



Max. Print Width
Printhead
Max. Resolution
Min. Droplet Size
Ink Type
Colours
Cartridge Size
Print Speed
Interface
Memory
Power Consumption
Dimensions
Weight

24 inch
PrecisionCore TFP[™] Printhead
2,400 x 1,200 dpi
4.0pl
Epson Genuine Dye-SUBlimat ion Ink
4 Colours - Cyan, Flourescent Pink, Flourescent Yellow
Black
Cyan, Magenta, Yellow: 26ml, 50ml ; Black: 50ml , 80ml
Production (2 pass), For Fabric: Up to 62 sec / 21 m² (600 x 1200 dpi) ; Production (7 pass): For Fabric & Rigid: Up to 208 sec / 7.5 m² (1200 x 1200 dpi)
Production (12 pass), For Fabric & Rigid: Up to 350 sec / 4.5 m² (2400 x 1200 dpi)
Super-Speed USB
100BASE-TX / 1000BASE-T / IEEE802.11 b/g/n
1 GB
Ready: Approx. 8W; Sleep: Approx. 1.6 W
Operating: Approx. 28W; Power Off: Approx 0.2W
970 x 505 x 230 (WxDxH)
29 kg (without ink cartridges)



Total Nilai
TKDN + BMP
34.67%

COMMERCIAL & INDUSTRIAL PRINTER

SURECOLOR SC-F7270



Max Print Width	64 inches (1625.6mm)
Print Head	10 channel PrecisionCore™ TFP with VSDT
Max Resolution	720 dpi x 1440 dpi
Ink System	Epson Ultrachrome® DS
Type	Dye Sublimation
Colours	C+Y+M+Bk / C+Y+M+HDK
Cartridge Size	4 x 1.5L
Print Speed	Normal Mode Draft: 58.9 m ² /hr 1 Pass 360 x 720dpi Normal Mode Fast Production: 30.3m ² /hr; 2 Pass 720 x 720 dpi; Normal Mode Production 1: 22.2m ² /hr 3 Pass 720 x 720dpi; HQ Mode Production 1: 13.8m ² /hr 4 Pass 720 x 720dpi
Paper Size	Thickness 0.08-1mm (75 gsm or greater) Width 300-1625.6 mm
Interface	High Speed USB 2.0 & Ethernet 100Base-T/ 1000Base-T
OS Compatibility	Windows 10 / 8.1 / 8 / 7 (32/64bit) or later (64bit required for Edge Print); Mac OS X 10.7 Lion or later
Memory	512 MB Main + 128MB Network
Power Consumption	460W Operating (heater on), 10W Sleep (heater off, 1000Base-T Interface)
Dimensions (W x D x H)	2620 x 1013 x 1314 mm (W x D x H)
Weight	274kg

SURECOLOR SC-F6430/H



Max Print Width	44 inch
Print Head	PrecisionCore MicroTFP Printhead
Max Resolution	600 x 1,200 dpi
Ink System	SC-F6430 UltraChrome DS Ink (Cyan, Magenta, Yellow, High Density Black)
Type	SC-F6430H UltraChrome DS 6 Ink (Cyan, Magenta, Yellow, High Density Black, Light Cyan, Light Magenta, Fluorescent Yellow, Fluorescent Pink, Orange, Violet)
Ink Capacity	Dye Sublimation
Refill	4 x 1.5L Continuous Ink Supply System (CISS)
Paper Size	1.6 L Thickness Up to 0.5 mm Width 254 mm to 1,118 mm (10" to 44")
Interface	Super Speed USB, 100BASE-TX/1000BASE-T
Memory	1 GB
Power Consumption	80W Operating, 36W Ready, 19W Sleep
Weight	SC-F6430 With Take Up Reel: Approx. 133 kg Without Take Up Reel: Approx. 120 kg
	SC-F6430H With Take Up Reel: Approx. 140 kg Without Take Up Reel: Approx. 127 kg

COMMERCIAL & INDUSTRIAL PRINTER

F Series Surecolor Fabric Series

SURECOLOR SC-F9530



Max Print Width 64 inch (1625.6 mm)
 Print Head DUAL Epson PrecisionCore™ TFP
 Max Resolution 720 dpi x 1440 dpi
 Min Droplet Size 4 pl
 Ink System Epson Ultrachrome® DS
 Type Epson Sublimation
 Colours Dual CYMHD
 Cartridge Size 8 / 10 x 1.5L Continuous Ink Supply System (CISS)
 Refill 1.1L CYMHDk
 Print Speed



4c Fast Fabric Production:
 360 x 720 dpi (2 Pass) 60.1 m2/hr
 4c Standard Fabric Production :
 720 x 720 dpi (3 Pass) 44.1 m2/hr
 4c HQ Standard Rigid Production :
 720 x 720 dpi (6 Pass) 20.7 m2/hr
 6c Standard Fabric Production (F9430H only):
 720 x 1440 dpi (6 Pass) 21.9m2/hr
 6c HQ Standard Rigid Production (F9430H only):
 720 x 1440 dpi (12 Pass) 10.6m2/hr
 300 - 1626 mm wide x 250 mm diameter, 2"/ 3" core
 High Speed USB 2.0
 Ethernet 100Base-T / 1000Base-T
 Windows 10, 8/8.1, 7 SP1 64bit or later
 512 MB Main + 128 MB Network
 570W Operating / Standby 340W / 14W Sleep
 (1000BASE-T)

SURECOLOR SC-F9530H



Max Print Width 64 inch (1625.6 mm)
 Print Head DUAL Epson PrecisionCore™ TFP
 Max Resolution 720 dpi x 1440 dpi
 Min Droplet Size 4 pl
 Ink System Epson Ultrachrome® DS6
 Type Epson Sublimation
 Colours Dual CYMHDk + Single Fp & Fy (F9430H)
 Cartridge Size 8 / 10 x 1.5L Continuous Ink Supply System (CISS)
 Refill 1.1L CYMHDk
 Print Speed



4c Fast Fabric Production:
 360 x 720 dpi (2 Pass) 60.1 m2/hr
 4c Standard Fabric Production :
 720 x 720 dpi (3 Pass) 44.1 m2/hr
 4c HQ Standard Rigid Production :
 720 x 720 dpi (6 Pass) 20.7 m2/hr
 6c Standard Fabric Production (F9430H only):
 720 x 1440 dpi (6 Pass) 21.9m2/hr
 6c HQ Standard Rigid Production (F9430H only):
 720 x 1440 dpi (12 Pass) 10.6m2/hr
 300 - 1626 mm wide x 250 mm diameter, 2"/ 3" core
 High Speed USB 2.0
 Ethernet 100Base-T / 1000Base-T
 Windows 10, 8/8.1, 7 SP1 64bit or later
 512 MB Main + 128 MB Network
 570W Operating / Standby 340W / 14W Sleep
 (1000BASE-T)

COMMERCIAL & INDUSTRIAL PRINTER

SURECOLOR SC-F11030

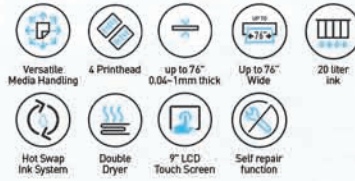

Max Media Width 76 inch (1950mm)
 Print Head FOUR 4.7" Epson PrecisionCore™ TFP
 Nozzle Configuration 800 x 4 per head/colour
 Maximum Resolution 1200 x 1200dpi
 Min Droplet Size Dye Sublimation Epson Ultrachrome® DS
 Colours CYM +HDk
 Supply DUAL Continuous Ink Supply System (CISS) with auto hot-swap
 Refills Choice of 3L or 10L box type PERFORMANCE
 Max Quality 1200 x 1200dpi*4 (9 Pass) 29.3m²/hr
 Size 300-1950mm wide, 250mm max diameter/
 60Kg max weight
 Thickness 0.04-1mm
 Control Panel 9" Colour Touch LCD
 Interface High Speed USB 3.0, Ethernet 1000Base-T
 Memory 155GB
 Power Supply 2 x 16A, 240V, 50/60 Hz AC
 Power Consumption 3.9kW Operating / 221W Sleep / 9.6W Off
 Dimensions (W x D x H) 1303mm x 2886mm x 4607mm, 683Kg
 Printer (without media holders or ink)
 CISS: 877 x 556 x 541mm, 53kg (no ink)
 Operational Space (W x D x H) 5,6 x 3,3 x 2,0m recommended
 Weight 736kg (without ink)

SURECOLOR SC-F11030H

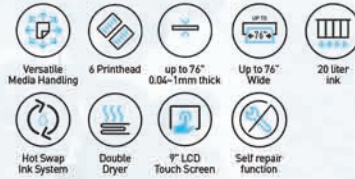

Max Media Width 76 inch (1950mm)
 Print Head six 4.7" Epson Precision Core tm TFP
 Colours CMY + HDk + Fluorescent Pink Fluorescent Yellow or
 Light Magenta Light Cyan
 Dimensions (W x D x H) 196" x 52" x 75" (4,978 mm x 1,303 mm x 1,886 mm)
 Weight Approx. 767 kg (Without ink cartridges)
 Printing Dimensions (W x H x D) 5,008 x 1,886 x 1,303 mm
 Power Consumption
 Operating: Approx. 4.4kw
 Ready: Approx. 230W
 Sleep: Approx. 230W
 Power Off (Stand by): Approx. 9.6 W

COMMERCIAL & INDUSTRIAL PRINTER

Direct-To-Fabric Printer

ML-8000



Print Technology
Number of Print Head
Max Resolution

Print Speed

Power Consumption
Network
Dimensions

Weight

Print
Speed

PrecisionCore Inkjet Technology

8

1,200 x 1,200 dpi (Pigment), 1,200 x 600 dpi
(Reactive, Acid, Disperse)

Print Speed Square : 312 (300 x 600 dpi, 1 pass)1 /
3,122

(300 x 600 dpi, 1 pass)²

Print Speed Linear : 208 (300 x 600 dpi, 1 pass)1 / 634

(300 x 600 dpi, 1 pass)²

12kVA

USB 3.0 Ethernet 1000BASE-T

Printer: 3,700 (W) x 2,690 (D) x 1,830 (H) mm

(146 x 106 x 72 in), Ink rack (with 10L ink) : 880 (W) x

960 (D) x 790 (H) mm(35 x 38 x 31 in)

Printer : Approx. 2,150 kg (4,740 lb), Ink rack :

Approx. 110 kg (243 lb, not including ink)

Typical printing speed

312 sqm/h (300x600) dpi, 1 pass

162 sqm/h (600x600) dpi, 2 pass

Monna Lisa Evo Tre 16



Print Technology
Number of Print Head
Max Resolution
Print Speed

Humidity
Dimension

Electrical
Weight
Print Speed

PrecisionCore Inkjet Technology
16

1,200 x 1,200 dpi

Draft 1 404 m²/h

Draft 2 270 m²/h

Production 1 221 m²/h

Production 2 171 m²/h

Production 3 135 m²/h

High Quality 1 103 m²/h

High Quality 2 79 m²/h

High Quality 3 63 m²/h

35-80% RH (Condensation)

Printing Machine: Approx. 4,660 (W) x 2,390 (D) x 1.940
(H) mm

Control Box: 620 (W) x 1,220 (D) x 2.070 (H) mm

Ink Rack: 1,240 (W) x 1,300 (D) x 1,220 (H) mm

Printing Machine: AC 3 Phase 400V 50A (50/60 Hz)

4,650 kg

Maximum Printing Speed

434 sqm/h (300x600) dpi, 1 pass

Typical Printing Speed

239 sqm/h (600x600) dpi, 2 pass

161 sqm/h (900x600) dpi, 3 pass

COMMERCIAL & INDUSTRIAL PRINTER

Monna Lisa ML32000



Print Technology
Number of Print Head
Max Resolution
Print Speed

PrecisionCore Inkjet Technology
32

1,200 x 1,200 dpi
Maximum Printing Speed (m2/h)
697 (300 x 600 dpi, 1 Pass)

Typical Printing Speed 1 (m2/h)

423 (600 x 600 dpi, 2 Pass)

Typical Printing Speed 2 (m2/h)

305 (900 x 600 dpi, 3 Pass)

Maximum Printing Speed (sq ft/hr)

7,502 (300 x 600 dpi, 1 Pass)

Typical Printing Speed 1 (sq ft/hr)

4,553 (600 x 600 dpi, 2 Pass)

Typical Printing Speed 2 (sq ft/hr)

3,283 (900 x 600 dpi, 3 Pass)

Humidity
Dimension

35 - 80% RH (no condensation)

Printing Machine: Approx. 4,610 (W) x 2,500 (D) x

2,070 (H) mm

Control Box: 660 (W) x 1,500 (D) x 2,290 (H) mm

Working Area: 8,110 (W) x 5,400 (D) x 2,290 (H) mm

Electrical
Weight

400V, 3 phase + Neutral + Earth

Printer: Approx 3,900 kg (8,598 lb)

Control box: Approx 400 kg (882 lb)

Ink Rack: Approx 240 kg (529 lb) (exc ink)

Power Consumption
Temperature

20.7 kVa

Operating: 20°C-30°C (68°F-86°F)

Monna Lisa ML64000



Print Technology
Number of Print Head
Max Resolution
Print Speed

PrecisionCore Inkjet Technology
64

1,200 x 1,200 dpi

Typical Printing Speed 1 (m2/h)

740 (600 x 600 dpi, 2 Pass)

Typical Printing Speed 2 (m2/h)

533 (900 x 600 dpi, 3 Pass)

Typical Printing Speed 1 (sq ft/hr)

7,965 (600 x 600 dpi, 2 Pass)

Typical Printing Speed 2 (sq ft/hr)

5,737 (900 x 600 dpi, 3 Pass)

Humidity
Dimension

40 - 60% (no condensation)

Printing Machine: Approx. 6,510 (W) x 4,960 (D) x

2,530 (H) mm

Working Area: 8,500 (W) x 7,270 (D) x 2,640 (H) mm

AC 220 - 240V (withstand voltage AC 400V)

Electrical
Weight

Printer: Approx 7,000 kg (15,432 lb)

Control box: Approx 700 kg (1,543 lb)

Ink Rack: Approx 300 kg (661 lb) (exc ink)

Temperature

Operating: 20°C-30°C (68°F-86°F)

COMMERCIAL & INDUSTRIAL PRINTER

P Surecolor Photographic Series

SURECOLOR SC-P8530D



Technology	PrecisionCore Inkjet Technology, Variable-Sized Droplet Technology
Max Resolution	2,400 x 1,200 dpi
Min Droplet Size	3.5pl
Ink System	UltraChrome Pro 6 Ink
Ink Capacity	350, 700 ml
Colours	Cyan, Magenta, Yellow, Gray, Photo Black, Matte Black
Interface	SuperSpeed USB, 100BASE-TX /1000BASE-T/IEEE802.11b/g/n/ac, USB memory stick
Power Consumption	Operating: Approx. 70W, Ready: Approx. 32W, Sleep: Approx. 2.0W, Standby: Approx. 0.3W
Dimension (WxHxD)	1,848 x 975 x 829 mm
Weight	Approx. 155 kg

SURECOLOR SC-P703



Max Print Wide Technology	13 inch wide On-demand ink jet (piezo electric), Variable-Sized Droplet Technology
Max Resolution	5760x1440 dpi
Min Droplet Size	1.5pl
Ink System	UltraChrome PRO10 ink
Colours	Cyan, Vivid Magenta, Photo Black, Matte Black, Gray, Light Gray, Yellow, Vivid Light Magenta, Light Cyan, Violet
Interface	Wired Connection: Super-Speed USB, 10BASE-T/100BASE-TX, Wireless Connection: Wi-Fi 4
Power Consumption	22 W Operating/ 1.1 W Sleep
Dimension (WxDxH)	Close: 515x368x185 mm, Open: 515x769x420 mm
Weight	Main Unit: Approx. 12.6kg (without ink cartridge)



SURECOLOR SC-P903



Max Print Wide Technology	17 inch wide On-demand ink jet (piezo electric), Variable-Sized Droplet Technology
Max Resolution	5760x1440 dpi
Min Droplet Size	1.5pl
Ink System	UltraChrome PRO10 ink
Colours	Cyan, Vivid Magenta, Photo Black, Matte Black, Gray, Light Gray, Yellow, Vivid Light Magenta, Light Cyan, Violet
Interface	Wired Connection: Super-Speed USB, 10BASE-T/100BASE-TX, Wireless Connection: Wi-Fi 4
Power Consumption	24 W Operating/ 1.1 W Sleep
Dimension (WxDxH)	Close: 615x368x199 mm, Open: 615x905x520 mm
Weight	Main Unit: Approx. 14.8kg (without ink cartridge), Option roll unit: 3.1kg



COMMERCIAL & INDUSTRIAL PRINTER

SURECOLOR SC-P5330



- Max Print Width 17 inch (432 mm)
- Print Head PrecisionCore® TFP
- Max Resolution 2880 dpi x 1440 dpi
- Min Droplet Size 3.5 pl
- Ink System Epson Ultrachrome® HDX
- Type Aqueous all-pigment
- Colours 11 (Configurable with Light Light Black OR Violet)
- Cartridge Size 200 ml
- Print Speed (A2 sheet) Draft: 360 dpi x 360 dpi 0.5 minutes
Normal: 360 dpi x 720 dpi 0.8 minutes
Fine: 720 dpi x 720 dpi 1.8 minutes
Super Fine: 720 dpi x 1440 dpi 3.6 minutes
Super Photo: 2880 dpi x 1440 dpi 7 minutes
- Paper Size 8" x 10" (203 x 254 mm) - A2+ (432 x 610 mm) sheets, 203-432 mm wide x 150 mm diameter 3" core / 103 mm diameter 2" core rolls
- Interface High Speed USB 2.0, Ethernet 10Base-T / 100Base-TX / 1000Base-T
- OS Compatibility Mac OS X 10.6.8 or later, Windows 10, 8/8.1, 7, Vista, & Win XP SP1
- Memory 256 MB Main and 128 MB Network
- Power Consumption 52W Operating / Standby 20W / 5W Sleep (1000BASE-T)
- Dimensions (W x D x H) 863 x 766 x 405 mm (Sheet feed & output tray closed)
- Weight 52kg (no ink)

SURECOLOR SC-P6000



- Print Head PrecisionCore™ TFP printhead, Epson Variable-Sized Droplet Technology
- Max Resolution 2880x1440 dpi
- Min Droplet Size 3.5 pl
- Ink System Epson UltraChrome HD
- Colours Cyan, Photo Black, Matte Black, Vivid Magenta, Yellow, Light Cyan, Vivid Light Magenta, Light Black, Light Light Black
- Paper Path Friction Feed
- Roll Dimensions 254mm-610mm, 2inch-core/3inch-core
2inch-core: Max 103mm / 3inch-core: Max 150mm
- Paper Size (w) and Thickness 254mm (10") - 610mm (24"): Roll paper 254mm (10") - 610mm (24"): Cut Sheet 0.08-1.50mm
- Borderless 254mm (10in.), 300mm (11.8in.), 329mm (13in.), 406mm (16in.), 432mm (17in.), 515mm (20.3in.), 594mm (23in.), 610mm (24in.)
- Interface Hi-Speed USB, 10BASE-T/100BASE-T/1000BASE-T
- Dimension (W x D x H) 1,356 x 667 x 1,218 mm
- Weight Approx. 101kg

COMMERCIAL & INDUSTRIAL PRINTER

P Surecolor Photographic Series

SURECOLOR SC-P20530

Versatile
Media HandlingUp to
1.5mm
ThickUp to 17"
Wide

Ethernet



Max Print Width	17 inch (432 mm)
Print Head	PrecisionCore MicroTFP Printhead
Max Resolution	2000 dpi x 1200 dpi
Min Droplet Size	3.5 pl
Ink System	UltraChrome PRO 12 Ink
Type	Pigment Ink
Colours	12 [Configurable with Light Light Black OR Violet]
Cartridge Size	1,600ml
Print Speed [A2 sheet]	Plain Paper Draft Mode: Approx. 122 m2h
Paper Size	254 (10") - 1,626 (64") mm
Interface	SuperSpeed USB, 100BASE-TX / 1000BASE-T [Option]
OS Compatibility	Windows XP, Vista, 7, 8, 8.1 (32/64bit) or later Macintosh Mac OS X 10.6.8 or later
Memory	Physical 6GB (Printer H/W)
Power Consumption	95W Operating / Standby 0.5W / 2.2W Sleep
Dimensions [W x D x H]	2,740 x 760 x 1,145 mm
Weight	224 kg

SURECOLOR SC-P9530

Versatile
Media HandlingUp to
1.5mm
ThickUp to 44"
WideBorderless
PrintingEasy
Maintenance

Max Print Width	44 inch
Print Head	Micro TFP Printhead
Max Resolution	2400 dpi x 1200 dpi
Min Droplet Size	3.5 pl
Ink System	Ultrachrome® Pro12 Pigment Ink
Colours	12
Paper Handling	Roll Paper / Friction Feed
Print Speed	219 sec (Level 1) 285 sec (Default) Premium Glossy
Printer Interface	Photo Paper 170 gsm B0 size/ISO USB Interface (Hi-Speed USB/USB, 100 BASE - TX / 1000 BASE - T
OS Compatibility	Mac OS X 10.6.8 or later, Windows XP / Vista / 7 / 8 / 8.1 (32/64bit) or later
Memory	2 GB
Power Consumption	Operating : Approx 110 W Ready : Approx 32 W Sleep : Approx 3.4 W Power Off (Stand by) : Approx 0.3 W

COMMERCIAL & INDUSTRIAL PRINTER

SURECOLOR SC-P6530E



Max Print Width 24 Inch
 Print Head PrecisionCore Micro TFP printhead
 Max Resolution 2400 dpl x 1200 dpl
 Min Droplet Size 3.5pl
 Ink System Ultra Chrome Pro 6 Ink
 Colours 6
 Paper Handling Roll Paper / Friction Head
 Print Speed 111 Sec, A1 Size Premium Glossy
 Printer Interface 1000 BASE-T
 OS Compatibility Mac OS X 10.6.8 or later, Mac os 11 or later
 Memory 4 GB
 Power Consumption Operating approx 75W
 Ready approx 32W
 Sleep approx 2W
 Standby approx 0.3W

SURECOLOR SC-P8000



Print Head PrecisionCore™ TFP printhead,
 Epson Variable-Sized Droplet Technology
 Max Resolution 2880x1440 dpi
 Min Droplet Size 3.5 pl
 Ink System Epson UltraChrome HD
 Colours Cyan, Photo Black, Matte Black, Vivid Magenta, Yellow, Light Cyan, Vivid Light Magenta, Light Black, Light Light Black
 Paper Path Friction Feed
 Roll Dimensions 254mm-1118mm, 2inch-core/ 3inch-core
 2inch-core: Max 103mm/ 3inch-core: Max 150mm
 Paper Size (w) and Thickness 254mm (10") - 1118mm (44"): Roll paper 210mm (A4) - 1118mm (44"): Cut Sheet 0.08-1.50mm
 Borderless 728mm(29in.), 841mm(A0/33in.), 914mm(36in.), 1118mm (44in.) 728mm (29in.), 841mm A0/33in.), 914mm (36in.), 1118mm (44in.)
 Interface Hi-Speed USB, 10BASE-T/100BASE-T/1000BASE-T
 Dimension (W x D x H) 1,864 x 667 x 1,218 mm
 Weight Approx. 135kg

SURECOLOR SC-P7530



Max Print Width 24 inch
 Print Head Micro TFP Printhead
 Max Resolution 2400 dpi x 1200 dpi
 Min Droplet Size 3.5 pl
 Ink System Ultrachrome® Pro12 Pigment Ink
 Colours 12
 Paper Handling Roll Paper / Friction Feed
 Print Speed 97 sec (Level 1) 122 sec (Default) Premium Glossy
 Photo Paper 170 gsm A1 size/ISO
 Super Speed USB, 100 BASE - TX / 1000 BASE - T
 OS Compatibility Mac OS X 10.6.8 or later, Windows XP / Vista / 7 / 8 / 8.1 (32/64bit) or later
 Memory 2 GB
 Power Consumption Operating : Approx 85 W
 Ready : Approx 32 W
 Sleep : Approx 3.4 W
 Power Off (Stand by) : Approx 0.3 W

COMMERCIAL & INDUSTRIAL PRINTER

S S-Series

Surecolor Signage Series

SURECOLOR SC-R5030L



Max Print Width	64 inch
Technology	PrecisionCore inkjet technology
Max Resolution	1,200 x 2,400 dpi With 600 x 600 dpi 8 Half Tone layers
Print Speed	Banner Fast Production Vinyl, Paper & Wall Covering - 21m ² /h (600 x 1200dpi 6 pass) Banner Production Vinyl, Paper & Wall Covering - 15.1m ² /h (1200 x 1200dpi 9 pass) Textile Production - 9.5m ² /h (1200 x 1200dpi 14 pass) Film Production - 5.2m ² /h (1200 x 2400dpi 26 pass)
Ink Type	Resin ink
Colours	Cyan, Magenta, Yellow, Black, Light Cyan, Light Magenta +Optimizer+Mainenance Liquid @ 3000ml
Ink Capacity	USB (Hi-Speed USB), 100BASE-TX/1000BASE-T
Interface	2 GB
Memory	4.6kW Operating/ 220W Ready/ 46W Sleep/ 1.1W Power Off (Stand by)
Power Consumption	Printing : 2,949mm x 1,045mm x 1,774mm Stowed : 2,949mm x 1,045mm x 1,605mm
Dimensions (W x D x H)	Weight
Weight	449kg

SURECOLOR SC-V7000



Epson 1st UV Flatbed Printer

Technology	MicroPiezo Inkjet Technology (Technology 1) Variable-Sized Droplet Technology (Technology 2)
Print Head	MicroPiezo Printhead
Nozzle Configuration	11,520 nozzles (180 nozzles x 8 lines x 8 head)
Max Resolution	720 x 1,440 dpi
Print Speed	Colour High Speed: 360 x 720 dpi, with speed 43.1 m/h
Curing Method	LED-UV type
Ink Type	UV Curable Ink
Colours	Cyan, Magenta, Yellow, Black, Light Cyan, Light Magenta, Gray, Red, White, Varnish
Ink Capacity	1,000 ml (Ink Bottle)
Max Printing Area	Max. 2,500 x 1,250 mm
Max Media Size	Max. 2,500 x 1,250 mm
Interface	Super-Speed USB (Type-B)
Power Consumption	Operating: Approx. 4.8kW
Dimensions (W x D x H)	4,635mm x 2,768mm x 1,730mm
Weight	1,370 kg (With ink cartridges)

COMMERCIAL & INDUSTRIAL PRINTER

SURECOLOR SC-V1030



Technology	MicroPiezo Inkjet Technology (Technology 1) Variable-Sized Droplet Technology (Technology 2)
Print Head	MicroPiezo Printhead
Nozzle Configuration	1,440 nozzles (180 nozzles x 8 lines x 1 head)
Max Resolution	1,440 x 1,440 dpi
Print Speed	720 x 720 dpi, 12 Pass (Colour): 0.89m ² /h 1,440 x 720 dpi, 16 Pass (White): 0.65m ² /h
Curing Method	LED-UV type
Ink Type	UV Curable Ink
Colours	Black, Cyan, Magenta, Yellow, White, Varnish
Ink Capacity	140 ml (Ink Supply Unit)
Max Printing Area	Max. 212 x 299 mm
Max Media Size	Max. 210 x 297 mm
Interface	SuperSpeed USB (Compatible with the USB 3.0 Specification), 100BASE-TX / 1000BASE-T / IEEE802.11b/g/n/az/ac
OS Compatibility	Windows 7 (32/64) or later Mac OS 10.6.8 or later
Dimensions (W x D x H)	Printing: 699 x 426 (Cover Closed) / 942 (Cover Opened) x 699 mm Stowed: 699 x 426 x 699 mm
Weight	59 kg (With ink cartridges)

SD-10

Digital Colour Spectrophotometer



Technology	Spectroscopic Device
Spectral Range	400 - 700nm
Sampling Interval	Colour Measurement
Photometric Range	10 nm (Interpolation by software)
Light Source	LED (Including UV)
Measurement Conditions	M0: Including UV light component, ISO 13655:2017 measurement condition M0 M1e: D50 - Including UV light component, measurement conditions equivalent to ISO 13655:2017 measurement condition M1 [Measurement conditions held with a radiant power at all wavelengths from 400 to 700 nm, and power ratios in the 300 to 400 nm and 400 to 500 nm regions similar to D50] M2: Without UV, ISO 13655:2017 measurement condition M2
Calibration	White reference built in the sensor cover
Scan Length	400mm
Interfaces	USB Type-C, USB 2.0 Full-Speed BLE Bluetooth Low Energy
Dimensions (W x D x H)	35 x 80 x 80 mm (Shutter Closed) 35 x 80 x 77.6 mm (Shutter Opened)
Weight	Approx. 190g

COMMERCIAL & INDUSTRIAL PRINTER

S Surecolor Signage Series

SURECOLOR SC-S40670



Max Print Width	64 inch
Print Head	PrecisionCore™ TFP® Printhead
Max Resolution	1440 dpi x 1440 dpi
Min Droplet Size	4.2 pl
Ink System	Epson Ultrachrome® GS3
Type	Eco-Solvent Based
Colours	CMYK
Cartridge Size	4 x 700 ml
Print Speed	Draft: 58.4m ² /hr (360 dpi x 720 dpi 1 pass) Billboard: 29.4m ² /hr (720 dpi x 720 dpi 2 pass) Banner: 16.6m ² /hr (720 dpi x 720 dpi 4 pass) Vinyl: 10.5m ² /hr (720 dpi x 1440 dpi 6 pass) Film: 3.5m ² /hr (1440 dpi x 1440 dpi 16 pass)
Paper Size	Single Roll, 2" or 3" core, 250 mm max outer diameter & 45kg max weight Sizing: 300 to 1626 mm wide, 500 mm min length, 1 mm max thickness
Interface	Hi-Speed USB 2.0, 100BASE-TX / 1000BASE-T
RIP Compatibility	Supplied with Epson Edge Print and supports a wide range of 3rd party applications
Memory	512 MB
Power Consumption	480W Operating / 330W Ready/ 12W Sleep
Dimensions (W x D x H)	2,620 x 1,338 x 880 mm (W x H x D)
Weight	279kg

SURECOLOR SC-S60670



Max Print Width	64 inch
Print Head	Dual PrecisionCore™ TFP® Printhead
Max Resolution	1440 dpi x 1440 dpi
Min Droplet Size	4.2 pl
Ink System	Epson Ultrachrome® GS3
Type	Eco-Solvent Based
Colours	CMYK
Cartridge Size	2 x 4 x 700 ml
Print Speed	Max Speed: 95.3m ² /hr (360 dpi x 720 dpi 1 pass) Billboard: 52.3m ² /hr (720 dpi x 720 dpi 2 pass) Banner: 29.4m ² /hr (720 dpi x 720 dpi 4 pass) Vinyl: 17.6m ² /hr (720 dpi x 1440 dpi 6 pass) Film: 6.8m ² /hr (1440 dpi x 1440 dpi 16 pass)
Paper Size	Single Roll, 2" or 3" core, 250 mm max outer diameter & 45kg max weight Sizing: 300 to 1626 mm wide, 500 mm min length, 1 mm max thickness
Interface	Hi-Speed USB 2.0, 100BASE-TX / 1000BASE-T
RIP Compatibility	Supplied with Epson Edge Print and supports a wide range of 3rd party applications
Memory	512 MB Main + 128 MB Network
Power Consumption	745W Operating / 445W Ready/ 13W Sleep
Dimensions (W x D x H)	2,620 x 1,338 x 972 mm (W x H x D)
Weight	291kg

COMMERCIAL & INDUSTRIAL PRINTER

SURECOLOR SC-S60670L

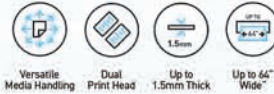

Max Print Width	64 inch
Print Head	Dual PrecisionCore™ TFP® Printhead
Max Resolution	1440 dpi x 1440 dpi
Min Droplet Size	4.2 pl
Ink System	Epson Ultrachrome® GS3
Type	Eco-Solvent Based
Colours	Dual C, M, Y, K (Choice of Standard)
Cartridge Size	2 x 4 x 1500 ml
Print Speed	Max Speed: 95.3m ² /hr (360 dpi x 720 dpi 1 pass) Billboard: 52.3m ² /hr (720 dpi x 720 dpi 2 pass) Banner: 29.4m ² /hr (720 dpi x 720 dpi 4 pass) Vinyl: 17.6m ² /hr (720 dpi x 1440 dpi 6 pass) Film: 6.8m ² /hr (1440 dpi x 1440 dpi 16 pass) Single Roll, 2" or 3" core, 250mm max outer diameter & 45kg max weight Sizing; 300 to 1626mm wide, 500mm min length, 1mm max thickness
Interface	High Speed USB & Ethernet 100Base-T / 1000Base-T
RIP Compatibility	Supplied with Epson Edge Print and supports a wide range of 3rd party applications
Memory	512 MB Main + 128 MB Network
Power Consumption	820W
Dimensions (W x D x H)	2,766 x 1,671 x 1,147mm
Weight	331kg w/ink

SURECOLOR SC-S80670



Max Print Width	64 inches
Print Head	DUAL Print Head PrecisionCore™ TFP® Printhead
Max Resolution	1440 dpi x 1440 dpi
Min Droplet Size	4.2 pl
Ink System	Epson Ultrachrome® GS3 & GS3+RED
Type	Eco-Solvent Based
Colours	C, M, Y, K, Lc, Lm, Lk, Or, Rd + (optional) White or Metallic Silver
Cartridge Size	9 x 700 ml + optional 1 x (600 ml Wht or 350 ml Mtl)
Print Speed	Max Speed(9c): 95.1m ² /hr (360 dpi x 360 dpi 1 pass) Billboard (9c): 31.6m ² /hr (720 dpi x 720 dpi 4 pass HS) Banner (9c): 18.2m ² /hr (720 dpi x 720 dpi 6 pass)
Paper Size	Input Format Single Roll with 2" or 3" core, 250 mm max outer diameter & 45kg max weight Sizing 300 to 1626 mm wide, 500 mm min length, 1 mm max thickness
Interface	High Speed USB 2.0 & Ethernet 100Base-T / 1000Base-T
RIP Compatibility	Supplied with Epson Edge Print and supports a wide range of 3rd party applications
Memory	2 GB, Network: 512MB +128MB
Power Consumption	745W Operating/380W Ready/14W Sleep
Dimensions (W x D x H)	2,620 x 1,338 x 880 mm (W x H x D)
Weight	284kg

COMMERCIAL & INDUSTRIAL PRINTER

S Surecolor Signage Series

SURECOLOR SC-S80670L



Max Print Width	64 inches
Print Head	Dual PrecisionCore™ TFP® Printhead
Max Resolution	1440 dpi x 1440 dpi
Min Droplet Size	4.2 pl
Ink System	Epson Ultrachrome® GS3 & GS3+RED
Type	Eco-Solvent Based
Colours	C, M, Y, K, Lc, Lm, Lk, Or, Rd + (optional) White or Metallic Silver
Cartridge Size	9 x 1500 ml + optional 1 x (all color 1500ml) 1500ml White and 500ml Silver Metallic
Print Speed	High Speed: 52.3m/hr (360 dpi x 720 dpi 2 pass)
Paper Handling	Rear Roll Feed / Auto take-up reel
Paper Size	Input Format Single Roll with 2" or 3" core, 250 mm max outer diameter & 45kg max weight Sizing 300 to 1626 mm wide, 500 mm min length, 1 mm max thickness
Interface	High Speed USB & Ethernet 100Base-TX / 1000Base-T
RIP Compatibility	Supplied with Epson Edge Print and supports a wide range of 3rd party applications
Memory	2GB, Network: 128 MB
Power Consumption	640W
Dimensions (W x D x H)	2,766 x 1,671 x 1,090 mm
Weight	326kg w/ink

D Surelab Photolab Series

SURELAB SL-D1030



Print Head	Micro Piezo Printhead
Max Resolution	1,440 x 720 dpi
Min Droplet Size	2.5 pl
Ink System	Epson UltraChrome D6r-S Dye Ink
Ink Capacity	250ml
Colours	Cyan, Magenta, Yellow, Light Cyan, Light Magenta, Black
Paper Size	Width: 89mm – 210mm ; Length: 148mm – 297mm
Print Size	Roll: Max. 1,000mm, Min. 50mm / Manual Feed: 1,000mm / Auto Sheet Feeder [ASF]: 297mm
Interface	Hi-Speed USB, 100BASE-TX/10BASE-T, IEEE802.11b/g/n, Wi-Fi
OS Compatibility	Windows® 10, Windows® 8.1 for each 32bit/64bit, Macintosh Mac OS X (10.9.5 or later), Mac OS 11.X
Power Consumption	Operating: Approx. 80W / Ready : Approx. 14W / Sleep: Approx. 1.2W / Standby: Approx. 0.2W
Dimensions (W x D x H)	Single-sided Model: 460 x 683 x 359 mm Double-sided Model: 460 x 747 x 441 mm
Weight	Single-sided model: 17.6kg Double-sided model: 23.1kg Main unit: 17.6kg, Duplex Feeder: 5.5kg

COMMERCIAL & INDUSTRIAL PRINTER

SURELAB SL-D3000



Print Method	Epson Micro Piezo™ on-demand inkjet with Variable Sized Droplet Technology
Max Resolution	1440 x 1440dpi (Gloss & Lustre) / 720 x 720 dpi (Matte)
Min Droplet Size	1.5pl
Ink System	Epson UltraChrome D6 Ink
Colours	Colours 6 (Cyan, Yellow, Magenta, Black, Light Cyan, Light Magenta) 700 ml per colour
Media Handling	Single Roll Model Dual Roll Model Rear roll up to 305mm / 12" media width Rear roll up to 305mm / 12" media width Front roll up to 210mm / 8" media width Auto-Switch between front / rear rolls
Printer Interface	USB 2.0 Hi-Speed
OS Compatibility	Microsoft Windows XP Professional (SP3), Windows 7 Professional (32- or 64-bit) 2.8 GHz Intel® Core 2 Duo or better
Memory	-
Power Consumption	500W Operating/ 60W Standby

SURELAB SL-D530



Print Method	Micro Piezo Inkjet Technology with Variable Sized Droplet Technology
Max Resolution	1440 x 720dpi (High Quality) / 720 x 720 dpi (Standard) / 720x360 (Draft)
Max Droplet Size	2.5pl
Ink System	Epson UltraChrome D6r-S Dye Ink
Colours	Colours 6 (Cyan, Magenta, Yellow, Light Cyan, Light Magenta, Black) 70 ml per colour
Media Handling	Auto Sheet Feeder Width: 89mm – 102mm ; Length: 127mm – 152mm Auto Sheet Feeder: 3.5" x 5", 4" x 6" (100 sheets)
Printer Interface	Hi-Speed USB, 100BASE-TX/10BASE-T, IEEE802.11b/g/n
OS Compatibility	Windows®11, Windows®10, Windows®8.1 for each 32bit/64bit, Macintosh Mac OS X (10/9/5 or later), Mac OS 11.X
Memory	0.5 GB
Power Consumption	18W Operating/ 3.8W Ready/1.4W Sleep/ 0.2W Standby

COMMERCIAL & INDUSTRIAL PRINTER

Commercial & Industrial Printer Consumable

Order Code	Description	Product	Order Code	Description	Product
C13T738100	Black	SC-B6070	C13T824800	Epson UltraChrome HD 350ml Matte Black Pigment Ink Cartridge	SC-P6000
C13T738200	Cyan		C13T824900	Epson UltraChrome HD 350ml Light Light Black Pigment Ink Cartridge	
C13T738300	Magenta		C13T824100	Epson UltraChrome HD 350ml Photo Black Pigment Ink Cartridge	SC-P8000
C13T738400	Yellow		C13T824200	Epson UltraChrome HD 350ml Cyan Pigment Ink Cartridge	
C13T904100	Black	SC-B9070	C13T824300	Epson UltraChrome HD 350ml Vivid Magenta Pigment Ink Cartridge	
C13T904200	Cyan		C13T824400	Epson UltraChrome HD 350ml Yellow Pigment Ink Cartridge	
C13T904300	Magenta		C13T824500	Epson UltraChrome HD 350ml Light Cyan Pigment Ink Cartridge	
C13T904400	Yellow		C13T824600	Epson UltraChrome HD 350ml Vivid Light Magenta Pigment Ink Cartridge	
C13T725100	Epson UltraChrome DG Ink - Black 600ml	SC-F2130	C13T824700	Epson UltraChrome HD 350ml Light Black Pigment Ink Cartridge	
C13T725200	Epson UltraChrome DG Ink - Cyan 600ml		C13T824800	Epson UltraChrome HD 350ml Matte Black Pigment Ink Cartridge	
C13T725300	Epson UltraChrome DG Ink - Magenta 600ml		C13T824900	Epson UltraChrome HD 350ml Light Light Black Pigment Ink Cartridge	
C13T725400	Epson UltraChrome DG Ink - Yellow 600ml		C13T824100	Epson UltraChrome HD 350ml Photo Black Pigment Ink Cartridge	SC-P7000
C13T725A00	Epson UltraChrome DG Ink - White 600ml		C13T824200	Epson UltraChrome HD 350ml Cyan Pigment Ink Cartridge	
C13S400080	D5 Transfer General Purpose 24 inch Roll	SC-F530	C13T824300	Epson UltraChrome HD 350ml Vivid Magenta Pigment Ink Cartridge	
C13S400079	D5 Transfer General Purpose 17 inch Roll		C13T824400	Epson UltraChrome HD 350ml Yellow Pigment Ink Cartridge	
C13S400081	D5 Transfer General Purpose A3 Roll		C13T824500	Epson UltraChrome HD 350ml Light Cyan Pigment Ink Cartridge	
C13S400082	D5 Transfer General Purpose A4 Roll		C13T824600	Epson UltraChrome HD 350ml Vivid Light Magenta Pigment Ink Cartridge	
C13S400077	D5 Transfer General Purpose A3 Sheet		C13T824700	Epson UltraChrome HD 350ml Light Black Pigment Ink Cartridge	
C13S400078	D5 Transfer General Purpose A4 Sheet		C13T824800	Epson UltraChrome HD 350ml Matte Black Pigment Ink Cartridge	
C12C933151	Stand (24")		C13T824900	Epson UltraChrome HD 350ml Light Light Black Pigment Ink Cartridge	
C12C935701	Roll Feed Spindle (24")		C13T824100	Epson UltraChrome HD 350ml Photo Black Pigment Ink Cartridge	SC-P7000
C13S210057	Maintenance Box		C13T824200	Epson UltraChrome HD 350ml Cyan Pigment Ink Cartridge	
C13S210055	Auto Cutter Spare Blade		C13T824300	Epson UltraChrome HD 350ml Vivid Magenta Pigment Ink Cartridge	
C13T46H200	Epson UltraChrome DS Ink - Cyan 1.1L	SC-F6630	C13T824400	Epson UltraChrome HD 350ml Yellow Pigment Ink Cartridge	
C13T46H300	Epson UltraChrome DS Ink - Magenta 1.1L		C13T824500	Epson UltraChrome HD 350ml Light Cyan Pigment Ink Cartridge	
C13T46H400	Epson UltraChrome DS Ink - Yellow 1.1L		C13T824600	Epson UltraChrome HD 350ml Vivid Light Magenta Pigment Ink Cartridge	
C13T46H800	Epson UltraChrome DS Ink - HD Black 1.1L		C13T824700	Epson UltraChrome HD 350ml Light Black Pigment Ink Cartridge	
C13T741200	Epson UltraChrome DS Ink - Cyan 1L x 6pcs	SC-F7270	C13T824800	Epson UltraChrome HD 350ml Matte Black Pigment Ink Cartridge	
C13T741300	Epson UltraChrome DS Ink - Magenta 1L x 6pcs		C13T824900	Epson UltraChrome HD 350ml Light Light Black Pigment Ink Cartridge	
C13T741400	Epson UltraChrome DS Ink - Yellow 1L x 6pcs		C13T824A00	Epson UltraChrome HDX 350ml Orange Pigment Ink Cartridge	
C13T741X00	Epson UltraChrome DS Ink - HD Black 1L x 6pcs		C13T824B00	Epson UltraChrome HDX 350ml Green Pigment Ink Cartridge	
C13T46H200	Epson UltraChrome DS Ink - Cyan 1.1L	SC-F9340	C13T824D00	Epson UltraChrome HDX 350ml Violet Pigment Ink Cartridge	
C13T46H300	Epson UltraChrome DS Ink - Magenta 1.1L		C13T809000	Epson UltraChrome Pro 700ml Light Grey Pigment Ink Cartridge	SC-P20070
C13T46H400	Epson UltraChrome DS Ink - Yellow 1.1L		C13T809100	Epson UltraChrome Pro 700ml Photo Black Pigment Ink Cartridge	
C13T46H800	Epson UltraChrome DS Ink - HD Black 1.1L		C13T809200	Epson UltraChrome Pro 700ml Cyan Pigment Ink Cartridge	
C13T46H600	Epson UltraChrome DS Ink - FY 1.1L		C13T809300	Epson UltraChrome Pro 700ml Vivid Magenta Pigment Ink Cartridge	
C13T46H500	Epson UltraChrome DS Ink - FP 1.1L		C13T809400	Epson UltraChrome Pro 700ml Yellow Pigment Ink Cartridge	
C13T327100	Photo Black	SC-P407	C13T809500	Epson UltraChrome Pro 700ml Light Cyan Pigment Ink Cartridge	
C13T327200	Cyan		C13T809600	Epson UltraChrome Pro 700ml Vivid Light Magenta Pigment Ink Cartridge	
C13T327300	Magenta		C13T809700	Epson UltraChrome Pro 700ml Dark Grey Pigment Ink Cartridge	
C13T327400	Yellow		C13T809800	Epson UltraChrome Pro 700ml Matte Black Pigment Ink Cartridge	
C13T327700	Red		C13T809900	Epson UltraChrome Pro 700ml Grey Pigment Ink Cartridge	
C13T327800	Matte Black		C13T913100	Epson UltraChrome HD 200ml Photo Black Pigment Ink Cartridge	SC-P5000
C13T327900	Orange		C13T913200	Epson UltraChrome HD 200ml Cyan Pigment Ink Cartridge	
C13T327000	Gloss Optimizer		C13T913300	Epson UltraChrome HD 200ml Vivid Magenta Pigment Ink Cartridge	
C13T763100	Photo Black	SC-P607	C13T913400	Epson UltraChrome HD 200ml Yellow Pigment Ink Cartridge	
C13T763200	Cyan		C13T913500	Epson UltraChrome HD 200ml Light Cyan Pigment Ink Cartridge	
C13T763300	Vivid Magenta				
C13T763400	Yellow				
C13T763500	Light Cyan				
C13T763600	Vivid Light Magenta				
C13T763700	Light Black				
C13T763800	Matte Black				
C13T763900	Light Light Black				
C13T853100	Photo Black	SC-P807			
C13T853200	Cyan				
C13T853300	Vivid Magenta				
C13T853400	Yellow				
C13T853500	Light Cyan				
C13T853600	Vivid Light Magenta				
C13T853700	Light Black				
C13T853800	Matte Black				
C13T853900	Light Light Black				
C13T824100	Epson UltraChrome HD 350ml Photo Black Pigment Ink Cartridge	SC-P6000			
C13T824200	Epson UltraChrome HD 350ml Cyan Pigment Ink Cartridge				
C13T824300	Epson UltraChrome HD 350ml Vivid Magenta Pigment Ink Cartridge				
C13T824400	Epson UltraChrome HD 350ml Yellow Pigment Ink Cartridge				
C13T824500	Epson UltraChrome HD 350ml Light Cyan Pigment Ink Cartridge				
C13T824600	Epson UltraChrome HD 350ml Vivid Light Magenta Pigment Ink Cartridge				
C13T824700	Epson UltraChrome HD 350ml Light Black Pigment Ink Cartridge				

COMMERCIAL & INDUSTRIAL PRINTER

Commercial & Industrial Printer Consumable

Order Code	Description	Product	Order Code	Description	Product
C13T913600	Epson UltraChrome HD 200ml Vivid Light Magenta Pigment Ink Cartridge	SC-P5000	C11CH13402	SC-P9530	SC-P9530
C13T913700	Epson UltraChrome HD 200ml Light Black Pigment Ink Cartridge		C13T44N100	SC-P9530 PK IC (700ml)	
C13T913800	Epson UltraChrome HD 200ml Matte Black Pigment Ink Cartridge		C13T44N200	SC-P9530 CY IC (700ml)	
C13T913900	Epson UltraChrome HD 200ml Light Light Black Pigment Ink Cartridge		C13T44N300	SC-P9530 VM IC (700ml)	
C13T913A00	Epson UltraChrome HDX 200ml Orange Pigment Ink Cartridge		C13T44N400	SC-P9530 YL IC (700ml)	
C13T913B00	Epson UltraChrome HDX 200ml Green Pigment Ink Cartridge		C13T44V500	SC-P9530 LC IC (350ml)	
C13T913D00	Epson UltraChrome HDX 200ml Violet Pigment Ink Cartridge		C13T44V600	SC-P9530 VL IC (350ml)	
C11CH12402	SC-P7530	SC-P7530	C13T44V700	SC-P9530 LB IC (350ml)	
C13T44N100	SC-P7530 PK IC (700ml)		C13T44V800	SC-P9530 MK IC (350ml)	
C13T44N200	SC-P7530 CY IC (700ml)		C13T44V900	SC-P9530 LI IC (350ml)	
C13T44N300	SC-P7530 VM IC (700ml)		C13T44VA00	SC-P9530 OR IC (350ml)	
C13T44N400	SC-P7530 YL IC (700ml)		C13T44VB00	SC-P9530 GR IC (350ml)	
C13T44N500	SC-P7530 LC IC (700ml)		C13T44VD00	SC-P9530 VI IC (350ml)	
C13T44N600	SC-P7530 VL IC (700ml)		C13T44V100	SC-P9530 P BLACK IC (350ml)	
C13T44N700	SC-P7530 LB IC (700ml)		C13T44V200	SC-P9530 P BLACK IC (350ml)	
C13T44N800	SC-P7530 MK IC (700ml)		C13T44V300	SC-P9530 VM IC (350ml)	
C13T44N900	SC-P7530 LI IC (700ml)		C13T44V400	SC-P9530 YL IC (350ml)	
C13T44NA00	SC-P7530 OR IC (700ml)		C13T44V500	SC-P7530 LC IC (350ml)	
C13T44NB00	SC-P7530 GR IC (700ml)		C13T44V600	SC-P7530 VL IC (350ml)	
C13T44ND00	SC-P7530 VI IC (700ml)		C13T44V700	SC-P7530 LB IC (350ml)	
C13T44V100	SC-P7530 PK IC (350ml)		C13T44V800	SC-P7530 MK IC (350ml)	
C13T44V200	SC-P7530 CY IC (350ml)		C13T44V900	SC-P7530 LI IC (350ml)	
C13T44V300	SC-P7530 VM IC (350ml)		C13T44VA00	SC-P7530 OR IC (350ml)	
C13T44V400	SC-P7530 YL IC (350ml)		C13T44VB00	SC-P7530 GR IC (350ml)	
C13T44V500	SC-P7530 LC IC (350ml)		C13T44VD00	SC-P7530 VI IC (350ml)	
C13T44V600	SC-P7530 VL IC (350ml)		C13T44V100	SC-P7530 P BLACK IC (350ml)	
C13T44V700	SC-P7530 LB IC (350ml)		C13T44V200	SC-P7530 CYAN IC (350ml)	
C13T44V800	SC-P7530 MK IC (350ml)		C13T44V300	SC-P7530 VM IC (350ML)	
C13T44V900	SC-P7530 LI IC (350ml)		C13T44V400	SC-P7530 YELLOW IC (350ml)	
C13T44VA00	SC-P7530 OR IC (350ml)		C13T44V500	SC-P7530 LT CYAN IC (350ml)	
C13T44VB00	SC-P7530 GR IC (350ml)		C13T44V600	SC-P7530 VLM IC (350ml)	
C13T44VD00	SC-P7530 VI IC (350ml)		C13T44V700	SC-P7530 GREY IC (350ml)	
C13T44V100	SC-P7530 P BLACK IC (350ml)		C13T44V800	SC-P7530 M BLACK IC (350ml)	
C13T44V200	SC-P7530 CYAN IC (350ml)		C13T44V900	SC-P7530 LT GREY IC (350ml)	
C13T44V300	SC-P7530 VM IC (350ML)		C13T44VA00	SC-P7530 ORANGE IC (350ml)	
C13T44V400	SC-P7530 YELLOW IC (350ml)		C13T44VB00	SC-P7530 GREEN IC (350ml)	
C13T44V500	SC-P7530 LT CYAN IC (350ml)		C13T44VD00	SC-P7530 VIOLET IC (350ml)	
C13T44V600	SC-P7530 VLM IC (350ml)		C13T49V110	SC-V7000 Black IC (1000ml)	SC-V7000
C13T44V700	SC-P7530 GREY IC (350ml)		C13T49V210	SC-V7000 Cyan IC (1000ml)	
C13T44V800	SC-P7530 M BLACK IC (350ml)		C13T49V310	SC-V7000 Magenta IC (1000ml)	
C13T44V900	SC-P7530 LT GREY IC (350ml)		C13T49V410	SC-V7000 Yellow IC (1000ml)	
C13T44VA00	SC-P7530 ORANGE IC (350ml)		C13T49V510	SC-V7000 Light Cyan IC (1000ml)	
C13T44VB00	SC-P7530 GREEN IC (350ml)		C13T49V610	SC-V7000 Light Magenta IC (1000ml)	
C13T44VD00	SC-P7530 VIOLET IC (350ml)		C13T49V710	SC-V7000 Gray IC (1000ml)	
C13T49V110	SC-V7000 Black IC (1000ml)		C13T49V810	SC-V7000 Red IC (1000ml)	
C13T49V210	SC-V7000 Cyan IC (1000ml)		C13T49V910	SC-V7000 White IC (1000ml)	
C13T49V310	SC-V7000 Magenta IC (1000ml)		C13T49VA10	SC-V7000 Varnish IC (1000ml)	
C13T49V410	SC-V7000 Yellow IC (1000ml)		C13T48R100	SC-P8530D PHOTO Black 700ML	SC-P8530D
C13T49V510	SC-V7000 Light Cyan IC (1000ml)		C13T48R200	SC-P8530D CYAN IC 700ML	
C13T49V610	SC-V7000 Light Magenta IC (1000ml)		C13T48R300	SC-P8530D MAGENTA IC 700ML	
C13T49V710	SC-V7000 Gray IC (1000ml)		C13T48R400	SC-P8530D YELLOW IC 700ML	
C13T49V810	SC-V7000 Red IC (1000ml)		C13T48R800	SC-P8530D MATTE BLACK IC 700ML	
C13T49V910	SC-V7000 White IC (1000ml)		C13T48RE00	SC-P8530D GRAY IC 700ML	
C13T49VA10	SC-V7000 Varnish IC (1000ml)		C11CH13402	SC-P9530	SC-P9530
C13T48R100	SC-P8530D PHOTO Black 700ML		C13T44N100	SC-P9530 PK IC (700ml)	
C13T48R200	SC-P8530D CYAN IC 700ML		C13T44N200	SC-P9530 CY IC (700ml)	
C13T48R300	SC-P8530D MAGENTA IC 700ML		C13T44N300	SC-P9530 VM IC (700ml)	
C13T48R400	SC-P8530D YELLOW IC 700ML		C13T44N400	SC-P9530 YL IC (700ml)	
C13T48R800	SC-P8530D MATTE BLACK IC 700ML		C13T44V500	SC-P9530 LC IC (350ml)	
C13T48RE00	SC-P8530D GRAY IC 700ML		C13T44V600	SC-P9530 VL IC (350ml)	
			C13T44V700	SC-P9530 LB IC (350ml)	
			C13T44V800	SC-P9530 MK IC (350ml)	
			C13T44V900	SC-P9530 LI IC (350ml)	
			C13T44VA00	SC-P9530 OR IC (350ml)	
			C13T44VB00	SC-P9530 GR IC (350ml)	
			C13T44VD00	SC-P9530 VI IC (350ml)	
			C13T44V100	SC-P9530 P BLACK IC (350ml)	
			C13T44V200	SC-P9530 P BLACK IC (350ml)	
			C13T44V300	SC-P9530 VM IC (350ml)	
			C13T44V400	SC-P9530 YL IC (350ml)	
			C13T44V500	SC-P9530 M BLACK IC (350ml)	
			C13T44V600	SC-P9530 LT GREY IC (350ml)	
			C13T44V700	SC-P9530 LT GREY IC (350ml)	
			C13T44V800	SC-P9530 ORANGE IC (350ml)	
			C13T44V900	SC-P9530 ORANGE IC (350ml)	
			C13T44VA00	SC-P9530 RED IC (700ML)	
			C13T44VB00	SC-P9530 GREEN IC (350ml)	
			C13T44VD00	SC-P9530 WHITE IC (600ML)	
			C13T45R100	SC-R5030 Black 3000ml (1.5L X2)	SC-R5030
			C13T45R200	SC-R5030 Cyan 3000ml (1.5L X2)	
			C13T45R300	SC-R5030 Magenta 3000ml (1.5L X2)	
			C13T45R400	SC-R5030 Yellow 3000ml (1.5L X2)	
			C13T45R500	SC-R5030 Light Cyan 3000ml (1.5L X2)	
			C13T45R600	SC-R5030 Light Magenta 3000ml (1.5L X2)	
			C13T45R700	SC-R5030 Optimizer 3000ml (1.5L X2)	
			C13T45R800	SC-R5030 Maintenance Liquid 3L (1.5L X2)	
			C13T43Y100	Epson UltraChrome D6r-S 200ml Black Ink Cartridge	SL-D830
			C13T43Y200	Epson UltraChrome D6r-S 200ml Cyan Ink Cartridge	
			C13T43Y300	Epson UltraChrome D6r-S 200ml Magenta Ink Cartridge	
			C13T43Y400	Epson UltraChrome D6r-S 200ml Yellow Ink Cartridge	
			C13T43Y500	Epson UltraChrome D6r-S 200ml Light Cyan Ink Cartridge	
			C13T43Y600	Epson UltraChrome D6r-S 200ml Light Magenta Ink Cartridge	
			C13T710100	Epson UltraChrome D6 700ml Black Dye Ink Cartridge	SL-D3000
			C13T710200	Epson UltraChrome D6 700ml Cyan Dye Ink Cartridge	
			C13T710300	Epson UltraChrome D6 700ml Magenta Dye Ink Cartridge	
			C13T710400	Epson UltraChrome D6 700ml Yellow Dye Ink Cartridge	
			C13T710500	Epson UltraChrome D6 700ml Light Cyan Dye Ink Cartridge	
			C13T710600	Epson UltraChrome D6 700ml Light Magenta Dye Ink Cartridge	

BUSINESS & PHOTO SCANNER



BUSINESS & PHOTO SCANNER

MENGAPA MEMILIH EPSON SCANNER ?

Dapatkan kecepatan dan kualitas terbaik dengan berbagai pilihan scanner terbaru dari Epson yang mampu menangkap semua detail untuk memenuhi kebutuhan bisnis Anda. Dengan fitur dan teknologi canggih milik Epson, Scanner ini memberi Anda lebih banyak daya, volume lebih tinggi, dan kecepatan lebih cepat untuk produktivitas lebih baik.

CCD System

Pemindai memanfaatkan Charge-Coupled Device (CCD) scanning system, memantulkan dokumen yang diterangi dari serangkaian cermin melalui lensa ke sensor

kelebihan dari Teknologi CCD

- Kecepatan pemindaian lebih tinggi
- lebih jelas dan lebih detail untuk pemindaian film
- Kedalaman bidang yang lebih besar saat memindai dokumen atau objek 3D yang tidak rata pada kaca pemindai
- Kepadatan optik lebih tinggi



CIS Scanner

Text on "contactless" area is not clear



CCD Scanner

Text on "contactless" area is clear

ReadyScan LED Technology

Dengan Teknologi ReadyScan LED, pemindaian dimulai secara instan tanpa memerlukan waktu pemanasan. Teknologi ini ramah lingkungan karena bebas merkuri, disipasi panas rendah dan membutuhkan konsumsi daya yang lebih rendah.



BUSINESS & PHOTO SCANNER

A4 Portable Sheet-Fed Scanner

WORKFORCE ES-50/ES-60W

Scan up to
A4 & F4Scan
600 dpiUSB 2.0
Bus-poweredWi-Fi
Only ES-60W

reddot award 2019
winner

Scanner Type	A4 Sheet-fed colour scanner
Sensor Type	Contact Image Sensor (CIS)
Light Source	RGB LED
Optical Resolution	600 x 600 dpi
Scan Area	A4 (support F4)
Document Size (Min)	50.8 x 50.8 mm
(Max)	216 x 1,828.8 mm
Supported Paper Weight	35 - 270 g/m2
ADF Capacity	1 sheet
Daily Scan Volume	Up to 300 sheets/day
Scanning Speed	5.5 sec (ES-50), 4.0 sec (Battery) / 5.5 sec
(200-300 dpi)	(USB Bus Powered) (ES-60W)
Operating System	Windows 7 / 8 / 8.1 / 10 Mac OS X 10.6.8 or later
Interface	USB 2.0 (Micro-B), Wi-Fi (ES-60W)
Dimensions	272 x 47 x 33.8 mm
Weight	270g (ES-50), 300g ES-60W

WORKFORCE DS-C330

Scan up to
A4 & F4Scan
600 dpiUSB 2.0
Bus-poweredU-Turn
ScanningEnvironmentally
Friendly

Scanner Type	A4 sheet-fed, one-pass duplex colour scanner
Sensor Type	Colour Contact Image Sensor (CIS) x 2
Light Source	RGB LEDx2
Optical Resolution	600 x 600 dpi
Scan Area	A4 (support F4)
Document Size (Min)	50.8 x 50.8 mm
(Max)	215.9 x 3.048 mm
Supported Paper Weight	Vertical Path 40-127 g/m2, Less than A6 size: 40-209 g/m2
Straight Path	40-413 g/m2
ADF Capacity	20 sheets (80 g/m2)
Daily Scan Volume	Up to 5,000 sheets/day
Scanning Speed	
Resolution (Colour/Monochrome)	Simplex / Duplex
	30 ppm / 60 ipm
	5 ppm / 10 ipm
Operating System	Windows 7/8/8.1/10/11, Server 2008/2012/2016/2019/2022
	MAC OS x 10.9 or later, MAC OS 11 or later
Interface	USB 2.0
Dimensions	296 x 104 x 125 mm
Weight	1,8 kg

BUSINESS & PHOTO SCANNER

WORKFORCE DS-360W

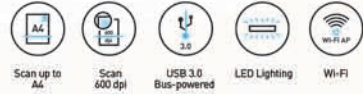

- Scanner Type** A4 sheet-fed, one-pass duplex scanner
- Sensor Type** Contact Image Scanner (CIS)
- Light Source** RGB LED
- Optical Resolution** 600 x 600 dpi
- Scan Area** A4 (support F4)
- Document Size (Min)** 50.8 x 70 mm
- (Max)** 216 x 1.117 mm
- Supported Paper Weight** 51.8-128 g/m2 (Postcard: 128-230 g/m2)
- ADF Capacity** 20 sheets (80 g/m2)
- Daily Scan Volume** Up to 500 pages/day
- Scanning Speed** 25 ppm/50 ipm (AC Adapter/Built-in Battery3), 5.0 ppm/10 ipm (USB 3.0 Bus Power)
- Operating System** Windows XP/ Vista / 7 / 8 / 8.1 / 10
Mac OS X 10.6.8 or later
- Interface** USB 3.0, Wi-Fi, Wi-Fi Direct
- Dimensions** 288 x 88.5 x 67 mm
- Weight** 1,3 kg

WORKFORCE ES-C320W



PDN



- Scanner Type** A4 sheet-fed, one-pass duplex colour scanner
- Sensor Type** Colour Contact Image Sensor (CIS) x 2
- Light Source** RGB LEDx2
- Optical Resolution** 600 x 600 dpi
- Scan Area** A4 (support F4)
- Document Size (Min)** 50.8 x 50.8 mm
- (Max)** 215,9 x 3.048 mm
- Supported Paper Weight** 40-127 g/m2, Less than A6 size: 40-209 g/m2
- Vertical Path** 40-413 g/m2
- Straight Path** 20 sheets (80 g/m2)
- ADF Capacity** Up to 3.500 sheets/day
- Daily Scan Volume**
- Scanning Speed**
- Resolution (Colour/Monochrome)** Simplex / Duplex
300 dpi / 60 ipm
600 dpi / 5 ppm / 10 ipm
- Operating System** Windows 7/8/8.1/10/11, Server
2008/2012/2016/2019/2022
MAC OS x 10.11 or later, MAC OS 11 or later
- Interface** USB 2.0, Wi-Fi (IEEE 802.11 b/g/n), Wi-Fi Direct
- Dimensions** 296 x 104 x 125 mm
- Weight** 1,8 kg

BUSINESS & PHOTO SCANNER

A4 Portable Sheet-Fed Scanner



PDN



WORKFORCE ES-C380W



Scan up to
A4 & F4



Scan
600 dpi



USB 2.0
Bus-powered



U-Turn
Scanning



Environmentally
Friendly

Scanner Type	A4 sheet-fed, one-pass duplex colour scanner
Sensor Type	Colour Contact Image Sensor (CIS) x 2
Light Source	RGB LEDx2
Optical Resolution	600 x 600 dpi
Scan Area	A4 (support F4)
Document Size (Min)	50.8 x 50.8 mm
(Max)	215.9 x 5.588 mm
Supported Paper Weight	40-127 g/m2, Less than A6 size: 40-209 g/m2
Vertical Path	40-413 g/m2
Straight Path	
ADF Capacity	20 sheets (80 g/m2)
Daily Scan Volume	Up to 3.500 sheets/day
Scanning Speed	
Resolution (Colour/Monochrome)	Simplex / Duplex
	30 ppm / 60 ipm
	5 ppm / 10 ipm
Operating System	Windows 7/8/8.1/10/11, Server 2008/2012/2016/2019/2022
	MAC OS x 10.11 or later, MAC OS 11 or later
Interface	USB 2.0, Wi-Fi (IEEE 802.11 b/g/n), Wi-Fi Direct, USB 2.0 Host
Dimensions	296 x 104 x 125 mm
Weight	1,8 kg

A4 Sheet-Fed Scanners

WORKFORCE DS-410



Scan up to
A3*



Scan
600 dpi



USB 2.0
Bus-powered



RGB LED
Lighting



Scanner Type	A4 Sheet-fed, one-pass duplex colour scanner
Sensor Type	Contact Image Sensor (CIS) x 2
Light Source	RGB LED
Optical Resolution	600 x 600 dpi
Scan Area	A4 (support F4)
Document Size (Min)	50.8 x 50.8 mm
(Max)	215.9 x 3,048 mm
Supported Paper Weight	50 - 209 g/m2 (A8 or less : 127 - 209 g/m2)
ADF Capacity	50 sheets (80g/m2)
Daily Scan Volume	Up to 3.000 sheets/day
Scanning Speed	26 ppm / 52 ipm (Monochrome, Colour)
Operating System	Windows XP / Vista / 7 / 8 / 8.1 / 10 / Server 2003 / 2008 / 2012 / 2016, Mac OS X 10.6.8 or later
Interface	USB2.0
Dimensions	297 x 152 x 154 mm
Weight	2,5kg

BUSINESS & PHOTO SCANNER



Total Nilai
TKDN + BMP

43.99%

WORKFORCE DS-530II



Scanner Type	A4 Sheet-fed, one-pass duplex colour scanner
Sensor Type	Contact Image Scanner (CIS)
Light Source	RGB LED
Optical Resolution	600 x 600 dpi
Document Size (Min)	50.8 x 50.8 mm
(Max)	215.9 x 6096 mm
Supported Paper Weight	27 - 413 g/m ² (A8 or less 127 - 413 g/m ²)
ADF Capacity	50 sheets (80g/m ²)
Daily Scan Volume	Up to 4.000 pages/day
Scanning Speed	
Resolution (Colour/Greyscale/Mono)	Simplex / Duplex 35 ppm / 70 ipm 12 ppm / 24 ipm
Operating System	Windows XP / Vista / 7 / 8 / 8.1 / 10 / Server 2003 / Server 2008 / Server 2012 / Server 2016 Mac OS X 10.6.8 or later
Interface	USB 3.2 Gen 1
Dimensions	296 x 169 x 176 mm
Weight	3.7 kg



Total Nilai
TKDN + BMP

43.27%

WORKFORCE DS-570WII



Scanner Type	A4 Sheet-fed, one-pass duplex colour scanner
Sensor Type	Contact Image Scanner (CIS)
Light Source	RGB LED
Optical Resolution	600 x 600 dpi
Document Size (Min)	50.8 x 50.8 mm
(Max)	215.9 x 6096 mm
Supported Paper Weight	27 - 413 g/m ² (A8 or less : 127 - 413 g/m ²)
ADF Capacity	50 sheets (80g/m ²)
Daily Scan Volume	Up to 4.000 pages/day
Scanning Speed	
Resolution (Colour/Greyscale/Mono)	Simplex / Duplex 35 ppm / 70 ipm 12 ppm / 24 ipm
Operating System	Windows XP / Vista / 7 / 8 / 8.1 / 10 / Server 2003 / Server 2008 / Server 2012 / Server 2016 Mac OS X 10.6.8 or later
Interface	USB 3.2 Gen 1, Wi-Fi (802.11 b/g/n)
Dimensions	296 x 169 x 176 mm
Weight	3.7 kg

BUSINESS & PHOTO SCANNER

A4 Sheet-Fed Scanners



Total Nilai
TKDN + BMP
43.06%

WORKFORCE ES-580W



Scan up to A4

Touchscreen Panel

One Pass Duplex Scanning

Wi-Fi

Epson Smart Panel

Scanner Type
Sensor Type
Light Source
Optical Resolution
Document Size (Min)
(Max)
Supported Paper Weight
ADF Capacity
Daily Scan Volume
Scanning Speed
Resolution (A4, Colour/Monochrome)

300 dpi

600 dpi

Operating System
Interface
Dimensions
Weight
A4 Sheet-fed, one pass duplex colour scanner
Colour Contact Image Sensor (CIS)

RGB LED

600 x 600 dpi

50.8 x 50.8 mm

215.9 x 6096 mm

27 - 413 g/m²100 sheets (80 g/m²)

Up to 4,000 sheets/day

35 ppm / 70 ipm

12 ppm / 24 ipm

Windows 7 / 8 / 8.1 / 10 / Server 2003 / Server

2008 / Server 2012 / Server 2016 / Server 2019

Mac OS X 10.6.8 or later

USB 3.2 Gen 1, Wi-Fi (802.11 b/g/n),

Wi-Fi Direct (max 8 connections)

296 x 169 x 167 mm

3.7kg



Total Nilai
TKDN + BMP
46.95%

WORKFORCE DS-730N



Scan up to A4

Colour LCD

One Pass Duplex Scanning

Ethernet

Scanner Type
Sensor Type
Light Source
Optical Resolution
Document Size (Min)
(Max)
Supported Paper Weight
ADF Capacity
Daily Scan Volume
Scanning Speed
Resolution (A4, Colour/Monochrome)

300 dpi

600 dpi

Operating System
Interface
Dimensions
Weight

Sheet-fed, one pass duplex colour scanner

Colour Contact Image Sensor (CIS)

RGB LED

600 x 600 dpi

50.8 x 50.8 mm

215.9 x 6096 mm

27 - 413 g/m²100 sheets (80 g/m²)

Up to 6,500 sheets/day

40 ppm / 80 ipm

12 ppm / 24 ipm

Windows XP SP3 / Vista / 7 / 8 / 8.1 / 10 / Server

2003 / Server 2008 / Server 2012 / Server 2016 /

Server 2019, Mac OS X 10.6.8 or later

USB2.0 and Ethernet

(1000BASE-T/100BASE-TX/10BASE-T)

296 x 169 x 167 mm

3.6kg

BUSINESS & PHOTO SCANNER



WORKFORCE DS-770II



Scanner Type	A4 Sheet-fed, one pass duplex colour scanner
Sensor Type	Contact Image Sensor (CIS)
Light Source	RGB LED
Optical Resolution	600 x 600 dpi
Document Size (Min)	50.8 x 50.8 mm
(Max)	215.9 x 6096 mm
Supported Paper Weight	27 - 413 g/m2 (A8 or less 127 - 413 g/m2)
ADF Capacity	100 sheets (80g/m ²)
Daily Scan Volume	Up to 7.000 sheets/day
Scanning Speed	
Resolution (Colour/Greyscale/Mono)	Simplex / Duplex
	45 ppm / 90 ipm
	12 ppm / 24 ipm
Operating System	Windows XP / Vista / 7 / 8 / 8.1 / 10 / Server 2003 / Server 2008 / Server 2012 / Server 2016
Interface	USB 3.2 Gen 1
Dimensions	296 x 169 x 176 mm
Weight	3.7 kg



WORKFORCE DS-790WN

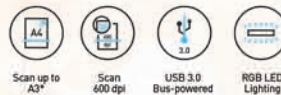

Scanner Type	A4 sheet-fed, one-pass duplex colour scanner
Sensor Type	Colour Contact Image Sensor (CIS) x 2
Light Source	RGB LED x 2
Optical Resolution	600 x 600 dpi
Document Size (Min)	50.8 x 50.8 mm
(Max)	215.9 x 6096 mm
Supported Paper Weight	27 - 413 g/m2 (A8 or less 127 - 413 g/m2)
ADF Capacity	100 sheets (80 g/m2)
Daily Scan Volume	Up to 7.000 sheets/day
Scanning Speed	
Resolution (Colour/Greyscale/Mono)	Simplex / Duplex
	45 ppm / 90 ipm
	12 ppm / 24 ipm
Operating System	Windows XP / Vista / 7 / 8 / 8.1 / 10 / 11, Server 2003 / 2008 / 2012 / 2019 / 2022 Mac OS X 10.6.8 or later
Interface	USB 3.2 Gen 1, Ethernet (1000BASE-T/100BASE-TX/10BASE-T), Wi-Fi (IEEE 802.11 b/g/n), Wi-Fi Direct (max 8 connections), USB 2.0 Host
Dimensions	296 x 169 x 167 mm
Weight	3,7kg

BUSINESS & PHOTO SCANNER

A4 Sheet-Fed Scanners



Total Nilai
TKDN + BMP
33.09%

WORKFORCE DS-870

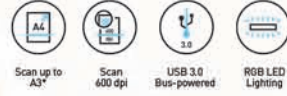

Scanner Type	A4 Sheet-fed, one pass duplex colour scanner
Sensor Type	Contact Image Sensor (CIS)
Light Source	RGB LED
Optical Resolution	600 x 600 dpi
Document Size (Min) (Max)	50.8 x 50.8 mm 215.9 x 6096 mm
Supported Paper Weight	27 - 413 g/m ² (A8 or less 127 - 413 g/m ²)
ADF Capacity	100 sheets (80 g/m ²)
Daily Scan Volume	Up to 10.000 sheets/day
Scanning Speed	
Resolution (Colour/Greyscale/Mono)	Simplex / Duplex 65 ppm / 130 ipm 16 ppm / 32 ipm
Operating System	Windows XP / Vista / 7 / 8 / 8.1 / 10 Mac OS X 10.6.8 or later
Interface	USB 3.0
Dimensions	296 x 169 x 167 mm
Weight	3,6kg

WORKFORCE DS-970



Total Nilai
TKDN + BMP
33.09%

Scanner Type	A4 Sheet-fed, one pass duplex colour scanner
Sensor Type	Contact Image Sensor (CIS)
Light Source	RGB LED
Optical Resolution	600 x 600 dpi
Scan Area	A4 (support F4)
Document Size (Min) (Max)	50.8 x 50.8 mm 215.9 x 6096 mm
Supported Paper Weight	27 - 413 g/m ² (A8 or less 127 - 413 g/m ²)
ADF Capacity	100 sheets (80 g/m ²)
Daily Scan Volume	Up to 14.000 sheets/day
Scanning Speed	
Resolution (Colour/Greyscale/Mono)	Simplex / Duplex 85 ppm / 170 ipm 23 ppm / 46 ipm
Operating System	Windows XP / Vista / 7 / 8 / 8.1 / 10 Mac OS X 10.6.8 or later
Interface	USB 3.0
Dimensions	296 x 169 x 167 mm
Weight	3,6kg

BUSINESS & PHOTO SCANNER

A3 Sheet-Fed Scanners

WORKFORCE DS-30000

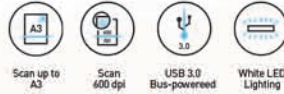

Total Nilai
TKDN + BMP
31.50%

Scanner Type	A3 sheet-fed, one-pass duplex colour scanner
Sensor Type	Colour Contact Image Sensor (CIS)
Light Source	White LED
Optical Resolution	600 x 600 dpi
Document Size (Min)	50.8 x 69 mm
(Max)	304.8 x 5.588 mm
Supported Paper Weight	27-413 g/m ²
ADF Capacity	A4 : 120 sheets, A3 : 60 sheets (80 g/m ²)
Daily Scan Volume	Up to 30.000 sheets/day
Scanning Speed	Simplex / Duplex 70 ppm / 140 ipm 22 ppm / 44 ipm
Resolution (A4, Colour/Monochrome)	200/300 dpi 600 dpi
Operating System	Windows XP SP3 / Vista / 7 / 8 / 8.1 / 10 Windows Server 2003 / 2008 / 2012 / 2016 / 2019, Mac OS X 10.6.8 or later
Interface	USB 3.0
Dimensions	371 x 208 x 219 mm
Weight	5.8 kg

WORKFORCE DS-32000

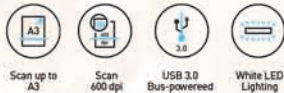

Total Nilai
TKDN + BMP
34.44%

Scanner Type	A3 sheet-fed, one-pass duplex colour scanner
Sensor Type	Colour Contact Image Sensor (CIS)
Light Source	White LED
Optical Resolution	600 x 600 dpi
Document Size (Min)	50.8 x 69 mm
(Max)	304.8 x 5.588 mm
Supported Paper Weight	20 - 413 (80 g/m ²)
ADF Capacity	A4 120 sheets, A3 : 60 sheets Delicate Feed Mode : 20 sheets (A4), 10 sheets (A3)
Daily Scan Volume	Up to 40.000 sheets/day
Scanning Speed	Simplex / Duplex 90 ppm / 180 ipm 26 ppm / 52 ipm
Resolution (A4, Colour/Monochrome)	200/300 dpi 600 dpi
Operating System	Windows XP SP3 / Vista / 7 / 8 / 8.1 / 10 Windows Server 2003 / 2008 / 2012 / 2016 / 2019, Mac OS X 10.6.8 or later
Interface	USB 3.0
Dimensions	371 x 167 x 245mm
Weight	6.9 kg

BUSINESS & PHOTO SCANNER

A4 Flatbed Business Scanner

WORKFORCE DS-1630



Scan up to A4



Scan 1200 dpi



RGB LED Lighting



USB 2.0 Bus-powered



Total Nilai
TKDN + BMP

45.79%



Scanner Type Flatbed colour image scanner with ADF
Sensor Type Colour Contact Image Sensor (CIS)
Light Source RGB LED
Optical Resolution 1200 dpi x 1200 dpi
Document Size (Min) 89 x 127 mm (ADF Simplex), 89 x 170 mm (ADF Duplex)

(Max) 216 x 297 mm (Flatbed), 215.9 x 3048 mm (ADF Simplex)

Supported Paper Weight 50 - 120 g/m²
ADF Capacity 50 sheets (80g/m²)
Daily Scan Volume Up to 1,500 sheets/day
Scanning Speed Colour

Flatbed approx. 7.0 sec, 1.4 msec/line
ADF approx. 26 sec, 3.2 msec/line

Operating System 25 ppm / 10 ipm
 9.0 ppm / 6.0 ipm
 Windows XP SP3 / Vista / 7 / 8 / 8.1 / 10
 Windows Server 2003 / 2008 / 2012 / 2016 / 2019, Mac OS X 10.6.8 or later

Interface USB 3.0
Dimensions 450x318x121mm
Weight 4.1kg

WORKFORCE DS-6500



Scan up to A4



Scan 1200 dpi



USB 3.0 Bus-powered



White LED Lighting



Scanner Type A4 Flatbed colour image scanner with duplex ADF

Sensor Type 4 Line Colour CCD
Light Source White LED

Optical Resolution 1200 dpi x 1200 dpi
Document Size (Min) 100 mm x 148 mm (ADF)
(Max) 215.9 mm x 1016 mm (ADF)

Supported Paper Weight 50 - 128 g/m² (<A6 60 - 190 g/m²)
ADF Capacity 100 sheets (80 g/m²)
Daily Scan Volume Up to 3,000 sheets/day
Scanning Speed Colour 24-bit

Flatbed approx. 8.0 sec, 0.6 msec/line
ADF approx. 22 sec, 1.69 msec/line

Operating System 25 ppm / 50 ipm
 4 ppm / 8 ipm
 Windows XP SP3 / Vista / 7 / 8 / 8.1 / 10
 Windows Server 2003 / 2008 / 2012 / 2016 / 2019, Mac OS X 10.6.8 or later

Interface Hi-Speed USB 2.0
Dimensions 217 x 495 x 360 mm
Weight 9.8 kg

BUSINESS & PHOTO SCANNER

A4 Flatbed Business Scanner

WORKFORCE DS-7500



Scan up to A4



Scan 1200 dpi



USB 2.0 Bus-powered



White LED Lighting



Scanner Type

A4 Flatbed colour image scanner with duplex ADF

Sensor Type

4 Line Colour CCD

Light Source

White LED

Optical Resolution

1200 dpi x 1200 dpi

Document Size (Min)

100 mm x 148 mm (ADF)

(Max)

215.9 mm x 1016 mm (ADF)

Supported Paper Weight

50 - 128 g/m² (<A6 60 - 190 g/m²)

ADF Capacity

100 sheets (80 g/m²)

Daily Scan Volume

Up to 4,000 sheets/day

Scanning Speed

Colour 24-bit

Flatbed

300 dpi

8.0 sec, 0.6 msec/line

600 dpi

22 sec, 1.69 msec/line

ADF

200-300 dpi

40 ppm / 80 ipm

600 dpi

8 ppm / 13 ipm

Operating System

Windows XP SP3 / Vista / 7 / 8 / 8.1 / 10

Windows Server 2003 / 2008 / 2012 / 2016 /

2019, Mac OS X 10.6.8 or later

Interface

Hi-Speed USB 2.0

Dimensions

217 x 495 x 360 mm

Weight

9.8 kg

A3 Flatbed Business Scanner

WORKFORCE DS-50000



Scan up to A3



Scan 600 dpi



USB 2.0 Bus-powered



Scanner Type

A3 Flatbed colour image scanner

Sensor Type

4 Line Colour CCD

Light Source

White LED

Optical Resolution

600 dpi x 600 dpi

Document Size (Max)

A3 (11.7" x 17")

Scanning Speed

Colour 24-bit

Flatbed

300 dpi

approx. 4.0 sec, 0.351 msec/line

600 dpi

approx. 10 sec, 0.702 msec/line

Operating System

Windows XP SP3 / Vista / 7 / 8 / 8.1 / 10

Windows Server 2003 / 2008 / 2012 / 2016 /

2019, Mac OS X 10.6.8 or later

Interface

Hi-Speed USB 2.0

Dimensions

640x468x156mm

Weight

14.8 kg

BUSINESS & PHOTO SCANNER

A3 Flatbed Business Scanner

WORKFORCE DS-60000



Scan up to A3



Scan 600 dpi



USB 2.0 Bus-powered



White LED Lighting



Scanner Type	A3 Flatbed colour image scanner with ADF
Sensor Type	4 Line Colour CCD
Light Source	White LED
Optical Resolution	600 dpi x 600 dpi
Document Size (Min)	68 mm x 120 mm
(Max)	297 mm x 2540 mm
Supported Paper Weight	35 - 128 g/m ² (<A6 60 - 190 g/m ²)
ADF Capacity	200 sheets (80 g/m ²)
Daily Scan Volume	Up to 5,000 sheets/day
Scanning Speed	Colour 24-bit
Flatbed	
300 dpi	approx. 4.0 sec, 0.351 msec/line
600 dpi	approx. 10 sec, 0.702 msec/line
ADF	
200-300 dpi	40 ppm / 80 ipm
600 dpi	7.5 ppm / 15 ipm
Operating System	Windows XP SP3 / Vista / 7 / 8 / 8.1 / 10 Windows Server 2003 / 2008 / 2012 / 2016 / 2019, Mac OS X 10.6.8 or later
Interface	Hi-Speed USB 2.0
Dimensions	640x552x289mm
Weight	26.9 kg

WORKFORCE DS-70000



Scan up to A3



Scan 600 dpi



USB 2.0 Bus-powered



White LED Lighting



Scanner Type	A3 Flatbed colour image scanner with ADF
Sensor Type	4 Line Colour CCD
Light Source	White LED
Optical Resolution	600 dpi x 600 dpi
Document Size (Min)	68 mm x 120 mm
(Max)	297 mm x 2540 mm
Supported Paper Weight	35 - 128 g/m ² (<A6 60 - 190 g/m ²)
ADF Capacity	200 sheets (80 g/m ²)
Daily Scan Volume	Up to 8,000 sheets/day
Scanning Speed	Colour 24-bit
Flatbed	
300 dpi	approx. 4.0 sec, 0.351 msec/line
600 dpi	approx. 10 sec, 0.702 msec/line
ADF	
200-300 dpi	70 ppm / 140 ipm
600 dpi	12 ppm / 24 ipm
Operating System	Windows XP SP3 / Vista / 7 / 8 / 8.1 / 10 Windows Server 2003 / 2008 / 2012 / 2016 / 2019, Mac OS X 10.6.8 or later
Interface	Hi-Speed USB 2.0
Dimensions	289 x 640 x 552 mm
Weight	26.9 kg

BUSINESS & PHOTO SCANNER

A4 Photo Scanners



PERFECTION V3911



Scanner Type	A4 Flatbed Colour Image Scanner	
Sensor Type	Contact Image Sensors (CIS)	
Light Source	RGB LED	
Optical Resolution	4,800 x 4,800 dpi	
Output Resolution	50 – 4,800 dpi (in 1 dpi increments), 7,200 dpi, 9,600 dpi	
Document Size	216 x 297 mm	
Scanning Speed	DPI	Speed
Reflective Scanning	300	10 sec
	600	12 sec
	1,200	37 sec
	300	10 sec
Monochrome	600	29 sec
	1,200	103 sec
	Operating System	
	Windows 7 / 8 / 8.1 / 10 / 11, Server 2003 / 2008 / 2012 / 2016 / 2019	
	Mac OS X 10.11 or later	
Interface	USB 2.0	
Dimensions	249 x 364 x 39 mm	
Weight	1.4 kg	

PERFECTION V850

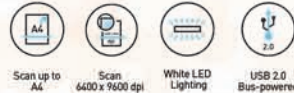

Scanner Type	Flatbed colour image scanner	
Sensor Type	Epson Matrix CCD	
Light Source	White LED	
Optical Resolution	Main 6,400 dpi x Sub 9,600 dpi (Film Scanning with Film Holder)	
Output Resolution	25 to 12,800 dpi (in 1 dpi increments)	
Document Size	Up to 216 x 297 mm	
Reflective	Up to 203 x 254 mm, 35mm x 18 frames strip film,	
	35mm x 12 frames mounted film, [6 x 20cm] x 1	
Transparency	frame Medium format, [4" x 5"] x 1 frame, Up to 8" x 10" (with film area guide)	
	DPI	Speed
Scanning Speed	300	6 sec
	300	12 sec
	300	12 sec
Reflective Scanning	Preview	
Monochrome	300 12 sec	
24 bit Colour	300 12 sec	
Operating System	Microsoft Windows XP / Vista / 7 / 8 / 8.1 / 10	
	Mac OS X 10.6.8 or later	
Interface	USB 2.0	
Dimensions	308 x 503 x 152.5 mm	
Weight	6.6 kg	

BUSINESS & PHOTO SCANNER

A3 Flatbed Business Scanner

EXPRESSION 13000XL

Scan up to
A3Scan
2400 x 4800 dpi

LED Lighting



Scanner Type	A3 Flatbed Colour Image Scanner
Sensor Type	6-line Colour CCD
Light Source	White LED
Optical Resolution	2400 x 4800 dpi
Output Resolution	50 - 6400 dpi (1 dpi increments)
Document Size (Max)	310 x 437 mm [12.2 x 17.2"] (Flatbed) 309 x 420 mm [12.2 x 16.5"] (TPU)
Film Capacity	35 mm film x 48 Frames (Strip Film Holder) 35 mm film x 30 Frames (Mounted Film Holder)
Scanning Speed	A4 300 dpi Colour/BW 12 sec
Operating System	Windows XP / Vista / 7 / 8 / 8.1 / 10 / Server 2003/2008/2012, Mac OS X 10.6.8 or later
Interface	USB 2.0
Dimensions	656 x 458 x 158 mm
Weight	14.3 kg

Manage your Documents/Photos Effortlessly

Epson ScanSmart*

Photo

Large originals can be scanned and stitched into a single image with Epson ScanSmart. This software can also perform automatic enhancements to photos and save your files into a variety of formats.

*Only applicable to V39 and V850

Document

Simplify your workflow with Epson ScanSmart. Review and edit your scans to rotate, delete, reorder or remove unnecessary pages. Save with automatic file and folder name by OCR detection for increased productivity.

**Only applicable to ES-50 and ES-60W



Epson DocumentScan App



Scan documents with your mobile devices and share it via email, through other apps or save it to selected cloud services such as Box, DropBox, Evernote®, Google® Drive™ and Microsoft® OneDrive®.

Easy Photo Scan

Through a simple user interface, users can easily scan, view, edit, save and transfer scanned documents via Easy Photo Scan. 8 simple photo editing functions such as Rotation, Auto and Manual Enhance, Soft Focus and Red Eye Correction are also available for users to enhance and correct their photos as desired. The preview mode and thumbnail mode allow users to easily choose, edit and preview photos within the application.

Post-scan destinations, including local folder, Web Folder, email, Facebook, Picasa™, Evernote® and SugarSync®, are easily accessible through the software.

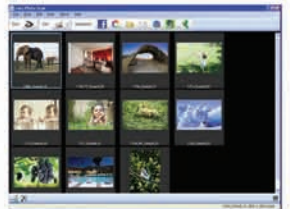

Document Capture Pro**



Easily scan, view, edit, save and transfer scanned documents. The software recognises barcodes, characters and blank pages in scanned documents for batch separation. It allows you to create up to 30

customised job settings, with the option to assign shortcuts of the scan jobs to the scanner's operation panel to simplify scan workflow. With the built-in OCR capability, searchable PDF files can be created and documents can be saved into editable Microsoft Office formats. In addition, device and documents can be secured through password protection, by locating and tracking documents using the Advanced Log function.

**Limited functionality for Mac version of Document Capture software.

Document Capture Pro Server***



Document Capture Pro Server helps to centralise your scanning and manage your fleet of scanners without the need to install drivers on individual computers.

Document Capture Pro Server - Authentication Edition secures your scanner by limiting usage based on user list. Link the scanner to your directory services for automatic syncing of the user list and the Email server to enable Scan to Email, alerts, and reporting functions.

***Only for Windows Server OS.

InstantMark OMR Software

An affordable Optical Mark Recognition (OMR) solution that provides fast and accurate detection of data from optical answer sheets used for tests, assessments, surveys and other questionnaires. It allows users to create or use existing form templates for their projects too.

Presto! Bizcard 5

A business card management solution that keeps a digital database of your business contacts. Information is extracted from the business cards by OCR.

BUSINESS & PHOTO SCANNER

Scanner Functions

Photo

Photo Enhancement

Inject new life into faded films and photos. Restore original colours of faded photos to make them look as good as new with colour restoration.



Before Colour Restoration



After Colour Restoration

Built-in Transparency Unit with Film Holder

Selected Epson photo scanners feature a built-in transparency unit with film holder which allows users to conveniently digitise precious and fragile photo films and slides.



Document

Text Enhancement

Improves text recognition when scanning text documents, whether in colour, greyscale or black-and-white. Removes background for better clarity, which is especially useful for double-sided printed documents.



Text Enhancement OFF



Text Enhancement ON

Document Skew Correction

Automatically adjusts and straightens scanned images.

Colour Enhancement & Colour Dropout

Remove or enhance the visibility of ink signatures such as "Confidential" and "Urgent" stamps. Users can pick one of the preset colours, all colours except black), or use the customised settings to dropout or enhance up to 5 colours of your choice with a single scan. Up to 10 preset colours can be saved for reuse.



Automatic Feeding Mode

The Automatic Feeding Mode enables large volumes of documents to be scanned continuously. In addition, this mode allows you to scan documents one at a time without needing to arrange them by size and they will be saved into a single PDF.



Double Feed Detection Skip Function

Activate the Double Feed Detection Skip function to scan documents with stickers and labels.



Book Spine Correction

Scans are corrected for shadow and curvature around book spines for better readability and clarity of texts and images.



Paper Protection Function

Upon detection of abnormal paper feeding or stapled/folded paper, the paper feed will be stopped immediately, which prevents damage to your important documents.



Epson OCR Feature

This OCR add-on allows users to create searchable PDF files and automatically straighten and orientate documents based on character recognition.

PDF Security

Advanced PDF Security features are bundled with document scanners to prevent confidential documents from being accessed, edited or printed by unauthorised users. Passwords can be used to secure the PDF files.

Auto Area Segmentation (AAS)

This feature is useful when user is performing a black-&-white scan on documents with pictures and graphs. AAS segments a scanned document which has both text and image into 'Text Area' and 'Image Area'. The 'Text Area' is scanned in black-&-white and 'Image Area' is scanned in halftone.

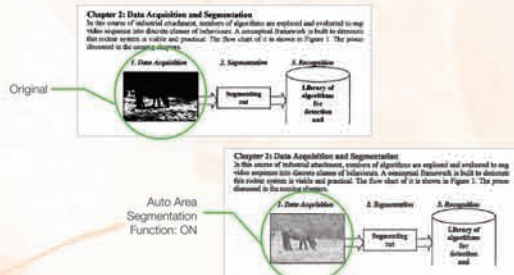

3LCD PROJECTOR



ECO



23 YEARS RUNNING SINCE 2001 - 2023
SOURCE: FUTURESOURCE CONSULTING

3LCD PROJECTOR

MENGAPA MEMILIH 3LCD PROJECTOR ?

Projektor Epson 3LCD menghadirkan warna-warna menakjubkan dengan tingkat kecerahan yang seimbang, realistis, dan hasil gambar yang lebih hidup. Tidak heran jika projektor Epson adalah pilihan utama masyarakat.



EPSON 3LCD TECHNOLOGY UNTUK WARNA CERAH & LEBIH NYATA

3LCD projectors offer brighter and more accurate as they produce different shades and hues by filtering, then mixing beams of the three primary colours (red, green and blue).

In a 3LCD projector, white light is first split into the three beams of primary colours. Each beam is then filtered through its own LCD that will give each individual pixel of the image its exact brightness for each colour. The colour beams are then perfectly recombined in a prism before being projected out as a complete image.

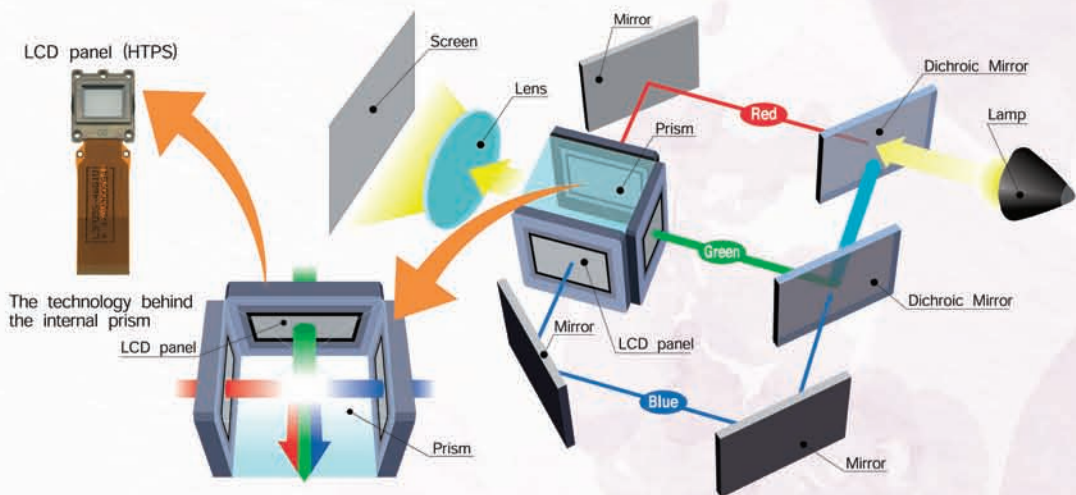

3LCD PROJECTOR

Small Sized Rooms

3LCD PROJECTOR

EB-E01



Brightness 3,300 lm	Resolution XGA	Contrast 15,000:1
Light Source Life 6,000/12,000 hrs	Keystone ±30° (V) / ±30° (H)	Connectivity USB Type-B x 1, VGA x 1, HDMI x 1
Network N/A	Power Consumption 327W / 225W	Weight 2.4 kg



12,000 Hours
Lamp Life in Eco Mode



Split Screen

EB-X06



Brightness 3,600 lm	Resolution XGA	Contrast 16,000:1
Light Source Life 6,000/12,000 hrs	Keystone ±30° (V) / ±30° (H)	Connectivity USB Type-B x 1, VGA x 1, HDMI x 1
Network Optional (ELPAP11)	Power Consumption 327W / 225W	Weight 2.5 kg



12,000 Hours
Lamp Life in Eco Mode



Split Screen



Auto Vertical
Keystone



Horizontal
Keystone Adjuster



Wireless
iProjection

3LCD PROJECTOR



Total Nilai
TKDN + BMP

53.00%

E600 untuk Indonesia

**NEW
PRODUCT**



EB-E600

Brightness 3,400 lm	Resolution XGA	Contrast 15,000:1
Light Source Life 6,000/12,000 hrs	Keystone ±30° (V) / ±30° (H)	Connectivity USB Type-B x 1, VGA x 2, RCA x 1, HDMI x 1
Network N/A	Power Consumption 327W / 225W	Weight 2.7 kg



12,000 Hours
Lamp Life in Eco Mode



Split Screen

PROYEKTOR KARYA ANAK BANGSA

TERBAIK KUALITASNYA
TERTINGGI TKDN-NYA.



EB-E600/X600

Proyektor Pendidikan
dan Perkantoran



3LCD PROJECTOR

Small Sized Rooms



Total Nilai
TKDN + BMP
52.30%

X600 untuk Indonesia



EB-X600

Brightness 3,600 lm	Resolution XGA	Contrast 16,000:1
Light Source Life 6,000/12,000 hrs	Keystone ±30° (V) / ±30° (H)	Connectivity USB Type-A & B x 1, VGA x 2, RCA x 1, HDMI x 1
Network RJ45 x 1, Optional (ELPAP11)	Power Consumption 327W / 225W	Weight 2.7 kg



12,000 Hours
Lamp Life in Eco Mode



Split Screen



Auto Vertical
Keystone



Horizontal Keystone
Adjuster*



Wireless
iProjection

EB-X51



Brightness 3,800 lm	Resolution XGA	Contrast 16,000:1
Light Source Life 6,000/12,000 hrs	Keystone ±30° (V) / ±30° (H)	Connectivity HDMI in x1, VGA in x1 RCA x1, 2RCA x1 USB Type-A & Bx1
Network Optional (ELPAP11)	Power Consumption 327W / 225W	Weight 2.5 kg



12,000 Hours
Lamp Life in Eco Mode



Split Screen



Auto Vertical
Keystone



Horizontal Keystone
Adjuster*



Wireless
iProjection

3LCD PROJECTOR

EB-W51



Brightness 4,000 lm	Resolution WXGA	Contrast 16,000:1
Light Source Life 6,000/12,000 hrs	Keystone ±30° (V) / ±30° (H)	Connectivity HDMI in x1, VGA in x1 RCA x1, 2RCA x1 USB Type-A & Bx1
Network Optional (ELPAP11)	Power Consumption 327W / 225W	Weight 2.5 kg



12,000 Hours
Lamp Life in Eco Mode



Split Screen



Auto Vertical
Keystone



Horizontal Keystone
Adjuster*



Wireless
iProjection

EB-FH52



Brightness 4,000 lm	Resolution 1080p	Contrast 16,000:1
Light Source Life 5,500/12,000 hrs	Keystone ±30° (V) / ±30° (H)	Connectivity HDMI in x2, VGA in x1 RCA x1, 2RCA x1 USB Type-A & Bx1
Network Built-in Support Screen Mirroring	Power Consumption 327W / 225W	Weight 3.1 kg



12,000 Hours
Lamp Life in Eco Mode



Split Screen



Auto Vertical
Keystone



Horizontal Keystone
Slider



Wireless iProjection
/ Screen Mirroring



Full HD
Resolution

3LCD PROJECTOR

Small Sized Rooms

EB-972



Brightness 4,100 lm	Resolution XGA	Contrast 16,000:1
Light Source Life 6,500/17,000 hrs	Keystone ±30° (V) / ±30° (H)	Connectivity HDMI in x2, VGA in x1, VGA out x1, RCA in x1, 2RCA x1 Stereo Mini Jack in x2 Stereo Mini Jack out x1 USB Type-A & Bx1
Network Optional (ELPAP11)	Power Consumption 327W / 225W	Weight 3.1 kg



17,000 Hours
Lamp Life in Eco Mode



Split Screen



Auto Vertical
Keystone



Horizontal Keystone
Slider



Wireless
iProjection

EB-982W



Brightness 4,200 lm	Resolution WXGA	Contrast 16,000:1
Light Source Life 6,500/17,000 hrs	Keystone ±30° (V) / ±30° (H)	Connectivity HDMI in x2, VGA in x1, VGA out x1, RCA in x1, 2RCA x1 Stereo Mini Jack in x2 Stereo Mini Jack out x1 USB Type-A & Bx1
Network Optional (ELPAP11)	Power Consumption 327W / 225W	Weight 3.1 kg



17,000 Hours
Lamp Life in Eco Mode



Split Screen



Auto Vertical
Keystone



Horizontal Keystone
Slider



Wireless
iProjection

3LCD PROJECTOR

Ultra Portable Projectors

3LCD PROJECTOR

EB-1785W Gesture Presenter



Brightness 3,200lm	Resolution WXGA	Contrast 10,000:1
Light Source Life 4,000 / 7,000 hrs	Keystone ±45°(V) / ±30°(H)	Connectivity VGA in x1, HDMI in x1 [Support MHL] Stereo Mini Jack in x1 USB Type-A & Bx1
Network Built-in Support Screen Mirroring	Power Consumption 295W / 208W	Weight 1.81 kg



Gesture
Presenter



NFC



Wireless
Projection



Real-Time Auto V/H
Keystone Correction



Split Screen



reddot design award

EB-1795F Gesture Presenter



Brightness 3,200lm	Resolution 1080p	Contrast 10,000:1
Light Source Life 4,000 / 7,000 hrs	Keystone ±45°(V) / ±30°(H)	Connectivity HDMI in x1 [Support MHL] VGA in x1, RCA x1 Stereo Mini Jack in x1 USB Type-A & Bx1
Network Built-in Support Screen Mirroring	Power Consumption 295W / 208W	Weight 1.83 kg



Gesture
Presenter



NFC



Wireless
Projection



Real-Time Auto V/H
Keystone Correction



Split Screen



Full HD

3LCD PROJECTOR

Mid Size Rooms Projectors

3LCD PROJECTOR

EB-2265U Gesture Presenter



Brightness 5,500lm	Resolution WUXGA	Contrast 15,000:1
Light Source Life 5,000 / 10,000 hrs	Keystone ±30°(V) / ±30°(H)	Connectivity HDBaset x1, HDMI in x2 (1 Support MHL) VGA in x2, VGA out x1 Stereo Mini Jack in x2 Stereo Mini Jack out x1 2RCA x1, RCA x1, RS-232C x1, RJ45 x1 USB Type-A & Bx1
Network Optional (ELPAP10)	Power Consumption 425W / 323W	Weight 4.7 kg



Gesture Presenter



Multi-PC Projection



Wireless Projection



Split Screen

EB-2155W



Brightness 5,000lm	Resolution WXGA	Contrast 15,000:1
Light Source Life 5,000 / 10,000 hrs	Keystone ±30°(V) / ±30°(H)	Connectivity HDMI in x2 (1 Support MHL) VGA in x2, VGA out x1 Stereo Mini Jack in x2 Stereo Mini Jack out x1 2RCA x1, RCA x1, RS-232C x1, RJ45 x1 USB Type-A & Bx1
Network Optional (ELPAP10)	Power Consumption 405W / 323W	Weight 4.3 kg



Gesture Presenter



Multi-PC Projection



Wireless Projection



Split Screen

3LCD PROJECTOR



EB-L630U/EB-L730U



Wireless Projection

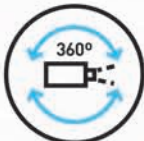

Flexible 360 degree installation



WUXGA Resolution



Edge Blending Technology

EB-L630U

Brightness 6,200 lm	Resolution WUXGA (16:10)	Contrast over 2,500,000 : 1
Light Source Life 20,000 hours	Keystone ±30°(V) / ±30°(H)	Connectivity D-Sub 15Pin IN x 2, HDMI In x 2, HDBaseT RJ45 In x 1, D-Sub 15Pin Out x 1, Stereo Mini Jack In x 2, Stereo Mini Jack Out x 1, USB Type A x 1, USB Type B x 1, RS-232C D-Sub 15Pin x 1, Wired Lan RJ45 x 1, HDMI Out x1
Network Built-In	Power Consumption 345W / 258W	Weight Approx 8.4 Kg

EB-L730U

Brightness 7,000 lm	Resolution WUXGA (16:10)	Contrast over 2,500,000 : 1
Light Source Life 20,000 hours	Keystone ±30°(V) / ±30°(H)	Connectivity D-Sub 15Pin IN x 2, HDMI In x 2, HDBaseT RJ45 In x 1, D-Sub 15Pin Out x 1, Stereo Mini Jack In x 2, Stereo Mini Jack Out x 1, USB Type A x 1, USB Type B x 1, RS-232C D-Sub 15Pin x 1, Wired Lan RJ45 x 1, HDMI Out x1
Network Built-In	Power Consumption 345W / 258W	Weight Approx 8.4 Kg

3LCD PROJECTOR

Mid Size Rooms Projectors



EB-L570U/EB-L770U



Wireless Projection



Flexible 360 degree installation



Edge Blending Technology

EB-L570U

Brightness 5,200 lm	Resolution WUXGA (4K Enhancement)	Contrast over 2,500,000 : 1
Light Source Life 20,000 hours	Keystone $\pm 30^\circ(V) / \pm 30^\circ(H)$	Connectivity HDMI In x 2, HDBaseT RJ45 In x 1, D-Sub 15Pin Out x 1, Stereo Mini Jack In x 2, Stereo Mini Jack Out x 1, USB Type A x 1, USB Type B x 1, RS-232C D-Sub 15Pin x 1, Wired Lan RJ45 x 1, HDMI Out x1
Network Optional [ELPAP11]	Power Consumption 312W/234W	Weight Approx 8.4 Kg

EB-L770U

Brightness 7,000 lm	Resolution WUXGA (16:10)	Contrast over 2,500,000 : 1
Light Source Life 20,000 hours	Keystone $\pm 30^\circ(V) / \pm 30^\circ(H)$	Connectivity D-Sub 15Pin IN x 2, HDMI In x 2, HDBaseT RJ45 In x 1, D-Sub 15Pin Out x 1, Stereo Mini Jack In x 2, Stereo Mini Jack Out x 1, USB Type A x 1, USB Type B x 1, RS-232C D-Sub 15Pin x 1, Wired Lan RJ45 x 1, HDMI Out x1
Network Optional [ELPAP11]	Power Consumption 366W/268W	Weight Approx 8.4 Kg

3LCD PROJECTOR

Business Projector

EB-L210W



Brightness 4,500lm / 3,100lm	Resolution WXGA (1280 x 800)	Contrast Over 2,500,000 : 1
Light Source Life 20,000 / 30,000 hrs	Keystone ±30° (V) / ±30° (H)	Connectivity -HDMI 2 (HDCP 2.3) -D-Sub 15Pin (1 [Black] lin common with Computer 2) -RCA 2 (White, Red) -Stereo Mini Jack (2) -USB Type A & B
Network -Wired LAN : RJ45 x 1 (100Mbps) -Wireless : Built-in*2 and Optional (Using ELPAP11)	Power Consumption -Lamp On (Normal / Extended) : 260W / 191W - Standby (Network On / Off) : 2.0W / 0.5W	Weight Approx. 4.2kg



30,000 Hours Lamp Life in Eco Mode



Split Screen



Auto Vertical Keystone



Horizontal Keystone Adjuster



Wi-Fi Connection



3LCD PROJECTOR

EB-L260F



Brightness 4,600lm / 3,200lm	Resolution Full HD (1080p)	Contrast Over 2,500,000 : 1
Light Source Life 20,000 / 30,000 hrs	Keystone ±30° (V) / ±30° (H)	Connectivity -HDMI 2 (HDCP 2.3) -D-Sub 15Pin (1 [Black] lin common with Computer 2) -RCA 2 (White, Red) -Stereo Mini Jack (2) -USB Type A & B
Network -Wired LAN : RJ45 x 1 (100Mbps) -Wireless : Built-in*2 and Optional (Using ELPAP11)	Power Consumption -Lamp On (Normal / Extended) : 260W / 191W - Standby (Network On / Off) : 2.0W / 0.5W	Weight Approx. 4.2kg



30,000 Hours Lamp Life in Eco Mode



Split Screen



Auto Vertical Keystone



Horizontal Keystone Adjuster



Wi-Fi Connection



3LCD PROJECTOR

Ultra Portable Projectors

EB-2065



Brightness 5,500lm	Resolution XGA	Contrast 15,000:1
Light Source Life 5,000 / 10,000 hrs	Keystone $\pm 30^\circ(V) / \pm 30^\circ(H)$	Connectivity HDMI in x2 [1 Support MHL] VGA in x2, VGA out x1 2RCA x1, RCA x1, RS-232C x1, RJ45 x1 Stereo Mini Jack in x2 Stereo Mini Jack out x1 USB Type-A & B x1
Network Optional (ELPAP10)	Power Consumption 425W / 323W	Weight 4.4 kg



Gesture
Presenter



Multi-PC
Projection



Wireless
Projection



Split Screen

EB-L520U



Brightness 5,200lm	Resolution WUXGA (1920 x 1200)	Contrast over 2,500,000 : 1
Light Source Life 20,000 hours	Keystone $\pm 30^\circ(V) / \pm 30^\circ(H)$	Connectivity D-Sub 15Pin IN x 2, HDMI In x 2, HDbaseT RJ45 In x 1, D-Sub 15Pin Out x 1, Stereo Mini Jack In x 2, Stereo Mini Jack Out x 1, USB Type A x 1, USB Type B x 1, RS-232C D-Sub 9Pin x 1, Wired Lan RJ45 x 1,
Network Optional (ELPAP11)	Power Consumption 293W/233W	Weight Approx 7.7 Kg



Split Screen

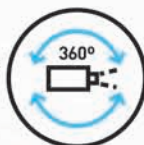

Flexible
360 degree
Installation

3LCD PROJECTOR

Extreme Short Throw Laser Projectors

3LCD PROJECTOR

EB-810E



Brightness 5,000lm / 3,500lm	Resolution 1080P (4K Enhancement)	Contrast Over 2,500,000 : 1
Light Source Life 20,000 / 30,000 hrs	Keystone ±30° (V) / ±30° (H)	Connectivity -HDMI 2 (HDCP 2.3) -HDBaseT 1 (HDCP 2.3) -USB Type A & B
Network -Wired LAN : RJ45 x 1 (100Mbps) -Wireless : Built-in and Optional (Using ELPAP11)	Power Consumption -Lamp On (Normal / Extended) : 380W / 286W - Standby (Network On / Off) : 2.0W / 0.4W	Weight Approx. 12.5kg



30,000 Hours Lamp Life in Eco Mode



Split Screen



Wide Screen Display (21:9)



Extreme Short Throw



Wi-Fi Connection



EB-815E



Brightness 5,000lm / 3,500lm	Resolution 1080P (4K Enhancement)	Contrast Over 2,500,000 : 1
Light Source Life 20,000 / 30,000 hrs	Keystone ±30° (V) / ±30° (H)	Connectivity -HDMI 2 (HDCP 2.3) -HDBaseT 1 (HDCP 2.3) -USB Type A & B
Network -Wired LAN : RJ45 x 1 (100Mbps) -Wireless : Built-in and Optional (Using ELPAP11)	Power Consumption -Lamp On (Normal / Extended) : 380W / 286W - Standby (Network On / Off) : 2.0W / 0.4W	Weight Approx. 12.5kg



30,000 Hours Lamp Life in Eco Mode



Split Screen



Wide Screen Display (21:9)



Extreme Short Throw



Wi-Fi Connection



3LCD PROJECTOR

Short Throw Projectors



EB-L210SW

Brightness 4,000lm / 2,800lm	Resolution WXGA (1280 x 800)	Contrast over 2,500,000 : 1
Light Source Life Type : Laser Diode Life (Normal / Quiet / Extended) : 20,000 / 20,000 / 30,000 hrs	Keystone ±15°(V) / ±15°(H)	Connectivity HDMI 2 (HDCP 2.3) D Sub 15 Pin RCA Stereo Mini Jack USB Type A & B
Network Wired LAN : RJ45 x 1 (100Mbps) Wireless : Built-in*2 and Optional wireless (using ELPAP11)	Power Consumption Lamp On (Normal / Extended) 260W / 191W Standby (Network On / Off) 2.0W / 0.5W	Weight Approx 4.6 Kg



Short Throw



30,000 Light Hours



Wi-Fi Connection



Multi-PC Projection

EB-L210SF



Brightness 4,000lm / 2,800lm	Resolution Full HD (1080p)	Contrast over 2,500,000 : 1
Light Source Life Type : Laser Diode Life (Normal / Quiet / Extended) : 20,000 / 20,000 / 30,000 hrs	Keystone ±15°(V) / ±15°(H)	Connectivity HDMI 2 (HDCP 2.3) D Sub 15 Pin RCA Stereo Mini Jack USB Type A & B
Network Wired LAN : RJ45 x 1 (100Mbps) Wireless : Built-in*2 and Optional wireless (using ELPAP11)*	Power Consumption Lamp On (Normal / Extended) 260W / 191W Standby (Network On / Off) 2.0W / 0.5W	Weight Approx 4.6 Kg



Short Throw



30,000 Light Hours



Wi-Fi Connection



Multi-PC Projection

3LCD PROJECTOR

Short Throw Projectors

EB-L630SU



Brightness 6,000 lm	Resolution WUXGA (16:10)	Contrast over 2,500,000 : 1
Light Source Life 20,000 hours	Keystone ±30°(V) / ±30°(H)	Connectivity D-Sub 15Pin IN x 2, HDMI In x 2, HDBaseT RJ45 In x 1, D-Sub 15Pin Out x 1, Stereo Mini Jack In x 2, Stereo Mini Jack Out x 1, USB Type A x 1, USB Type B x 1, RS-232C D-Sub 15Pin x 1, Wired Lan RJ45 x 1, HDMI Out x1
Network Built-In	Power Consumption 345W / 258W	Weight Approx 8.4 Kg



Wireless Projection



Flexible 360 degree installation



WUXGA Resolution



Edge Blending Technology



Lighting Scene

EB-W50



Brightness 3,800 lm	Resolution WXGA (1280 x 800)	Contrast 16,000:1
Light Source Life 10,000 hours (Normal), 17,000 hours (Eco)	Keystone ±30° (V) / ±30° (H)	Connectivity D-Sub 15 Pin In x 2, HDMI In x 2, D-Sub 15Pin Out x 1, Stereo Mini Jack In x 2, Stereo Mini Jack Out x 1, USB Type A x 1, USB Type B x 1, RS-232C D-Sub 9pin x 1, Wired LAN RJ45 x 1
Network Wireless ELPAP10 (Optional)	Power Consumption 285 W / 218 W	Weight 3.1 kg



17,000 Hours Lamp Life in Eco Mode



Split Screen



Auto Vertical Keystone



Dust Resistance Design



USB Direct Playback

3LCD PROJECTOR

Lighting Scene



EB-U50

Brightness 3,700 lm	Resolution WUXGA	Contrast 16,000:1
Light Source Life 10,000/17,000 hrs	Keystone ±30° (V) / ±30° (H)	Connectivity HDMI in x2, VGA in x2 VGA out x1, RJ45 x1 Stereo Mini Jack in x2 Stereo Mini Jack out x1 USB Type-A & Bx1
Network Built-in	Power Consumption 285W / 218W	Weight 3.1 kg



17,000 Hours
Lamp Life in Eco Mode



Split Screen



Auto Vertical
Keystone



Dust Resistance
Design



USB Direct
Playback

EV-110/EV-115



EV-110 (White)

EV-115 (Black)

Brightness 2,200lm	Resolution WXGA	Contrast >2,500,000:1
Laser Light Source 20,000 hrs	Keystone ±45°(V) / ±40°(H)	Connectivity HDMI in x1 SD Card x1, RJ45 x1 Stereo Mini Jack out x1 USB Type-A & Bx1
Network Built-in	Power Consumption 149W / 112W	Weight 6.9 kg (Exclude Direct Mount)

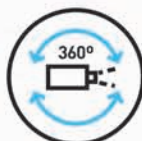

Flexible
Installation



Sleek Spotlight
Design

3LCD PROJECTOR



EB-800F / 805F

Brightness 5,000 lm	Resolution 1080p	Contrast over 2,500,000 : 1
Light Source Life 20,000 hours (Normal), 30,000 hours (Extended)	Keystone ±3° (V) / ±3° (H)	Connectivity D-Sub 15Pin In x 2, Composite In RCA x 1 (Yellow), HDMI In x 3 (HDCP2.3), HDBaseT x 1 (HDCP2.3), D-Sub 15Pin Out x 1, HDMI Out x 1, Stereo Mini Jack In x 3, Stereo Mini Jack Out x 1, Rs-232C D-Sub 9Pin x 1, USB Type A x 2, USB Type B x 1, Wired Lan RJ45 x 1
Network Wireless Lan x 1 USB Type A	Power Consumption 366 W / 262 W	Weight Approx 9.4 Kg



Full HD Resolution



Ultra short-throw
130 inch @80,3 cm



Multi-PC Projection



PC free
USB memory

Ultra Short Throw Lamp Projectors

EB-685W



Brightness 3,500 lm	Resolution WXGA	Contrast 14,000:1
Light Source Life 5,000/10,000 hrs	Keystone ±3° (V) / ±3° (H)	Connectivity HDMI in x3, RCA x1 VGA in x2, VGA out x1 RS-232C x1, RJ45 x1 Stereo Mini Jack out x1 Stereo Mini Jack in x3 USB Type-A & B x1 Microphone x1
Network Optional (ELPAP10)	Power Consumption 354W / 309W	Weight 5.7 kg



Ultra-Short
Throw



10,000 Hours
Lamp Life in Eco Mode



Multi-PC
Projection

3LCD PROJECTOR

Ultra Short Throw Lamp Projectors



**NEW
PRODUCT**

EB-760W

Brightness 4,100lm / 2,800lm	Resolution WXGA (1280 x 800)	Contrast over 2,500,000 : 1
Light Source Life Type : Laser Diode Life (Normal / Quiet / Extended) : 20,000 / 20,000 / 30,000 hrs	Keystone ±3°(V) / ±3°(H)	Connectivity HDMI Stereo Mini Jack USB Type A & B
Network Wired LAN RJ45 x 1 (100Mbps) Wireless Built-in and Optional (using ELPAP11)	Power Consumption Lamp On (Normal / Extended) 263W / 199W Standby (Network On / Off) 2.0W / 0.5W	Weight Approx 5.9 Kg



Ultra-Short
Throw



20,000 Light
Hours



Wireless
Connection



Multi-PC
Projection



**NEW
PRODUCT**

EB-770F

Brightness 4,100lm / 2,800lm	Resolution Full HD (1080p)	Contrast over 2,500,000 : 1
Light Source Life Type : Laser Diode Life (Normal / Quiet / Extended) : 20,000 / 20,000 / 30,000 hrs	Keystone ±3°(V) / ±3°(H)	Connectivity HDMI Stereo Mini Jack USB Type A & B
Network Wired LAN RJ45 x 1 (100Mbps) Wireless Built-in and Optional (using ELPAP11)	Power Consumption Lamp On (Normal / Extended) 263W / 199W Standby (Network On / Off) 2.0W / 0.5W	Weight Approx 5.9 Kg



Ultra-Short
Throw



20,000 Light
Hours



Wireless
Connection



Multi-PC
Projection



Full HD

3LCD PROJECTOR

EB-760Wi



Brightness 4,100lm / 2,800lm	Resolution WXGA (1280 x 800)	Contrast over 2,500,000 : 1
Light Source Life Type : Laser Diode Life (Normal / Quiet / Extended) : 20,000 / 20,000 / 30,000 hrs	Keystone ±3°(V) / ±3°(H)	Connectivity HDMI Stereo Mini Jack USB Type A & B
Network Wired LAN RJ45 x 1 (100Mbps) Wireless Built-in and Optional (using ELPAP11)	Power Consumption Lamp On (Normal / Extended) 263W / 199W Standby (Network On / Off) 2.0W / 0.5W	Weight Approx 6.0 Kg



Ultra-Short Throw



20,000 Light Hours



Wireless Connection



Multi-PC Projection



Optional Finger Touch Interactive

EB-770Fi



Brightness 4,100lm / 2,800lm	Resolution Full HD (1080p)	Contrast over 2,500,000 : 1
Light Source Life Type : Laser Diode Life (Normal / Quiet / Extended) : 20,000 / 20,000 / 30,000 hrs	Keystone ±3°(V) / ±3°(H)	Connectivity HDMI Stereo Mini Jack USB Type A & B
Network Wired LAN RJ45 x 1 (100Mbps) Wireless Built-in and Optional (using ELPAP11)	Power Consumption Lamp On (Normal / Extended) 263W / 199W Standby (Network On / Off) 2.0W / 0.5W	Weight Approx 6.0 Kg



Ultra-Short Throw



20,000 Light Hours



Wireless Connection



Multi-PC Projection



Full HD



Finger Touch Interactive

3LCD PROJECTOR

Ultra Short Throw Lamp Projectors

3LCD PROJECTOR

EB-695Wi Touch Interactive



Brightness 3,500 lm	Resolution WXGA	Contrast 14,000:1
Light Source Life 5,000/10,000 hrs	Keystone $\pm 3^\circ$ (V) / $\pm 3^\circ$ (H)	Connectivity HDMI in x3, RCA x1 VGA in x2, VGA out x1 RS-232C x1, RJ45 x1 Stereo Mini Jack out x1 Stereo Mini Jack in x3 Interactive Sync x1 USB Type-A & Bx1 Microphone x1
Network Optional (ELPAP10)	Power Consumption 354W / 309W	Weight 5.8 kg



Ultra-Short
Throw



10,000 Hours
Lamp Life in Eco Mode



Finger Touch
Interactive



Multi-PC
Projection

EB-1485Fi Touch Interactive



Brightness 5,000lm	Resolution 1080p	Contrast >2,500,000:1
Laser Light Source 20,000 hrs	Keystone $\pm 3^\circ$ (V) / $\pm 3^\circ$ (H)	Connectivity HDMI in x3 (HDCP2.3) HDBaseT x1 (HDCP2.3) HDMI out x1, RJ45 x1 VGA in x2, VGA out x1 Stereo Mini Jack in x3 Stereo Mini Jack out x1 RCA x1, RS-232C x1 Interactive Sync x1 Microphone x1, USB Type-A & Bx1
Network Built-in Support Screen Mirroring	Power Consumption 366W / 262W	Weight 9.3 kg



Ultra-Short
Throw



20,000 Light
Hours



Wireless
Connection



Multi-PC
Projection



Finger Touch
Interactive



Full HD

3LCD PROJECTOR

Large Venues

EB-PU1006W/ EB-PU1007W



Brightness 6.000 lm (PU1006W) 7.000 lm (PU1007W)	Resolution WUXGA	Contrast >2,500,000:1
Laser Source Life 20,000 hrs	Keystone ±45°(V) / ±30°(H)	Connectivity D-Sub 15Pin in x1, HDMI in x1, DVI-D in x1, HDBaseT, USB Type A x2 USB Type B x1, RS-232C x1, Stereo Mini Out x1, RJ45
Network Wireless Optional (ELPAP11)	Power Consumption 367W (PU1006W) 431W (PU1007W)	Weight 15.4 kg (PU1006W) 16.3 kg (PU1007W)



HDBaseT

Edge
Blending

360°
Flexible
Installation

NFC

EB-PU1008B/ EB-PU2010B



Brightness 8.500 lm (PU1008B) 10.000 lm (PU2010B)	Resolution WUXGA	Contrast >2,500,000:1
Laser Source Life 20,000 hrs	Keystone ±45°(V) / ±30°(H)	Connectivity D-Sub 15Pin in x1, HDMI in x1, DVI-D in x1, HDBaseT, USB Type A x2 USB Type B x1, RS-232C x1, Stereo Mini Out x1, RJ45, SDI x1 (for PU2010B)
Network Wireless Optional (ELPAP11)	Power Consumption 535W	Weight 16.3 kg (PU1008B) 16.8 kg (PU2010B)



HDBaseT

Edge
Blending

360°
Flexible
Installation

NFC

3LCD PROJECTOR

Large Venues

3LCD PROJECTOR

EB-PU2213B



Brightness 13,000lm	Resolution WUXGA	Contrast >2,500,000:1
Laser Source Life 20,000 hrs	Keystone ±45°(V) / ±30°(H)	Connectivity HDMI in x1, SDI x1 HDBaseT x1 VGA in x1, VGA out x1 5BNC x1, DVI-D x1 RS-232C x1, RJ45 x1 Stereo Mini Jack in x3 Stereo Mini Jack out x1 USB Type-A & Bx1
Network Wireless optional (ELPAP10)	Power Consumption 908W / 597W	Weight 21.9 kg



HDBaseT

Flexible
Installation

Edge
Blending

EB-PU2216B



Brightness 16,000lm	Resolution WUXGA	Contrast >2,500,000:1
Laser Source Life 20,000 hrs	Keystone ±45°(V) / ±30°(H)	Connectivity HDMI in x1 HDBaseT x1 VGA in x1, VGA out x1 5BNC x1, DVI-D x1 RS-232C x1, RJ45 x1 Stereo Mini Jack out x3 USB Type-A & Bx1
Network Wireless optional (ELPAP10)	Power Consumption 1024W / 647W	Weight 22.3 kg



HDBaseT

Edge
Blending

Flexible
Installation

3LCD PROJECTOR

EB-PU2220B



Brightness 20,000lm	Resolution WUXGA	Contrast >2,500,000:1
Laser Source Life 20,000 hrs	Keystone $\pm 44^\circ(V) / \pm 30^\circ(H)$	Connectivity HDBaseT x1, RS-232C x1 VGA in x1, VGA out x1 BNC in x1, SDI in x1 Expansion Board ELPIF01 (HDMI in x1, DVI-D x1, DC-Out x1) Expansion Board ELPIF03 (Display port in x2) BNC out x1 RJ-45 x1 (etherCON) USB Type-A & B x1
Network Built-in	Power Consumption 1860W / 1123W	Weight 49.6 kg



HDBaseT

Flexible Installation

Edge Blending

EB-L30000UNL



Brightness 30,000lm	Resolution WUXGA	Contrast >2,500,000:1
Laser Source Life 20,000 hrs	Keystone $\pm 45^\circ(V) / \pm 30^\circ(H)$	Connectivity HDBaseT x1 (HDCP 2.2) VGA in x1, VGA out x1 SDI in x1, 5BNC x1 DVI-D x1 (Single link, HDCP 1.4) HDMI in x1 (HDCP 2.2) SDI out x1, RS-232C x1 Remote x1, RJ45 x1 USB Type-A & B x1
Network Optional	Power Consumption 2325W / 1511W	Weight 69.9 kg



HDBaseT

Flexible Installation

Edge Blending

3LCD PROJECTOR

Large Venues

EB-PQ2010B/ EB-PQ2220B

3LCD PROJECTOR

NEW
PRODUCT



Brightness 10,000 lm (PQ2010B) 20,000 lm (PQ2220B)	Resolution 4K UHD (3840 x 2160)	Contrast >5,000,000:1
Laser Source Life 20,000 hrs	Keystone ±45°(V) / ±30°(H)	Connectivity SDI (BNC) x1, HDMI in x2, HDBaseT x1, USB Type A x2, USB Type B x1, RS-232 C x1, Stereo Mini Jack in x1, SDI out (BNC) x1, HDMI out x1, Stereo Mini Jack Out x1
Network LAN RJ45 x1 Wireless Optional (ELPAP11)	Power Consumption 613W/483W (PQ2010B) 1,431W/975W (PQ2220B)	Weight 18.8 kg (PQ2010B) 29.2 kg (PQ2220B)



HDBaseT

Edge
Blending

Flexible
Installation

NFC

Home Entertainment Projectors

EH-QL3000W

NEW
PRODUCT



Brightness 6,000lm	Resolution 4K	Contrast > 5,000,000:1
Laser Light Source 20,000 hrs	Keystone ±30° (V) / ±30° (H)	Connectivity HDMI x 2 USB Type-A x 2 USB Type-B x 1 Stereo Mini Jack Out x 1
Network LAN RJ45 x1	Power Consumption 453W/357W	Dimension Approx. 21kg 570 x 560 x 190 mm



4K

HDR
High Dynamic Range

HDRiC+



Lens Shift

3LCD PROJECTOR

Home Entertainment Projectors

3LCD PROJECTOR

NEW
PRODUCT



EpiqVision EF-21G/R

Brightness 1,000lm	Resolution Full HD (1080p)	Contrast > 5,000,000: 1
Weight Approx 2.3 kg	Keystone $\pm 20^\circ$ (V) / $\pm 20^\circ$ (H)	Connectivity HDMI x1 (HDCP 2.3) 5 W Stereo Speaker USB Type-A & Type-B x1



Auto Vertical Keystone



Miracast



NEW
PRODUCT



EpiqVision EF-22N

Brightness 1,000lm	Resolution Full HD (1080p)	Contrast > 5,000,000: 1
Weight Approx 2.3 kg	Keystone $\pm 20^\circ$ (V) / $\pm 20^\circ$ (H)	Connectivity HDMI x1 (HDCP 2.3) 5 W Stereo Speaker USB Type-A & Type-B x1



Auto Vertical Keystone



Miracast



3LCD PROJECTOR

Home Entertainment Projectors

3LCD PROJECTOR



EpiqVision EF-11

Brightness 1,000lm	Resolution Full HD (1080p)	Contrast > 2,500,000:1
Weight Approx 1.2 kg	Keystone ±34° (V) / ±40° (H)	Connectivity HDMI x1 (HDCP 1.4) Stereo Mini Jack Out x1 USB Type-A & Type-B x1



Auto Vertical Keystone



Miracast



EpiqVision EF-12

Brightness 1,000lm	Resolution Full HD (1080p)	Contrast > 2,500,000:1
Weight Approx 2.1 kg	Keystone ±34° (V) / ±40° (H)	Connectivity HDMI x1 (HDCP 1.4) Stereo Mini Jack Out x1 USB Type-A & Type-B x1



AndroidTV



Miracast

sound by YAMAHA

3LCD PROJECTOR

EH-TW6250



Brightness 2,800lm / 1,900lm	Resolution Full HD (1080P)	Contrast 35,000 : 1
Light Source Life Type Lamp: 200W UHE Lamp Life*1 Normal: 4,500 / Eco: 7,500 hours	Keystone ±30°(V) / ±30°(H)	Connectivity HDMI USB Type B
Network -	Power Consumption Lamp On (Normal/ Quiet, Extended) 301W / 231W Energy Saving 0.3W	Weight Approx 4.1 Kg



Auto Vertical Keystone



AndroidTV

EH-LS800B



Brightness 4,000lm / 2,000lm	Resolution 4K	Contrast Over 2,500,000:1
Light Source Life 20,000 hours (Normal / Eco)	Keystone -	Connectivity HDMI USB Type A
Network -	Power Consumption Lamp On (Normal/ Quiet, Extended) 335W / 210W Standby (Network On / Off) 2.0W / 0.4 W*	Weight Approx 7.2 Kg



AndroidTV

sound by YAMAHA

Chromecast built-in

3LCD PROJECTOR

Home Entertainment

EpiqVision Ultra EH-LS650B



Android TV™ Dongle (ELPAP12)
sudah ada di dalam unit nya



sound by **YAMAHA**

Chromecast built-in

Brightness 3,600lm	Resolution Full HD (1080p)	Contrast > 2,500,000:1
Laser Light Source 20,000 hrs	Keystone 8 point arc correction	Connectivity HDMI x2 (SMF, HDMI2=ARC) Audio Out (Bluetooth & Optical Out) USB Type-A x 1 USB Type-B Mini x1
Wireless Built-in	Power Consumption 278 W	Weight & Dimension Approx. 7.2 kg 400x467x133 mm

EH-LS12000B



Brightness 2,700lm	Resolution 4K	Contrast > 2,500,000:1
Laser Light Source 20,000 hrs	Keystone ±30° (V) / ±30° (H)	Connectivity HDMI x 2 USB Type-A x 2 USB Type-B x 1 Stereo Mini Jack Out x 1
Network N/A	Power Consumption 302W/198W	Dimension Approx. 12.7kg 447 x 520 x 169 mm



4K

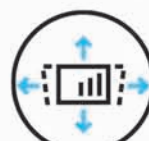

Lens Shift

3LCD PROJECTOR

EH-TW7000



Brightness 3,000lm	Resolution Full HD (1080p)	Contrast 40,000:1
Light Source Life 3,500 hrs / 5,000 hrs	Keystone ±30° (V) / ±30° (H)	Connectivity HDMI x 2 (HDCP 2.2) Stereo Mini Jack Out x 1 USB Type-A x 2 Type-B Mini x 1 Wireless ELPAP10 (Optional)
Max Screen Size 500 inch	Power Consumption 368W/280W	Weight & Dimension Approx 6.6 kg 410 x 310 x 157 mm

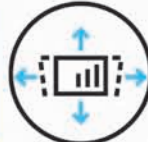

Vertical & Horizontal
Keystone Adjuster



HDMI



EH-TW9400



Brightness 2,600lm	Resolution 4K	Contrast 1,200,000:1
Light Source Life 3,500 hrs / 5,000 hrs	Keystone ±30° (V)	Connectivity HDMI x 2 (HDCP 2.2) Stereo Mini Jack Out x 1 USB Type-A x 2 Type-B Mini x 1 Wireless ELPAP10 (Optional)
Max Screen Size 300 inch	Power Consumption 355W / 271W	Weight & Dimension Approx. 11.2 kg 520 x 170 x 450 mm



Lens Shift

3LCD PROJECTOR

Cross Over

3LCD PROJECTOR



CO-FH01

Brightness 3,000lm / 2,000lm	Resolution Full HD (1080P)	Contrast -
Light Source Life -	Keystone ±30°(V) / ±30°(H)	Connectivity HDMI USB Type A & B
Network Wireless Optional (ELPAP11)	Power Consumption 270W / 214W	Weight Approx 2.4 Kg

Full HD
1080p

CO-FH02



Brightness 3,000lm / 2,000lm	Resolution Full HD (1080P)	Contrast -
Light Source Life Type Lamp (Fixed), 188 W UHE Life (Normal/ Extended) 6,000 / 12,000 hours (Normal / ECO)	Keystone ±30°(V) / ±30°(H)	Connectivity USB Type A & B
Network -	Power Consumption 270W / 214W	Weight Approx 2.6 Kg

Full HD
1080p



Chromecast built-in

3LCD PROJECTOR

Wireless Presenter



ELPWP10

Ideal for small-group presentation, Selected Epson projectors offers an affordable and versatile wireless presentation system for offices.

[Contents: Wireless Dongle x2, ELPAP11 x1, Tray x1)



ELPWP20

- Cable-free collaboration Wireless presentation system for maximum ease of use
- Instant multi-screen sharing Display up to four devices simultaneously
- Display-agnostic Compatible with all displays with a HDMI input
- Compatibility with all major OSs Works with Windows, Mac, Android, iOS and Chromebooks
- Miracast built in For simple sharing on compatible devices

[Contents: Wireless Dongle x2, Base Station x1, Tray x1, IR Remote x1)



ELPWT01

- Power Consumption 5 VDC / 0.5 A
- Operating Temperature 0 to +40°C (Humidity of 20 to 80%, No condensation)
- Storage Temperature -20 to +70°C (Humidity of 0 to 95%, No condensation)
- Operating Altitude 0 to 3,000 m
- Dimensions Width 63.5 x Height 11 x Depth 175 mm (excluding USB conversion adapter)
- Weight Approx. 53 g

[Contents: Wireless Dongle x1)

TM PRINTER



**POS
PRINTER**

13 YEARS RUNNING
2009-2021

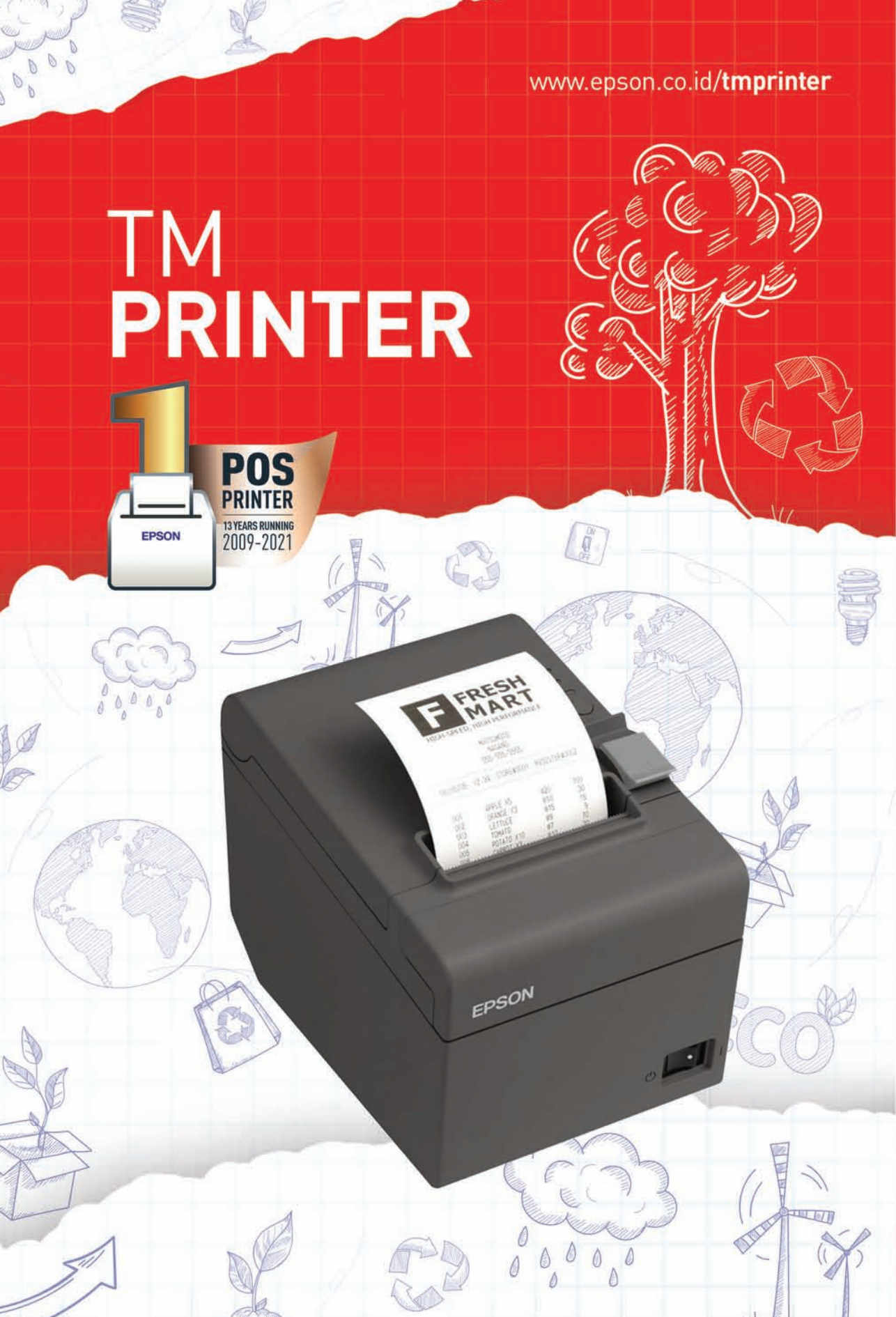

TM PRINTER

TM-M30III

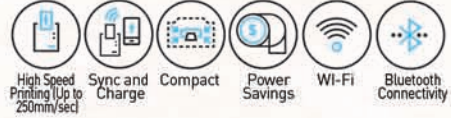

**NEW
PRODUCT**

- Print Method** Thermal Line Printing
- Print Speed** 250 mm/sec
- Interface** USB + Ethernet/ USB + Ethernet + Bluetooth/ 3.0 EDR
- Paper Dimension** Roll Paper: 57.5 ± 0.5 (w) x Ø 40.4 mm
- Operating System** Mobile IOS, Android and Windows, (security LEVELWEP, WPA, WPA2-Personal/Enterprise)
- Power Consumption** 32.4 W
- Overall Dimension** 127 x 127 x 135 mm
- Weight** 1.3 Kg

EU-M30



- Print Method** Thermal Line Printing
- Print Speed** 250 mm/sec
- Interface** USB 2.0 Type B, RS-232C
- Paper Size** 58 mm - 80 mm (Width)
- Paper size roll paper** 57.50 ± 0.50 (W) mm x dia 18.00 mm, 57.50 ± 0.50 (W) mm x dia 83.00 mm, 79.50 ± 0.50 (W) mm x dia 18.00 mm, 79.50 ± 0.50 (W) mm x dia 83.00 mm
- Operating System** Mobile IOS, Android and Windows, (security LEVELWEP, WPA, WPA2-Personal/Enterprise)
- Power Supply** AC adapter, C, EURO AC cable
- Overall Dimension** 127 x 131 x 127 mm
- Weight** 1.3 kg



TM PRINTER

Mobile (Portable) Receipt Printer

TM PRINTER

TM-P20II Mobile



Mobility



Print



Power Savings



Print Method
Print Speed
Character Size

Thermal Line Printing
100 mm/sec (Receipt Version)
font A: 1.5 x 3.0 mm;
font B: 1.12 x 3.0 mm;
font C: 1.12 x 2.1 mm;
font D: 1.25 x 3.0 mm;
font E: 1.0 x 2.0 mm

Paper Dimension
Operating System

Roll Paper: 57.5 ± 0.5 (w) x Ø 40.4 mm
Mobile iOS, Android and Windows, (security LEVELWEP, WPA, WPA2-Personal/Enterprise

Power Consumption

Wi-Fi: 9 hours (energy saving mode): 16 hours |
Bluetooth: 26 hours

Overall Dimension
Option

79.0 x 119.8 x 43.6 mm
Single Printer Charger/Cradle (OT-SC20),
Battery Pack (OT-BY20), Padded Case (OT-PC20),
Battery Spacer (OT-BS20)

TM-P80II



Mobility



Print



Power Savings



Print Method
Print Speed
Character Size

Thermal Line Printing
100 mm/sec (Receipt Version)
font A: 1.5 x 3.0 mm;
font B: 1.12 x 3.0 mm;
font C: 1.12 x 2.1 mm;
font D: 1.25 x 3.0 mm;
font E: 1.0 x 2.0 mm

Paper Dimension
Operating System

Roll Paper: 57.5 ± 0.5 (w) x Ø 40.4 mm
Mobile iOS, Android and Windows, (security LEVELWEP, WPA, WPA2-Personal/Enterprise

Power Consumption

Wi-Fi: 9 hours (energy saving mode): 16 hours |
Bluetooth: 26 hours

Overall Dimension
Option

79.0 x 119.8 x 43.6 mm
Single Printer Charger/Cradle (OT-SC20),
Battery Pack (OT-BY20), Padded Case (OT-PC20),
Battery Spacer (OT-BS20)

TM PRINTER

Receipt Printers

TM-M30II-SL



Mobility



Print



Power Saving



Auto Cutter



Print Method Thermal line printing
Print Speed 200 mm/sec (Receipt Version)
Character Size ANK Font A: 1.25 x 3 mm (Default); ANK Font B: 1.13 x 3 mm; Kanji Font: 3 x 3 mm

Paper Dimension Roll paper: 79.5 ± 0.5 (W) x Ø 83, 57.5 ± 0.5 (W) x Ø 83

Interface Built-in USB + Ethernet 10/100Base-T/TX (Ethernet Model)

Power Consumption Approx. 1.5 A (mean)

Overall Dimension 127 x 127 x 127 mm

Option External Buzzer (OT-BZ20); Wall Hanging Bracket (OT-WH30)

TM-U220



Print



Power Saving



Print Method 9-pin, serial impact dot matrix
Print Speed Approx. 4.7 lps (at 40 columns, 16 cpi), 6.0 lps (at 30 columns, 16 cpi)

Character Size Font A: 1.6 mm (W) x 3.1 mm (H)
Font B: 1.2 mm (W) x 3.1 mm (H)

Paper Dimension Roll Paper : 57.5 ± 0.5 (W), 69.5 ± 0.5 (W), 76.0 ± 0.5 (W) x Ø 83.0 mm

Interface RS 232, Bi-directional Parallel, USB, Ethernet

Power Consumption Operating: Approx. 38 W (Mean)
Standby: Approx. 2.2 W (Mean)

Overall Dimension Type A: 160 (W) x 286 (D) x 157.5 (H) mm

Type B: 160 (W) x 248 (D) x 138.5 (H) mm

Type B: 160 (W) x 248 (D) x 138.5 (H) mm

Option Wall hanging bracket model: WH-10 (for type B, D)

TM PRINTER

Receipt Printers

TM PRINTER

TM-T82X



Mobility



Print



Power Saving



Auto Cutter



Also available for 58mm paper width

Print Method	Thermal Line Printing
Print Speed	Max. 200 mm/sec
Character Size	0.88 x 2.13 mm / 1.25 x 3 mm, Hanji font: 3 x 3 mm, Thai font: 0.88 x 3 mm / 1.25 x 3 mm
Paper Dimension	Width and Roll Diameter: 79.5 ± 0.5 mm
Operating System	Windows, Mac, Linux
Power Consumption	Operating: Approx. 27.8 W Standby: Approx. 0.96 W
Overall Dimension	192 x 149 x 140 mm
Option	External buzzer

TM-T82III



Mobility



Print



Power Saving



Auto Cutter



Print Method	Thermal Line Printing
Print Speed	Max. 250 mm/sec
Character Size	0.88 x 2.13 mm / 1.25 x 3 mm, Hanji font: 3 x 3 mm, Thai font: 0.88 x 3 mm / 1.25 x 3 mm
Paper Dimension	Width: 79.5 ± 0.5mm Roll: 57.5 ± 0.5 x Ø 83.0 mm
Interface	Built-in USB + UIB (Serial or Parallel interface), Ethernet interface
Power Consumption	Operating: Approx. 1.5A Standby: Approx. 0.1A
Overall Dimension	199 x 140 x 146 mm
Option	External Wi-Fi Dongle OT-WL06, External buzzer unit

TM PRINTER

TM-88VII



Mobility



Print



Power Saving



Auto Cutter



- Print Method** Thermal Line Printing
- Print Speed** Max. 350 mm/sec
- Character Size** 0.99 x 2.4 mm / 1.41 x 3.39 mm
- Paper Dimension** 79.5 ± 0.5 mm x 83.0 / 57.5 ± 0.5 x 83.0 mm
- Interface** Built-in USB, Built-in Ethernet + UIB
- Power Consumption** Approx. 27.6 W
- Overall Dimension** 195 x 145 x 148 mm
- Option** Wireless LAN: OT-WL02 (ELPAP10)
Customer Display Unit: DM-D30, DM-D110
Wall Hanging Unit: WH-10
External Buzzer: OT-BZ20

Slip Printer

TM-U295



Mobility



Print



Power Saving



Auto Cutter



- Print Method** 7-pin, Shuttle Impact Dot Matrix
- Print Speed** Approx. 1.9 - 2.3 lps
- Character Size** 1.6 (W) x 2.9 (H) / 1.3 (W) x 2.9 (H) mm
Thai Font Size: 1.6 (W) x 8.7 (H) / 1.9 (W) x 8.7 (H) mm
- Paper Dimension** 80(W) x 69(L) to 182 (W) x 257 (L) mm
- Interface** RS-232 / Bi-directional Parallel
- Power Consumption** Approx. 600 mA (mean)
- Reliability** MCBF: 7,000,000 lines
Autocutter: -
- Overall Dimension** 180 x 290.5 x 101.5 mm

TM PRINTER

Receipt Printers

TM-L90



Mobility



Print



Power Saving



Auto Cutter



Technology	Thermal line
Print Resolution	203 x 203 dpi
Type Width	Receipt: Max. 72 mm Label: Max. 70 mm
Max. Print Speed	Max. 150 mm/sec
Interface	Built-in USB + 25-pin serial, with optional parallel and ethernet interface modules
Operating System	Microsoft Windows 8 / 7 / Vista/ XP / POS Ready / Server 2012 / Server 2008 / Server 2003
Power Consumption	Operating: Approx. 1.8 A (mean) Standby: Approx. 0.1 A
Overall Dimension	148 x 140 x 203 mm
Weight	Approx. 1.9 kg

PEELER & LFC MODEL ALSO AVAILABLE

TM-L100



Mobility



Print



Power Saving



Auto Cutter



Technology	Thermal line
Print Resolution	203 x 203 dpi
Type Width	Receipt: Max. 72 mm Label: Max. 70 mm
Max. Print Speed	Max. 150 mm/sec
Interface	Built-in USB + 25-pin serial, with optional parallel and ethernet interface modules
Operating System	Microsoft Windows 8 / 7 / Vista/ XP / POS Ready / Server 2012 / Server 2008 / Server 2003
Power Consumption	Operating: Approx. 1.8 A (mean) Standby: Approx. 0.1 A
Overall Dimension	148 x 140 x 203 mm
Weight	Approx. 1.9 kg

PEELER & LFC MODEL ALSO AVAILABLE

TM PRINTER

Receipt & Slip Printer

TM-H6000VI



Mobility



Print



Power Saving



Auto Cutter



Print Method 9-pin serial impact dot matrix
Print Speed 350 mm/sec
Character Size 1.41 mm (W) x 3.39 mm (H) / 0.99 mm (W) x 2.4 mm (H)

Paper Dimension 79.50 ± 0.50 (W) mm x Ø 83.00 mm;

57.50 ± 0.50 (W) mm x Ø 83.00 mm

Interface RS-232, USB 2.0 Type B, Drawer kick-out,

Customer Display

Power Consumption Approx. 22W

Overall Dimension 186 x 278 x 181 mm

Option Endorsement printer (E/P), MICR device, Validation

TM Printer Consumable

TM CONSUMABLE

Material Code	Description
C43S015352	ERC-05(B) RIBBON CASSETTE
C43S015354	ERC-09(B) RIBBON CASSETTE
C43S015358	ERC-22(B) RIBBON CASSETTE
C43S015366	ERC-27(B) RIBBON CASSETTE
C43S015369	ERC-31(B) RIBBON CASSETTE
C43S015371	ERC-32(B) RIBBON CASSETTE
C43S015374	ERC-38(B) RIBBON CASSETTE
C43S015376	ERC-38(B/R) RIBBON CASSETTE
C43S015377	RIBBON CASSETTE ERC-38(B) STD 10 -1PK

NEXT-GENERATION POS SOLUTIONS FOR YOUR BUSINESS.



Thermal
Desktop Printers



Portable
Thermal Printers



Thermal
Label Printers



Dot Matrix
Printers



Hybrid
Printers

ENGINEERED FOR good

EPSON

LABEL INKJET PRINTER

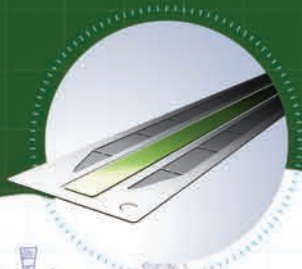

**BE
BOLD**
WITH ON DEMAND
LABELS



LABEL INKJET PRINTER

MENGAPA MEMILIH LABEL INKJET PRINTER ?

Epson Label Inkjet Printer menghadirkan label warna berkualitas tinggi sesuai kebutuhan untuk meningkatkan efisiensi dan mengurangi biaya pelabelan. Dengan cetakan tinggi kecepatan hingga 103mm per detik, resolusi dan keandalan yang sangat baik, printer ini adalah pilihan yang sempurna untuk industri, kimia, pergudangan, aplikasi pelabelan medis dan lainnya.

Superior Print Quality

Memastikan hasil cetak gambar yang tajam di setiap label. Epson MicroPiezo® inkjet technology dengan tinta pigmen kami memastikan label yang jernih, teks yang jelas, mudah dibaca, barcode dan grafik yang dinamis yang tahan lama, cepat kering dan tahan luntur. Hasil cetak tahan terhadap noda dan air, bahkan di atas kertas.

Epson pigment ink

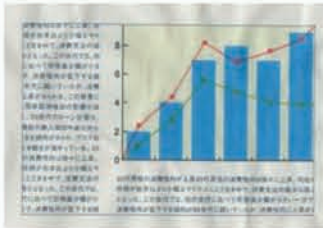

Dye-based ink

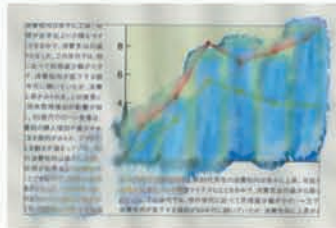

Berbagai Macam Media

Cetak pada berbagai bahan dan nikmati label warna sesuai kebutuhan. Mulai dari polos, sintetis, matte ke glossy, Printer label Epson memastikan label dengan kualitas cetak superior, memberi Anda gambar yang tajam. Printer label ini juga dapat mencetak pada bahan gulungan, lipatan, die cut atau bahan label bersambung.



Premium matte Ticket



Premium matte label



PE matte label

ENGINEERED FOR good

EPSON

BE
BOLD

**WITH ON DEMAND
LABELS**

DO LABELS DIFFERENTLY

Customisable labels

High productivity print in short or limited batches

Rich, vibrant colours

Superb accuracy and gradation, down to the finest details

Durability that lasts

Quality labels that weather any conditions

Streamlined efficiency

Eliminating the need for dual-stage printing



LABEL INKJET PRINTER

ColourWorks Label Inkjet Printers

CW-C4050

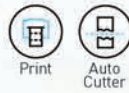

Print Technology	Serial Inkjet PrecisionCore TFP® with Nozzle Verification Technology
Print Resolution	Up to 1,200 x 1,200 dp
Colour	CMYK + Matte Black
Printing Width	Max. 108 mm
Printing Speed	Max. Speed (300x600dpi): 100mm/sec Max. Speed for Glossy Media (600x600dpi): 48mm/sec when printing 101.6mm Width
Interfaces	Hi-Speed USB 2.0 and Ethernet (100BASE-TX /10BASE-T) [Use of Optional product OT-WL06]
Media Type	Plain, Matte, Textured, Synthetic, Glossy, High glossy, Wristband
External Roll Diameter	Max. 101.6 mm
Power Consumption	Printing: Approx. 28.2W (mean) Standby: Approx. 2.6W (mean)
Dimensions	283 x 310 x 285 mm
Weight	Approx. 13.0 kg

CW-C7510G

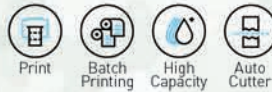

Print Technology	PrecisionCore TFP® with Nozzle Verification Technology
Print Resolution	1,200 x 600 dpi
Colour	CMYK
Printing Width	4.1" (104mm) max.
Printing Speed	300 mm/sec.
Interfaces	USB 2.0 High-Speed, Ethernet 10/100 BASE-T Extended: Dsub-15 pin
Media Type	Plain, matte, synthetic, glossy
External Roll Diameter	Max. 203.2 mm
Power Consumption	Printing: Approx. 84W Standby: Approx. 5.1W
Dimensions	392 x 598 x 395 mm
Weight	Approx. 37.0 kg

LABEL INKJET PRINTER

ColourWorks Label Inkjet Printers

CW-C6050A



- Print Technology** Serial Inkjet PrecisionCore TFP® with Nozzle Verification Technology
- Print Resolution** 1,200 x 1,200 dpi (Max.)
- Colour** CMYK
- Printing Width** Max. 108 mm
- Printing Speed** Max speed (300x600dpi): 119 mm/sec.
Max speed for Glossy media (600x600dpi): 48 mm/sec; *When printing 101.6 mm width
- Interfaces** USB 2.0 High-Speed, Ethernet 10/100 BASE-T
Extended: Dsub-25 pin
- Media Type** Matte, synthetic, glossy, high glossy
- External Roll Diameter** Max. 203.2 mm
- Power Consumption** Printing: Approx. 39.4W
Standby: Approx. 7.51W
- Dimensions** 565 x 340 x 326 mm
- Weight** Approx. 22.5 kg



Total Nilai TKDN + BMP
26.07%

CW-C6050P



- Print Technology** Serial Inkjet PrecisionCore TFP® with Nozzle Verification Technology
- Print Resolution** 1,200 x 1,200 dpi (Max.)
- Colour** CMYK
- Printing Width** Max. 108 mm
- Printing Speed** Max speed (300x600dpi): 119mm/sec.
Max speed for Glossy media (600x600dpi): 48 mm/sec. *When printing 101.6 mm width
- Interfaces** US 2.0 High-Speed, Ethernet 10/100 BASE-T
Extended: Dsub-25 pin
- Media Type** Matte, synthetic, glossy, high glossy
- External Roll Diameter** Max. 203.2 mm
- Power Consumption** Printing: Approx. 39.4W
Standby: Approx. 7.51W
- Dimensions** 565 x 340 x 326 mm
- Weight** Approx. 22.8 kg



Total Nilai TKDN + BMP
27.18%

LABEL INKJET PRINTER

ColourWorks Label Inkjet Printers

CW-C6550A



Total Nilai
TKDN + BMP
25.83%

Print Technology	Serial Inkjet PrecisionCore TFP® with Nozzle Verification Technology
Print Resolution	1,200 x 1,200 dpi (max.)
Colour	CMYK
Printing Width	Max. 211.9mm (A4 Size)
Printing Speed	Max speed (300x600dpi): 85 mm/sec. Max speed for Glossy media (600x600dpi): 34 mm/sec. *When printing 203.2 mm width
Interfaces	US 2.0 High-Speed, Ethernet 10/100 BASE-T Extended: Dsub-25 pin
Media Type	Matte, synthetic, glossy, high glossy
External Roll Diameter	Max. 152.4 mm
Power Consumption	Printing: Approx. 38.7W Standby: 5.82W
Dimensions	515 x 444 x 326 mm
Weight	Approx. 25.5 kg

CW-C6550P



Total Nilai
TKDN + BMP
25.62%

Print Technology	Serial Inkjet PrecisionCore TFP® with Nozzle Verification Technology
Print Resolution	1200 x 1200 dpi (max.)
Colour	CMYK
Printing Width	Max. 211.9mm (A4 Size)
Printing Speed	Max speed (300x600dpi): 85 mm/sec. Max speed for Glossy media (600x600dpi): 34 mm/sec. *When printing 203.2 mm width
Interfaces	US 2.0 High-Speed, Ethernet 10/100 BASE-T Extended: Dsub-25 pin
Media Type	Matte, synthetic, glossy, high glossy
External Roll Diameter	Max. 152.4 mm
Power Consumption	Printing: Approx. 38.7W Standby: 5.82W
Dimensions	515 x 444 x 326 mm
Weight	Approx. 26.3 kg

LABEL INKJET PRINTER

ColourWorks Label Inkjet Printers

LABEL INKJET PRINTER

CW-C8050



Print Technology	Serial Inkjet PrecisionCore TFP® with Nozzle Verification Technology
Print Resolution	1,200 x 1,200 dpi (max.)
Colour	CMYK
Printing Width	Max. 211.9mm (A4 Size)
Printing Speed	Max speed (300x600dpi): 85 mm/sec. Max speed for Glossy media (600x600dpi): 34 mm/sec. *When printing 203.2 mm width
Interfaces	US 2.0 High-Speed, Ethernet 10/100 BASE-T Extended: Dsub-25 pin
Media Type	Matte, synthetic, glossy, high glossy
External Roll Diameter	Max. 152.4 mm
Power Consumption	Printing: Approx. 38.7W Standby: 5.82W
Dimensions	515 x 444 x 326 mm
Weight	Approx. 25.5 kg

**BE
BOLD**
WITH ON DEMAND
LABELS



**Buat label cetakan versi Anda
tanpa perlu waktu lama**

Desain, edit, dan cetak label secara instan

LABEL INKJET PRINTER

ColorWorks Label Inkjet Printer Consumable

Material Code	Description	Compatibility
ColorWorks Label InkJet Printer Consumable		
C33S020464	SJIC15P-464	TM-C3400
C33S020490	SJIC20P(K)-490: Ink Cartridge for TM-C3400BK	TM-C3400 BK
C33S020580	SJMB3500: Maintenance Box	TM-C3510
C33S020578	SJIC23P(K): Ink Cartridge for TM-C3510	
C33S020584	SJIC23P(C): Ink Cartridge for TM-C3510	
C33S020585	SJIC23P(M): Ink Cartridge for TM-C3510	
C33S020586	SJIC23P(Y): Ink Cartridge for TM-C3510	
C13S020559	GJIC4(K) Ink BK for Liatris-II	GP-C 830 / GP-M 830
C13S020560	GJIC4(C) Ink C for Liatris-II	GP-C 830
C13S020561	GJIC4(M) Ink M for Liatris-II	
C13S020562	GJIC4(Y) Ink Y for Liatris-II	
C33S020464	SJIC15P: 3-Colour for TM-C3400, Pigment Ink	TM-C3400
C33S020643	SJIC31P(K): Ink Cartridge	TM-C7510G
C33S020644	SJIC31P(C): Ink Cartridge	
C33S020645	SJIC31P(M): Ink Cartridge	
C33S020646	SJIC31P(Y): Ink Cartridge	
C33S020596	SJMB7500:MAINTENANCE BOX (C7500 Series)	
C13T44G100	SJIC40P-K: Ink Cartridge 70ml	CW-C6050/C6550
C13T44G200	SJIC40P-C: Ink Cartridge 70ml	
C13T44G300	SJIC40P-M: Ink Cartridge 70ml	
C13T44G400	SJIC40P-Y: Ink Cartridge 70ml	
C33S021501	SJMB6000: MAINT. BOX FOR CW-C6050/C6550	CW-C6050/C6550
C13T52R100	SJIC46P-BK ink	CW-C4050
C13T52R200	SJIC46P-C ink	
C13T52R300	SJIC46P-M ink	
C13T52R400	SJIC46P-Y ink	
C13T52R500	SJIC46P-MK ink	
C33S021601	SJMB4000	



LABEL PRINTER

MENGAPA MEMILIH EPSON LABEL PRINTER ?

Dari organisasi rumah dan kantor yang sederhana hingga penandaan sistematis aset untuk sekolah, pabrik, rumah sakit, dan lainnya, Printer Epson LabelWorks menawarkan solusi profesional yang mudah digunakan untuk setiap kebutuhan pelabelan. Berbagai pilihan media label Epson mulai dari ukuran lebar, pola, warna dan gaya untuk membuat kualitas tinggi, label profesional dengan limbah minimal dan penghematan yang maksimum.



Weather Resistant



Abrasion Resistant



Temperature Resistant



Water Resistant



Chemical Resistant

Penghematan biaya

Semua printer LabelWorks dirancang untuk efisiensi biaya yang lebih besar. Melalui penggunaan sisi signifikan margin yang lebih kecil, sehingga pemborosan berkurang. Dengan panjang pita lebih panjang yang ditawarkan Epson, hemat lebih banyak biaya operasional pencetakan.

Lead margins

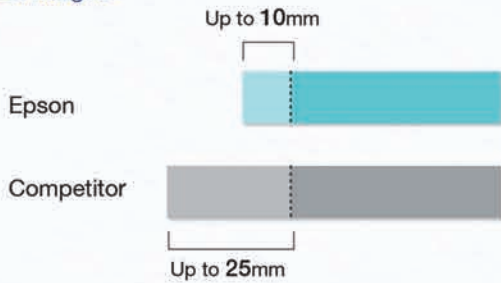

Tape savings

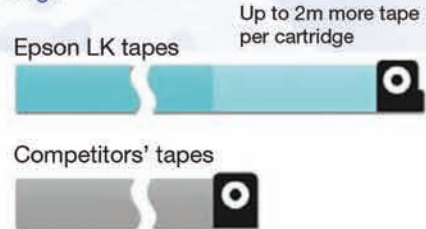

ENGINEERED FOR good

EPSON

**BE
BOLD**

**WITH VERSATILE
LABELS**

DO LABELS DIFFERENTLY

Customisable labels

From standard PET to vinyl labels type for home or office use

Extensive range

Colourful labels available in various patterns and sizes

Durability that lasts

Quality labels that weather any conditions

Intuitive, easy set-up

Print from anywhere, anytime, easy plug and play with label cartridges



LABEL PRINTER

Compact and Efficient Helper



LW-K400



Low Cost Per Print



Temperature Resistant Labels

Technology	Thermal Transfer
Print Resolution	180 dpi / 64 dot
Print Speed	Up to 6 mm/sec
Type Width	6, 9, 12, 18 mm
Display Size	130 x 48 dot
Keyboard Type	QWERTY / 61
Power Consumption	Battery 6 pcs AA (optional)
Overall Dimension	110 x 170 x 56 mm
Weight	0.41 kg

LW-700



Auto Cutter



Low Cost Per Print



Temperature Resistant Labels



Technology	Thermal Transfer
Print Resolution	180 dpi / 128 dot
Print Speed	Up to 25 mm/sec
Type Width	6, 9, 12, 18, 24 mm
Display Size	128 x 64 dot
Keyboard Type	QWERTY / 61
Operating System	Win7, Vista, XP (32/64 Bit), Mac OS
Overall Dimension	235 x 180 x 80 mm
Weight	0.77 kg

Professional Labelling

LW-C410



Auto Cutter



Low Cost Per Print



Temperature Resistant Labels



Technology	Thermal Transfer
Print Resolution	180 dpi / 96 dots
Type Width	6, 9, 12, 18 mm
Max. Print Speed	9 mm / sec
Cartridge Type	LK Tape Cartridge
Max. Print Width	13.5 mm
Interface	Bluetooth
Batteries	6 pcs AA
Dimension	54 x 134 x 145 mm
Weight	0.41 kg

LABEL PRINTER

Professional Labelling



LW-600P



Auto
Cutter



Low Cost
Per Print



Temperature
Resistant
Labels

Technology	Thermal Transfer
Print Resolution	180 dpi / 128 dot
Type Width	6, 9, 12, 18, 24 mm
Display Size	N/A
Keyboard Type	Dependent on user's PC
Operating System	Windows, Mac OS, Android & iOS
Power Consumption	Battery 6 pcs AA
Overall Dimension	55 x 132 x 146 mm
Weight	0.44 kg

LW-Z5000WA



Auto
Cutter



Low Cost
Per Print



Temperature
Resistant
Labels

Technology	Thermal Transfer
Print Resolution	180 dpi / 128 dot
Print Speed	Up to 30 mm/sec
Type Width	12 - 50 mm
Max. Print Speed	Up to 30 mm/sec
Operating System	Windows XP, Vista, 7, 8, 9, 10
Power Consumption	AC adapter
Overall Dimension	136 x 298 x 90 mm
Weight	1.11 kg

LW-Z5010BA



Auto
Cutter



Low Cost
Per Print



Temperature
Resistant
Labels

Technology	Thermal Transfer & Direct Thermal
Print Resolution	360 dpi / 384 dot
Type Width	12 - 50 mm
Display Size	4.3 inch
Keyboard Type	Dependent on user's PC
Operating System	Win7, Vista, XP (32/64 Bit), Mac OS
Interface	USB, Wi-Fi, LAN
Power Consumption	AC adapter/Battery Li-ion
Overall Dimension	123 x 153 x 139 mm
Weight	1.08 kg

LABEL PRINTER



LW-Z900FK



Auto
Cutter



Low Cost
Per Print



Temperature
Resistant
Labels

Technology	Thermal Transfer
Print Resolution	360 dpi / 384 dot
Print Speed	Up to 35 mm/sec
Type Width	6 - 36 mm
Display Size	N/A
Keyboard Type	QWERTY
Operating System	Windows XP, Vista, 7 - 10, MAC - OS
Power Consumption	Li-ion Battery (bundled) / 6AA (optional)
Overall Dimension	136 x 295 x 97 mm
Weight	1.25 kg

LW-Z700FK



Auto
Cutter



Low Cost
Per Print



Temperature
Resistant
Labels



Technology	Thermal Transfer
Print Resolution	180 dpi / 128 dot
Print Speed	Up to 30 mm/sec
Type Width	6 - 24 mm
Keyboard Size	QWERTY
Max. Print Speed	Up to 30 mm/sec
Operating System	Windows XP, Vista, 7, 8, 9, 10
Power Consumption	Li-ion Battery (Bundled) / 6AA (Optional)
Overall Dimension	136 x 298 x 90 mm
Weight	1.11 kg

LW-1000P



Auto
Cutter



Low Cost
Per Print



Temperature
Resistant
Labels



Technology	Thermal Transfer & Direct Thermal
Print Resolution	360 dpi / 384 dot
Type Width	6, 9, 12, 18, 24, 36 mm
Display Size	N/A
Keyboard Type	Dependent on user's PC
Operating System	Win7, Vista, XP (32/64 Bit), Mac OS
Interface	USB, Wi-Fi, LAN
Power Consumption	AC adapter
Overall Dimension	123 x 153 x 139 mm
Weight	1.08 kg

LABEL PRINTER

Label Printer Consumable

Remarks	Material Code	Description	Remarks	Material Code	Description
Compatible for Epson LabelWorks			Compatible for Epson LabelWorks		
Heat Shrink Tube	C53S654903	LK-4WBA3 - Black On White HT Shrink dia. 3mm	Consumable	C13S090009	Clean Stick A
	C53S654905	LK-4YBA3 - Black On Yellow HT Shrink dia. 3mm		C13S090011	Clean Stick B
	C53S654904	LK-4WBA5 - Black On White HT Shrink dia. 5mm		C13T639000	L-4033A Overprint Ink Cartridge (700ml)
	C53S654906	LK-4YBA5 - Black On Yellow HT Shrink dia.5mm		C13T639100	L-4033A Photo Black Ink Cartridge (700ml)
	C53S656902	LK-6WBA11 - Black On White HT Shrink dia. 11mm		C13T639200	L-4033A Cyan Ink Cartridge (700ml)
	C53S656904	LK-6YBA11 - Black On Yellow HT Shrink dia. 11mm		C13T639300	L-4033A Magenta Ink Cartridge (700ml)
	C53S656903	LK-6WBA14 - Black On White HT Shrink dia. 14mm		C13T639400	L-4033A Yellow Ink Cartridge (700ml)
	C53S656905	LK-6YBA14 - Black On Yellow HT Shrink dia. 14mm		C13T639500	L-4033A Mate Black Ink Cartridge (700ml)
	C53S657903	LK-7WBA21 - Black On White HT Shrink dia. 21mm		C13T639600	L-4033A Orange Ink Cartridge (700ml)
	C53S657904	LK-7YBA21 - Black On Yellow HT Shrink dia. 21mm		C13T639700	L-4033A Green Ink Cartridge (700ml)
Die-Cut	C53S658901	LK-8WBWAA - Die-Cut (Circle)	C13T639800	L-4033A Moisture Liquid Cartridge (350ml)	
	C53S658902	LK-8WBWAB - Die-Cut (Oval)	C13T639A00	Uncoated Black Cartridge for L-4033A	
	C53S658903	LK-8WBWAC - Die-Cut (Rectangle)	C13T639B00	White Cartridge for L-4033A	
6mm	C53S652501	LK-2WBN - 6mm Black On White Tape	C13T639C00	Storage liquid for L-4033A	
9mm	C53S653501	LK-3WBN - 9mm Black On White Tape	C13T639D00	Moisture Liquid (700ml) for L-4033A	
	C53S653504	LK-3GBP - 9mm Black On Green	C13S400063	Swab Head A	
	C53S653506	LK-3YBP - 9mm Black On Yellow			
12mm	C53S654501	LK-4WBN - 12mm Black On White Tape	Consumable	C13S090009	Clean Stick A
	C53S654502	LK-4WRN - 12mm Red On White Tape		C13S090011	Clean Stick B
	C53S654503	LK-4WLN - 12mm Blue On White Tape		C13S210062	Cloth for Web Cleaner
	C53S654505	LK-4BWV - 12mm White On White Tape		C13T799100	L-6034 Black Ink Cartridge (3L)
	C53S654506	LK-4SBM - 12mm Black On Silver Tape		C13T799200	L-6034 Cyan Ink Cartridge (3L)
	C53S654507	LK-4KBM - 12mm Black On Gold Tape		C13T799300	L-6034 Magenta Ink Cartridge (3L)
	C53S654508	LK-4WBQ - 12mm Black On White Iron-On		C13T799400	L-6034 Yellow Ink Cartridge (3L)
	C53S654509	LK-4PBQ - 12mm Black On Pink Iron-On		C13T799500	L-6034 D Varnish Ink Cartridge (3L)
	C53S654510	LK-4KBK - 12mm Black On Gold (Ribbon)		C13T799600	L-6034 White Ink Cartridge (2.6L)
	C53S654511	LK-4PBK - 12mm Black On Pink (Ribbon)		C13T799800	L-6034 Storage Liquid (2.6L)
	C53S654512	LK-4EAY - 12mm Gray On Polkadot Pink Tape	7112440	Washing liquid - EDGAC (20 Liter)	
	C53S654513	LK-4CAY - 12mm Gray On Blue Check Tape			
	C53S654514	LK-4TBN - 12mm Black On Transparent Tape			
	C53S654515	LK-4YBP - 12mm Black On Yellow Tape			
	C53S654518	LK-4LBP - 12mm Black On Blue			
18mm	C53S655501	LK-5WBN - 18mm Black On White Tape			
	C53S655502	LK-5WRN - 18mm Red On White Tape			
	C53S655504	LK-5SBM - 18mm Black On Silver Tape			
	C53S655507	LK-5KBM - 18mm Black On Gold Tape			
	C53S655512	LK-5TBN - 18mm Black On Transparent Tape			
	C53S655513	LK-5ZBU - 18mm Black On Glow-In-Dark Tape			
	C53S655514	LK-5YBP - 18mm Black On Yellow Tape			
	C53S655519	LK-5GBP - 18mm Black On Green			
24mm	C53S656501	LK-6WBN - 24mm Black On White Tape			
	C53S656503	LK-6BWV - 24mm White On Black Tape			
	C53S656507	LK-6YBP - 24mm Black On Yellow Tape			
	C53S656901	LK-6WBC - 24mm Black on 1/3 White 2/3 Color Tape			
36mm	C53S657501	LK-7WBN - 36mm Black On White Tape			
	C53S657503	LK-7RBP - 36mm Black On Red Tape			
	C53S657504	LK-7YBP - 36mm Black On Yellow Tape			
	C53S657506	LK-7LWV - 36mm White On Blue Tape			
	C53S657507	LK-7TBN - 36mm Black On Transparent			
	C53S657508	LK-7GBP - 36mm Black On Green			
	C53S657902	LK-7WBC - 36mm Black on 1/3 White 2/3 Color Tape			

ENGINEERED FOR good

EPSON

SOLUSI LENGKAP UNTUK KEBUTUHAN LABEL ANDA.



RUMAH



PERUSAHAAN



INDUSTRI



DISC PUBLISHER



ECO

DISC PUBLISHER

Discproducer combines Epson's market leading expertise in advanced inkjet printing and precision robotics to offer an efficient and highly reliable integrated disc publishing solution for a wide range of industries and applications. With Discproducer, fully automated Blu-Ray, DVD and CD publishing is just a push of a button away.

Unrivalled Performance with Cost Savings

Epson's industry-leading Micro Piezo print head and ink technology ensure uniform, stable ink droplets with virtually no satellites or misting, producing brilliant and crisp disc labels at a high resolution of up to 1440 dpi x 720 dpi.

Epson's Micro Piezo™ technology also protects against striation and ink bleed, and allows ultra-fine colour graduation plus razor-sharp text – even in small font sizes.

Instead of using the traditional whole cartridges, Discproducer utilises six individual high-capacity ink cartridges that can be easily replaced quickly, thus allowing you to print more while keeping running costs low.



Convenient Total Front-Operation

Discproducer is the only system in its class that offers the ergonomic advantages of total front-operation and status reporting.

Unlike other systems that allow publishing to continue without ink, Discproducer shows ink level status using an LED for each individual colour. This allows the printing process to be manually or automatically interrupted in case of a near-empty ink cartridge, thereby eliminating damage and waste.



High Precision and Reliability

Discproducer is built to withstand hard knocks and keep dust out. The solid body provides a sturdy housing for the intricate technologies within to run processes smoothly without any interruption.



Misfed and damaged discs are a thing of the past, thanks to the patented AcuGrip robotic arm which handles one disc at a time reliably. This reduces the risk of incurring scratches on the disc, often caused by conventional sliding mechanisms and prevents interruptions during unsupervised production, caused by mechanical blockage.

AcuGrip™



DISC PUBLISHER

Disc Producer Series

PP-100III



- Publishing Speed** CD: 30 discs/hour
DVD: 15 discs/hour
- Printing Only** CD: 60 discs/hour, bidirectional (fast mode)
DVD: 40 discs/hour, bidirectional (fine mode)
- Print specifications** Serial Serial inkJet Dot-Matrix, Six-color (Dye ink: C, LC, M, LM, Y, Bk) / 1,440 dpi x 720 dpi (fast mode) / 1,440 dpi x 1,440 dpi (fine mode) / 720 dpi x 720 dpi (PP-100AP Level3)
- CD/DVD Drives** 2 drives
- Supported Media** CD-R, DVD-R, DVD+R, DVD-R DL
- Interface** Hi-Speed USB
- Overall Dimensions** 377 (W) x 465 (D) x 348 (H) mm
- Mass** Approx. 24.0 kg
- Software** EPSON Total Disc Maker: Installed to the user's PC to publish discs/PP-100; EPSON Total Disc Monitor: Displays the status of jobs and devices; EPSON Printer driver for PP-100 Series; EPSON Total Disc Net Administrator: The web application for product setting, user management, job history management & authorization workflow (PP-100N only); TD Bridge: System incorporation tool to use the PP-100, PP-100N, PP-50 with other companies' applications. (Included CD does not have this software).

PP-100NII



- Publishing Speed** CD: 30 discs/hour
DVD: 15 discs/hour
- Printing Only** CD: 60 discs/hour, bidirectional (fast mode)
DVD: 40 discs/hour, bidirectional (fine mode)
- Print specifications** Serial Serial inkJet Dot-Matrix, Six-color (Dye ink: C, LC, M, LM, Y, Bk) / 1,440 dpi x 720 dpi (fast mode) / 1,440 dpi x 1,440 dpi (fine mode) / 720 dpi x 720 dpi (PP-100AP Level3)
- CD/DVD Drives** 2 drives
- Supported Media** CD-R, DVD-R, DVD+R, DVD-R DL
- Interface** Ethernet
- Overall Dimensions** 377 (W) x 514 (D) x 348 (H) mm
- Mass** Approx. 25.0 kg
- Software** EPSON Total Disc Maker: Installed to the user's PC to publish discs/PP-100; EPSON Total Disc Monitor: Displays the status of jobs and devices; EPSON Printer driver for PP-100 Series; EPSON Total Disc Net Administrator: The web application for product setting, user management, job history management & authorization workflow (PP-100N only); TD Bridge: System incorporation tool to use the PP-100, PP-100N, PP-50 with other companies' applications. (Included CD does not have this software).

DISC PUBLISHER

PP-50II



- Publishing Speed** CD: 15 discs/hour
DVD: 8 discs/hour
- Printing Only** CD: 60 discs/hour, bidirectional (fast mode)
DVD: 40 discs/hour, bidirectional (fine mode)
- Print specifications** Serial InkJet Dot-Matrix, Six-color (Dye ink: C, LC, M, LM, Y, Bk) / 1,440 dpi x 720 dpi (fast mode) / 1,440 dpi x 1,440 dpi (fine mode) / 720 dpi x 720 dpi (PP-100AP Level3)
- CD/DVD Drives Supported Media** 1 drives
CD-R, DVD-R, DVD+R, DVD-R DL, DVD+R DL
Stackers 1, 2: 50 discs (Publishes up to 50 discs in a single job)
- Stacker Capacity** Stackers 3: 20 discs
- Interface** Hi-Speed USB
- Power Consumption** Approx. 40 W (mean)
- Overall Dimensions** 377 (W) x 465 (D) x 324 (H) mm
- Mass** Approx. 21.0 kg
- Reliability** Product life: 15,000 discs or 5 years CD/DVD drive:
15,000 times (number of writing), 1,000 hours (writing time)
- Software** EPSON Total Disc Maker: Installed to the user's PC to publish discs/PP-100; EPSON Total Disc Monitor: Displays the status of jobs and devices; EPSON Printer driver for PP-100 Series; EPSON Total Disc Net Administrator: The web application for product setting, user management, job history management & authorization workflow (PP-100N only); TD Bridge: System incorporation tool to use the PP-100, PP-100N, PP-50 with other companies' applications. (Included CD does not have this software).

PP-100 CONSUMABLE

Material Code	Description
C13S020688	PP-100 I/C C
C13S020689	PP-100 I/C LC
C13S020690	PP-100 I/C LM
C13S020691	PP-100 I/C M
C13S020692	PP-100 I/C Y
C13S020693	PP-100 I/C K

DOT MATRIX PRINTER



**QUALITY
& VALUE**
GENUINE SUPPLIES



ECO

DOT MATRIX PRINTER

MENGAPA MEMILIH PRINTER DOT MATRIX EPSON?

Printer Epson dot matrix adalah partner ideal Anda untuk pencetakan tugas berat dengan biaya rendah melalui kemampuannya untuk bekerja dengan Multi-part. Printer ini hanya membutuhkan penggantian pita sesekali karena pita tinta yang digunakan tetap berfungsi bahkan setelah penyimpanan lama, berfungsi sebagai pekerja keras yang ideal untuk bisnis Anda.

ESC / P yang dikembangkan Epson adalah kontrol untuk printer dot matrix standar dunia. Ini berarti terlepas dari platform, perangkat lunak atau jaringan yang Anda gunakan, sehingga dapat langsung menyambungkan dan menjalankan printer Anda.



Quality and Value

Pita asli Epson memastikan hasil lebih besar, kualitas lebih baik, dan umur lebih panjang



Maximise Productivity

Cetak di atas kertas bersambung dan kertas belapis untuk membuat salinan karbon yang memenuhi kebutuhan spesifik bisnis Anda



Cost-efficient

Nikmati biaya kepemilikan yang rendah dengan biaya cetak yang kompetitif per halaman melalui pita tinta yang ekonomis.



Superior Reliability

dirancang untuk bertahan dengan kualitas yang kuat dan kinerja yang konsisten.



Hassle-free

Tengan pita tinta yang tahan lama dan waktu rata-rata yang tinggi di antara kegagalan (MTBF), Anda akan mendapatkan waktu henti yang minimal.

DOT MATRIX PRINTER

SIDM 9-Pin Printers



Total Nilai
TKDN + BMP
36.08%

LX-310



Print Method	Impact dot matrix
Number of Pins	9 pins
Number of Columns	80 columns (10 cpi)
Print Speed	High speed: 347 / 357 / 390 cps Draft: 260 / 312 / 223 cps NLQ: 65 / 78 / 55 / 47 / 56 cps
Reliability	Printhead life: Approx. 400 million strokes/wire MVBF: Approx. 20 million lines (Except print head) MTBF: Approx. 10,000 POH (25% Duty)
Ribbon Life	Approx. 4.0 million characters
Operating System	Microsoft® Windows® 2000 / XP / Vista / 7 / 8 / 8.1 / 10
Memory Buffer	128 KB
Interface	Bi-directional parallel (IEEE-1284 nibble mode supported), USB 2.0 Full-Speed, Serial
Power Consumption	Approx. 27W
Dimension	362 x 275 x 154 mm
Weight	Approx. 4.1 kg

FX-2190II



Print Method	Impact dot matrix
Number of Pins	9 pins
Number of Columns	136 columns (10 cpi)
Print Speed	Ultra speed: 615 / 738 cps High speed: 612 / 694 cps Draft: 463 / 555 cps
Reliability	Printhead life: 400 million strokes/wire MVBF: 52 million lines (except print head) MTBF: 25,000 Power On Hours (POH) (25% Duty)
Ribbon Life	Approx. 12 million characters
Operating System	Microsoft Windows XP / Vista / 7 / 8 / 10
Memory Buffer	128 KB
Interface	USB 2.0, Bi-directional parallel (IEEE-1284 nibble mode supported)
Power Consumption	Approx. 54W
Dimension	612 x 375 x 176.5 mm
Weight	Approx. 9.4 kg

DOT MATRIX PRINTER

SIDM 9-Pin Printers

FX-2190IIN



Print



Cost Effective



High Speed Printing



Ethernet



Print Method	Impact dot matrix
Number of Pins	9 pins
Number of Columns	136 columns (10 cpi)
Print Speed	Ultra speed: 615 / 738 cps High speed: 612 / 694 cps Draft: 463 / 555 cps
Reliability	Printhead life: 400 million strokes/wire MVBF: 52 million lines (except print head) MTBF: 25,000 Power On Hours (POH) (25% Duty)
Ribbon Life	Approx. 12 million characters
Operating System	Microsoft Windows XP / Vista / 7 / 8 / 10
Memory Buffer Interface	128 KB USB 2.0, Bi-directional parallel (IEEE-1284 nibble mode supported) Serial, 100base-TX wired LAN
Power Consumption	Approx. 54W
Dimension	612 x 375 x 176.5 mm
Weight	Approx. 9.4 kg

DFX-9000



Print



Cost Effective



High Speed Printing



Print Method	Impact dot matrix
Number of Pins	36 pins
Number of Columns	136 columns (10 cpi)
Print Speed	High speed: 1,550 / 1,450 cps Draft: 1.320 x 1.320 cps NLQ: 330 / 330 cps
Reliability	Printhead life: 200 million strokes/wire MVBF: 133 million lines (except print head) MTBF: 20,000 POH (25% duty cycle)
Ribbon Life	15 million characters
Operating System	Microsoft Windows® Me / XP / Vista® / Windows 7 / 8 / 8.1 / 10 (32/64bit)
Memory Buffer Interface	128 KB Bi-directional parallel interface (IEEE-1284 nibble mode supported), Serial I/F, USB 2.0 (Full Speed) I/F
Power Consumption	Approx. 185W
Dimension	700 x 378 x 363 mm
Weight	Approx. 34 kg

DOT MATRIX PRINTER

SIDM 24-Pin Printers



Total Nilai
TKDN + BMP
36.29%

LQ-310



Print



Cost Effective



High Speed Printing

Print Method	Impact dot matrix
Number of Pins	24 pins
Number of Columns	80 columns (10 cpi)
Print Speed	High speed: 347 / 416 cps Draft: 260 / 312 / 390 cps NLQ: 86 / 103 / 129 cps
Reliability	Printhead life: Approx. 400 million strokes/wire MVBf: Approx. 20 million lines (except print head) MTBF: Approx. 10,000 POH (25% Duty)
Ribbon Life	Approx. 2.5 million characters
Operating System	Windows 95 / 98 / 2000 / Me / XP / Vista / 7 / 8 / 8.1 / 10
Memory Buffer Interface	128 KB Bi-directional parallel interface (IEEE-1284 nibble mode supported), USB 2.0 Full-Speed, Serial
Power Consumption	Approx. 24W
Dimension	362 x 275 x 154 mm
Weight	Approx. 4.1 kg

LQ-590II



Print



Cost Effective



High Speed Printing



Print Method	Impact dot matrix
Number of Pins	24 pins
Number of Columns	80 columns (10 cpi)
Print Speed	Ultra high speed: 550 cps High speed: 487 / 584 cps Draft: 366 / 439 cps
Reliability	Printhead life: 400 million strokes / wire MVBf: 50 million lines (except print head) MTBF: 25,000 Power On Hours (POH) (25% Duty)
Ribbon Life	Approx. 5 million characters
Operating System	Microsoft Windows XP / Vista / 7 / 8 / 10
Memory Buffer Interface	128 KB USB 2.0, Bi-directional parallel, (IEEE-1284 nibble mode supported)
Power Consumption	Approx. 49W
Dimension	414 x 320 x 176.5 mm
Weight	Approx. 7.2 kg

DOT MATRIX PRINTER

SIDM 24-Pin Printers

LQ-590IIN



Print Method	Impact dot matrix
Number of Pins	24 pins
Number of Columns	80 columns (10 cpi)
Print Speed	Ultra high speed: 550 cps High speed: 487 / 584 cps Draft: 366 / 439 cps
Reliability	Printhead life: 400 million strokes / wire MVBF: 50 million lines (except print head) MTBF: 25,000 Power On Hours (POH) (25% Duty)
Ribbon Life	Approx. 5 million characters
Operating System	Microsoft Windows XP / Vista / 7 / 8 / 10
Memory Buffer	128 KB
Interface	USB 2.0, Bi-directional parallel (IEEE-1284 nibble mode supported), Serial, 100base-Tx wired LAN
Power Consumption	Approx. 49W
Dimension	414 x 320 x 176.5 mm
Weight	Approx. 7.2 kg

LQ-2090II



Print Method	Impact dot matrix
Number of Pins	24 pins
Number of Columns	136 columns (10 cpi)
Print Speed	Ultra speed: 550 cps High speed: 487 / 584 cps Draft: 366 / 439 cps
Reliability	Printhead life: 400 million stroke/wire MVBF: 50 million lines (except print head) MTBF: 25,000 Power On Hours (POH) (25% Duty)
Ribbon Life	Approx. 8 million characters
Operating System	Microsoft Windows XP / Vista / 7 / 8 / 10
Memory Buffer	128 KB
Interface	USB 2.0, Bi-directional parallel (IEEE-1284 nibble mode supported)
Power Consumption	Approx. 49W
Dimension	612 x 375 x 176.5 mm
Weight	Approx. 9.4 kg

DOT MATRIX PRINTER

SIDM 24-Pin Printers



LQ-780



Print



Cost Effective



High Speed Printing

Print Method	Impact dot matrix
Number of Pins	24 pins
Number of Columns	136 columns (10 cpi)
Print Speed	High speed: 487 / 584 cps Draft: 366 / 439 / 549 cps LQ: 121 / 145 / 181 cps
Reliability	Printhead life: 400 million strokes/wire MVBF: 40 million lines (Except print head) MTBF: 20,000Hrs POH (25% duty cycle)
Ribbon Life	Approx. 10 million characters
Operating System	Microsoft Windows XP / Vista / 7 / 8 / 8.1 / 10 / 11
Memory Buffer	128 KB
Interface	Bi-directional Parallel (IEEE 1284 Nibble mode support), USB 2.0 (Full Speed Mode)
Power Consumption	Approx. 46W
Dimension	480 x 301.3 x 211 mm
Weight	Approx. 6.7 kg



LQ-780N



Print



Cost Effective



High Speed Printing



Ethernet

Print Method	Impact dot matrix
Number of Pins	24 pins
Number of Columns	106 columns (10 cpi)
Print Speed	High speed: 487 / 584 cps Draft: 366 / 439 / 549 cps LQ: 121 / 145 / 181 cps
Reliability	Printhead life: 400 million strokes/wire MVBF: 40 million lines (Except print head) MTBF: 20,000Hrs POH (25% duty cycle)
Ribbon Life	Approx. 10 million characters
Operating System	Microsoft Windows XP / Vista / 7 / 8 / 8.1 / 10 / 11
Memory Buffer	128 KB
Interface	Bi-directional Parallel (IEEE 1284 Nibble mode support), USB 2.0 (Full Speed Mode), LAN (for N models only)
Power Consumption	Approx. 46W
Dimension	480 x 301.3 x 211 mm
Weight	Approx. 6.7 kg

DOT MATRIX PRINTER

SIDM 24-Pin Printers

LQ-2090IIN



Print Method	Impact dot matrix
Number of Pins	24 pins
Number of Columns	136 columns (10 cpi)
Print Speed	Ultra high speed: 550 cps High speed: 487 / 584 cps Draft: 366 / 439 cps
Reliability	Printhead life: 400 million strokes / wire MVBF: 50 million lines (except print head) MTBF: 25,000 Power On Hours (POH) (25% Duty)
Ribbon Life	Approx. 8 million characters
Operating System	Microsoft Windows XP / Vista / 7 / 8 / 10
Memory Buffer	128 KB
Interface	USB 2.0, Bi-directional parallel (IEEE-1284 nibble mode supported), Serial, 100base-Tx wired LAN
Power Consumption	Operating Approx. 49W/Sleep Mode Approx. 0.8W
Dimension	612 x 375 x 176.5mm
Weight	9.4kg

LQ-2190



Print Method	Impact dot matrix
Number of Pins	24 pins
Number of Columns	136 columns (10 cpi)
Print Speed	High speed: 480 / 576 cps Draft: 360 / 432 / 540 cps NLQ: 120 / 144 / 180 cps
Reliability	Printhead life: Approx. 400 million strokes/wire MVBF: Approx. 40 million lines (except print head) MTBF: 20,000 Power On Hours (POH) (25% Duty)
Ribbon Life	Approx. 15 million characters
Operating System	Microsoft® Windows® 2000 / XP / Vista / 7 / 8 / 8.1 / 10
Memory Buffer	128 KB
Interface	Bi-directional Parallel Interface (IEEE-1284 nibble mode supported), USB 2.0 (Full Speed), Type B I/F Level 2 (Option)
Power Consumption	Approx. 46W
Dimension	639 x 402 x 256 mm
Weight	Approx. 13 kg



Total Nilai TKDN + BMP
37.84%

DOT MATRIX PRINTER

SIDM 48-Pin Printers

DLQ-3500IIN STD



Print



Cost Effective



High Speed Printing



Ethernet



Print Method	Impact dot matrix
Number of Pins	24 pins x 2 (total 48 pins)
Number of Columns	136 columns (10 cpi)
Print Speed	High speed: 550 cps Draft: 550 cps LQ: 195 cps
Reliability	MVBF: 25 million lines MTBF: 10,000 Power On Hours (POH) Printhead life: 200 million strokes / wire
Ribbon Life	Approx. 6 million characters
Operating System	Microsoft Windows® XP / Vista / 7 / 8 / 10
Memory Buffer	128 KB
Interface	USB 2.0, Bi-directional parallel (IEEE-1284 nibble mode supported), 100base-Tx wired LAN
Power Consumption	Approx. 78 W
Dimension	661 x 433 x 276 mm
Weight	18.9 kg



Superior Reliability

Engineered to last with sturdy build quality and deliver consistent performance.

Maximise Productivity

Prints on continuous paper as well as multi-part stationery to make carbon copies to meet your business-specific needs.



Cost-efficient

Enjoy low cost of ownership with competitive print cost per page through economical ink ribbons.



Hassle-free

With lasting ink ribbons and high mean time between failures (MTBF), you can expect minimal downtime.





DO COMPATIBLE RIBBONS SAVE YOU MONEY?



We commissioned Buyers Lab to test out how compatible ribbons fare against Epson genuine ribbons, and the results prove you can expect smoother workflows and greater productivity with our quality ribbons.

EPSON GENUINE RIBBONS

VS

COMPATIBLE RIBBONS

100% RELIABLE
FOR PEACE OF MIND

no printer breakdowns or printing problems with Epson genuine ribbons



No failed cartridges in testing, which would

SAVE YOU TIME & MONEY

Up to

65% HIGHER
character yields!



Good Printout Quality

GOOD & CONSISTENT PRINTOUT QUALITY

Epson genuine ribbons ensure that you get high quality and long-lasting printouts

COMPATIBLE RIBBONS

FAILED 75%

of the time they were used, resulting in printer breakdowns that would have disrupted business

57% of compatible ribbons had at least one cartridge failure that resulted in an average of

5 DAYS DOWNTIME*

for service call



LOWER

character yields and overall performance

Poor Printout Quality

POOR PRINTOUT QUALITY
that could fade away easily

*Data from Epson Singapore Customer Service Centre

DOT MATRIX PRINTER

Passbook Printers



Total Nilai
TKDN + BMP
33.08%

PLQ-35



Print



Cost Effective



High Speed Printing

Print Method	Impact Dot Matrix
Number of Pins	24 pins
Number of Columns	94 columns (10 cpi)
Print Speed	Ultra High Speed 540 cps High Speed 480 cps Draft 360 cps
Reliability	Printhead Life 400 million strokes / wire MVBF 21 million lines MTBF 30000 POH
Ribbon Life	Approx. 5 million characters
Operating System	Microsoft Windows XP, Vista, 7, 8, 8.1, 10, Windows Server 2003, 2008, 2012, 2016
Interface	Bi-directional parallel interface (IEEE-1284 nibble mode supported), Serial I/F, High Speed USB 2.0
Power Consumption	61W Operational / 0.7 W Sleep Mode
Dimension	384 x 280 x 203 mm
Weight	7.8 kg

PLQ-50



Print



High Speed Printing



Colour LED Control Panel



Cost Effective



Power Savings



Total Nilai
TKDN + BMP
32.55%

Print Method	Impact Dot Matrix
Number of Pins	24 pins
Number of Columns	94 columns (10 cpi)
Print Speed	Ultra High Speed 630 cps High Speed 560 cps Draft 420 cps
Reliability	Printhead Life 600 million strokes / wire MVBF 24 million lines MTBF 35000 POH
Ribbon Life	Approx. 5 million characters
Operating System	Microsoft Windows XP, Vista, 7, 8, 8.1, 10, Windows Server 2003, 2008, 2012, 2016
Interface	Bi-directional parallel interface (IEEE-1284 nibble mode supported), Serial I/F, High Speed USB 2.0
Power Consumption	77W Operational / 0.8 W Sleep Mode
Dimension	384 x 280 x 203 mm
Weight	7.9 kg

DOT MATRIX PRINTER

Dot Matrix Consumable

Product Code	Ribbon Cartridges	Main Unit	Ribbon Specifications
C13S015516	Ribbon, #8750(B), Asia	LX-300 / 300+ / 300+II	3 mil character / 17.7m, 58 ft x 13mm, 0.5"
C13S015506	Ribbon, #7753(B), Asia	LQ-300 / 300+II / 580 / LQ-200	2 mil character / 10m, 32.8 ft x 13mm, 0.5"
C13S015632	Ribbon Cartridge (S015632)	LX-310	4 mil character / 18.0m, 59 ft x 13mm, 0.5"
C13S015639	Ribbon Cartridge (S015634)	LQ-310	2.5 mil character / 10m, 32.8 ft x 13mm, 0.5"
C13S015531	Ribbon, S015086(B), Asia	LQ-2070 / 2180 / 2080 / 2190 FX-2180	3 mil character / 17.79 pin - 8 mil character / 60m, 196.8 ft x 13mm, 0.5" 24 pin - 12 mil character / 70m x 13mm, 0.5" 58 ft x 13mm, 0.5"
C13S015520	Ribbon, #8755(B), Asia	LX-1050 / 1170 / 1170 II FX-1170	3 mil character / 17.7m, 58 ft x 13mm, 0.5"
C13S015511	Ribbon, #7754(B), Asia	LQ-1150 / 1150 II	2 mil character / 12.4m, 40.6 ft x 13mm, 0.5"
C13S015589	Ribbon, S015337(B), Asia	LQ-590	5 mil character / 17m, 55.7 ft x 13mm, 0.5"
C13S015584	Ribbon, S015327(B), Asia	FX-2190 / FX-2175	8 mil character / 32m, 104.9 ft x 13mm, 0.5"
C13S015586	Ribbon, S015336(B), Asia	LQ-2090	8 mil character / 32m, 104.9 ft x 13mm, 0.5"
C13S015577	Ribbon, #8766(B), Asia	DFX-5000 / 5000+ / 8000 / 8500	15 mil character / 69.6m, 227.9 ft x 13mm, 0.5"
C13S015658	Ribbon, S015630(B), Asia	LQ-780/780N	10 mil character / 32.0m, 104.9ft x 13mm, 0.5"
C13S015508	Ribbon, S015016(B), Asia	LQ-670 / 680 / 680 Pro	2 mil character / 10m, 32.8 ft x 13mm, 0.5"
C13S015582	Ribbon, S015290(B), Asia	LQ-630	2 mil character / 8m, 26.2 ft x 13mm, 0.5"
C13S015587	Ribbon, S015066(B), STD	DLQ-3000 / 3000+ / 3500	6 mil character / 16.75m, 54.9 ft x 25.5mm, 1.0"
C13S015505	Ribbon, S015384(B), STD	DFX-9000	15 mil character / 70m, 229.6 ft x 13mm, 0.5"
C13S015585	Ribbon, S015329(B), Asia	FX-890 / FX-875	7.5 mil character / 17.0m:55.7ft, 13mm, 0.5"
C13S015592	Ribbon, S015339 (B), ESP, 3PCS	PLQ-20 / M / D / DM PLQ-35/PLQ-50	5 mil character / 36m, 118 ft x 6.5mm, 0.25"
C13S010074	Fabric Ribbon Pack Refill for S015086	LQ2070 / 2180 / 2080 / 2190 FX-2180	9 pin - 8 mil character / 60m, 196.8 ft x 13mm, 0.5" 24 pin - 12 mil character / 60m x 13mm, 0.5"
C13S010066	Fabric Ribbon Pack Refill for #7753 & #7754	LQ300 / 300+II / 580 and LQ1150 / 1150 II	2 mil character / 12.4m, 40.6 ft x 13mm, 0.5"
C13S010068	Fabric Ribbon Pack Refill for #8750 & #8755	LX300 / 300+ / 300+II and LX1050 / 1170 / 1170 II, FX1170	3 mil character / 17.7m, 58 ft x 13mm, 0.5"

ROBOT SOLUTION



Epson Robot

A proven reputation for precision and reliability at the leading edge of industrial robot design

Ever since we developed our first SCARA robots for wristwatch assembly over 40 years ago, Epson has been a leader in advanced robotics technology. Today, our long experience in energy-efficient, compact, high-precision technologies enables us to offer a wide range of slim, compact, and lightweight robots. And with the addition of original Epson force sensing and image processing technologies, we are achieving even higher levels of reliability, speed, precision, and productivity in process automation. Whatever challenges you face, Epson industrial robots are continuously evolving to meet the diversifying needs of manufacturers worldwide.

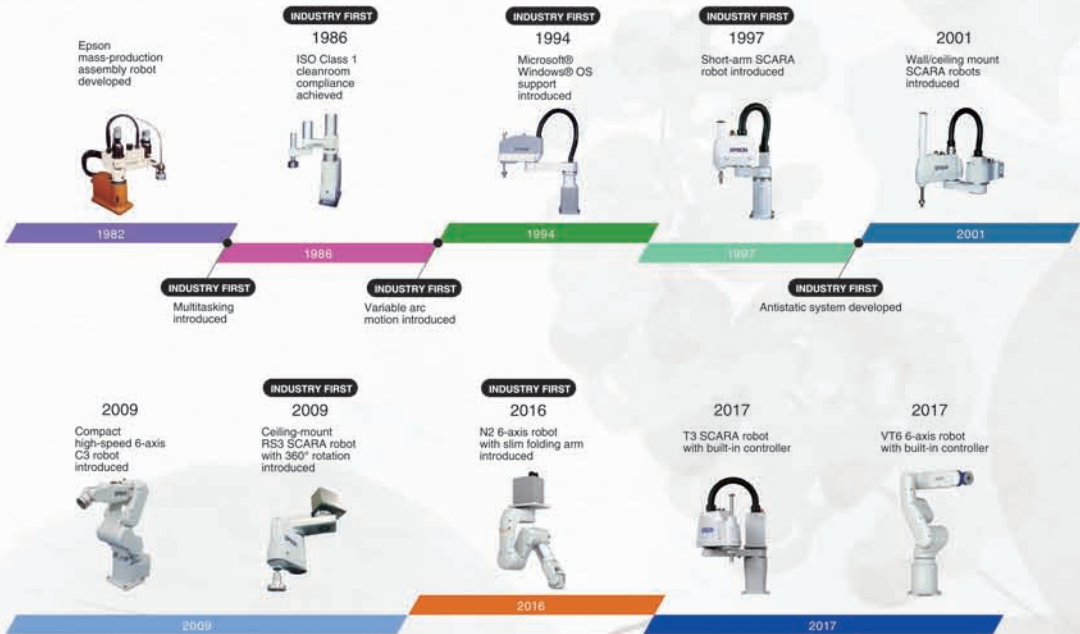

Why Epson Robots ?

Epson, the global leader in robotics technology, offers you an impressive combination of high performance and operating ease. Backed by a worldwide reputation for reliability and outstanding customer support, Epson robots are bringing high-productivity automated manufacturing to an ever-expanding range of industries worldwide.



Low TCO and high reliability for the ultimate in automated productivity

High productivity

- Proprietary Epson technology reduces residual vibration to ensure high speed and precision for reduced takt time.
- Slim, lightweight body design reduces work cell space requirements while enabling higher productivity.

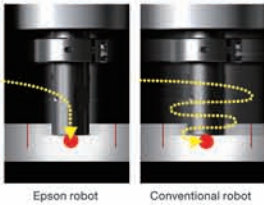

Epson robot

Conventional robot

High quality

- Extremely accurate toolhead positioning enables high-precision dispensing and cutting operations.

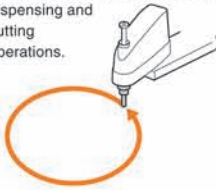

- Integrated machine vision systems boost setup ease and workpiece handling accuracy.

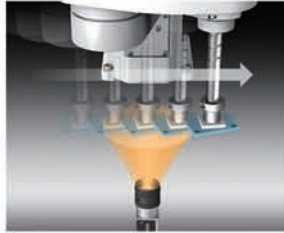

Easy operation

- Intuitive graphical interface makes programming easy even for first-time users.
- From program testing to full production, improved operating ease helps reduce cost and manpower requirements.



3D simulator for work cell layout and toolpath program testing

Software Integration



Global support

Epson supports robotics customers worldwide through an international network of sales and service offices, providing information about equipment configuration options and performing simulations of the tasks that customers want robots to perform. We are also partnered with systems integrators around the world, and can provide end-to-end turnkey solutions to meet virtually any process automation need.

ROBOT SOLUTION

Product lineup

	SCARA robots						
Epson Robot	G Series						
	Top-class speed, repeatability, and low residual vibration						
Publication page	▶P.9	▶P.11	▶P.15	▶P.17	▶P.21	▶P.23	▶P.23
Model name	G1	G3	NEW GX4	G6	NEW GX8	G10	G20
Payload (kg)	4-axis 3-axis 	Max 	Max 	Max 	Max 	Max 	Max 
Arm length (mm)							
Environmental specifications							
Installation specifications							
Compatible controller	RC700-A	RC700-A	RC700-D	RC700-A	RC700-D	RC700-A	RC700-A

ROBOT SOLUTION

SCARA robots							
LS Series				T Series		RS Series	
Proven reliability and functionality				Built-in controller for cost-efficient automation		Original space-saving design for high productivity	
▶ P.27	▶ P.29	▶ P.31	▶ P.33	▶ P.35	▶ P.37	▶ P.39	▶ P.41
LS3-B	LS6-B	LS10-B	LS20-B	NEW T3-B	NEW T6-B	RS3	RS4
Max 3	Max 6	Max 10	Max 20	Max 3	Max 6	Max 3	Max 4
400	500 600 700	600 700 800	800 1000	400	600	350	550
STD Class 4	STD Class 4	STD Class 4	STD Class 4	STD*2	STD*2	STD Class 3	STD Class 3
RC90-B	RC90-B	RC90-B	RC90-B	Built-in controller	Built-in controller	RC700-A	RC700-A



























- Standard
- Cleanroom model ISO 03 (Class 10 equiv.) ESD suppression
- Cleanroom model ISO 04 (Class 100 equiv.)
- Cleanroom model ISO 05 (Class 100 equiv.)
- Protection model IP54
- Protection model IP65
- Protection model IP67
- Table Top mount
- Wall mount
- Ceiling mount
- Wall/ceiling multi-layout mount

*1: See product page for details
*2: IP20 *3: Standard model only

































- Controllers**
- Controllers ▶ P.59
- Software**
- Software ▶ P.62
- Vision systems**
- Vision systems ▶ P.67
- Force-sensing systems**
- Force-sensing systems ▶ P.70
- Options**
- Software options ▶ P.74
- Robot controller options ▶ P.79
- Manipulator options ▶ P.79
- Option quick-reference table ▶ P.80
- Option setup example ▶ P.81



ROBOT SOLUTION

Product lineup

	<h3>6-axis robots</h3>		
	<h3>C Series</h3> <p>Slim, lightweight body for greater installation flexibility</p>		
Publication page	▶ P.43	▶ P.45	▶ P.49
Model name			
Payload (kg)	Max 	Max 	Max 
Arm length (mm)	 	  	
Environmental specifications		  	
Installation specifications	 	  	
Compatible controller			

ROBOT SOLUTION

6-axis robots			
N Series			VT
Original compact design for greater freedom of movement in tight quarters			Compact, easy setup, low TCO
▶ P.51	▶ P.53	▶ P.55	▶ P.57
N2	N6-A850	N6-A1000	VT6L
			
Max  2.5	Max  6	Max  6	Max  6
 450	 850	 1000	 900
	 	 	  
 		 	 ^{*3}  ^{*3}  
 RC700-A	 RC700-A	 RC700-A	 Built-in controller

-  Standard
-  Cleanroom model ISO 03 (Class 10 equiv.) ESD suppression
-  Cleanroom model ISO 04 (Class 100 equiv.)
-  Cleanroom model ISO 05 (Class 100 equiv.)
-  Protection model IP54
-  Protection model IP65
-  Protection model IP67

-  Table Top mount
-  Wall mount
-  Ceiling mount
-  Wall/ceiling multi-layout mount

*1: See product page for details
*2: IP20 *3: Standard model only

- Controllers**
-  Controllers ▶ P.59
- Software**
-  Software ▶ P.62
- Vision systems**
-  Vision systems ▶ P.67
- Force-sensing systems**
-  Force-sensing systems ▶ P.70
- Options**
-  Software options ▶ P.74
-  Robot controller options ▶ P.76
-  Manipulator options ▶ P.79
-  Option quick-reference table ▶ P.80
-  Option setup example ▶ P.81

Vision systems

02 Vision Guide

Get advanced machine vision and image processing systems up and running fast with easy-to-use Epson Vision Guide software

- Built-in image processing engine assists vision-to-robot calibration, making it easy to align the robot's coordinate system with the camera's field of view.
- Workpiece position can be determined relative to robot coordinates without complex calculations.
- Image processing sequences can be created simply by entering a few parameters and pointing and clicking with a mouse.
- Advanced pattern matching and geometric search tools enable easy solution program development without writing a single line of code.

System configuration examples

CV-2A(HA, SA), L

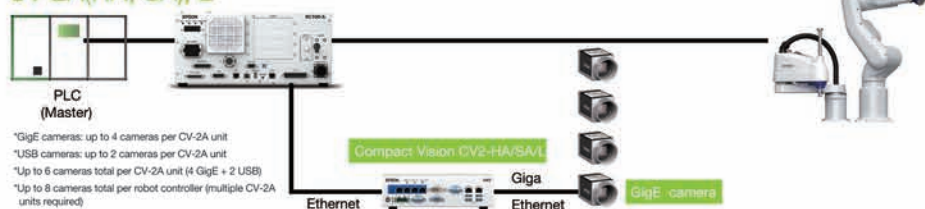

PVI

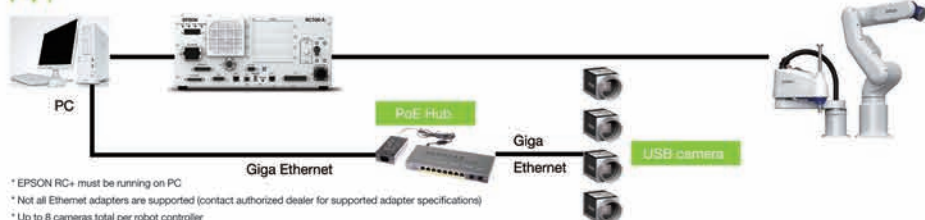

Features

Convenience

EPSON RC+ software can be used for both robot and machine vision program development.

- Other machine vision systems are more complicated to set up because different software must be used for machine vision and robot program development.

Ease of use

Easy registration of vision objects (positioning coordinates, etc.) enables rapid system setup and deployment.

- Vision objects can be registered via simple drag & drop operation.
- Intuitive interface makes operation easy even for first-time users.

● Robot & Vision Programming

- Vision & Guide Window
- Simulator
- Jog & Teach Window

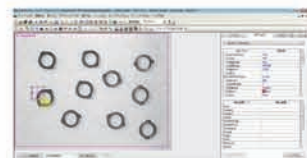

Vision simulation

Epson Vision software includes a simulator that lets you visualize robot operation and workflow before equipment is actually installed. This makes it easy to plan and configure the system for maximum productivity, and allow program development to proceed while the system is being constructed.

- Vision and process sequencing can be prepared in advance, before system is installed.
- Programs that include image processing sequences can be tested off line.
- If workpiece images are available, image processing can be tested off line.

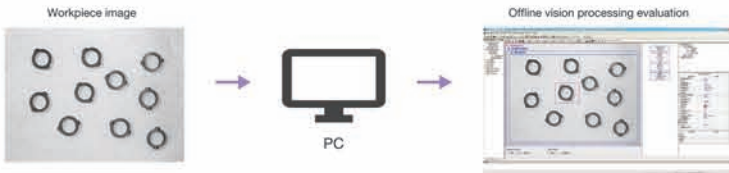

Easy calibration

A built-in image processing engine makes it easy to align the camera's field of view with the robot's coordinate system, eliminating the need for complex programming when performing vision-to-robot calibration.

The robot automatically*1 follows the steps in the Calibration Wizard to complete the calibration.*2

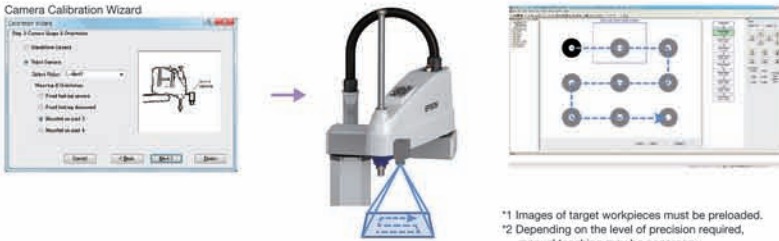

*1 Images of target workpieces must be preloaded.
*2 Depending on the level of precision required, manual teaching may be necessary.

One-stop service

Whether you need help with initial setup or active production lines, Epson gives you one-stop service convenience for both robot and machine vision systems. With only one service call instead of two to coordinate, your production line will be back up and running in no time.

Force-sensing systems

High-rigidity, high-sensitivity S250 Series force sensors are specifically designed for use with Epson robots, enabling extremely precise force control for high-precision assembly tasks.

03 Force sensors

S250 Series force sensors incorporate exclusive Epson crystal piezoelectric technology that ensures a higher level of rigidity and sensitivity than conventional force sensors.

Advantage 1 high rigidity

S250 Series sensors are extremely rigid and resistant to deformation under heavy loads. They have a rated load of 250[N] on the X, Y, and Z axes, and a moment of force of 18[Nm] that makes them particularly sensitive to axial stress.

Advantage 2 high sensitivity

S250 Series sensors also ensure excellent sensitivity and quick response with high resolution of 0.1[N] and a low noise level of 0.035[N] on the X, Y, and Z axes.

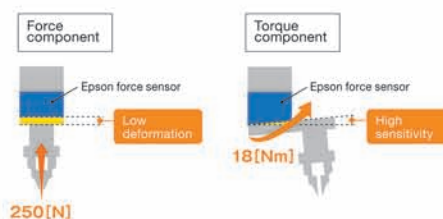

Force-sensing system applications

Robots equipped with an Epson S250 Series force sensing system can handle high-precision tasks that cannot be safely automated with teaching or machine vision systems alone. As a result, even production processes that previously required experienced workers to handle delicate and easily damaged workpieces can be fully automated.

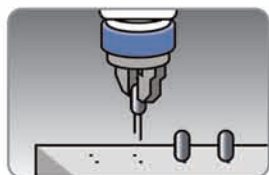

Delicate component assembly

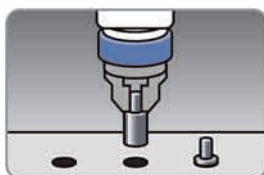

Precision mating

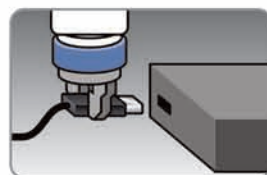

Connector insertion



Precision screw assembly



Fine polishing

One-stop Epson support

From initial planning and procurement, to setup, adjustment, ongoing maintenance and re-pair, Epson provides one-stop support for all your force-sensing system and automation needs.



High-rigidity, high-sensitivity S250 Series force sensors are specifically designed for use with Epson robots, enabling extremely precise force control for high-precision assembly tasks.

Easy force sensing program development

The new Force Guide interface makes it easy to develop force sensor operating programs simply by dragging Force Guide object icons into a flow chart. In addition, simulator motion display and force waveform monitoring make debugging easier than ever before.



Force Guide GUI

The Force Guide interface provides a clear explanation of what each programming object does, as well as a flow chart view for easy confirmation of program sequence ordering.



Simulator

The simulator enables quick confirmation of the direction of robot arm movement and axis coordinates.

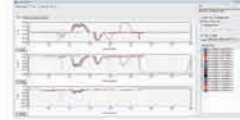

Force waveform display & recording

The force waveform display allows realtime waveforms to be compared with previously recorded waveforms, enabling users to identify operating anomalies and understand how various conditions affect performance.

Direct teaching function

6-axis robots equipped with force sensors can be taught using the Epson TP2/TP3 teaching pendant. Operators can manually move the robot arm and manipulator to the desired position and use the teaching pendant to confirm hardness/softness of the workpiece and the force to be applied.*

Touch-jog function*

In addition to the standard button-operated jog and teaching modes, the TP2 teaching pendant now has a direct teaching mode with a touch-jog function that makes 6-axis robot teaching much easier. During direct teaching operations, you can simply tap the effector to make small, incremental adjustments to the effector's position. There's no need to manually switch input modes because the system can automatically recognize the amount of force being applied to the effector.



* Supported by TP2 teaching pendant and C4, C8, N2, and N6 robots (controller firmware v7.4.6 or newer required)

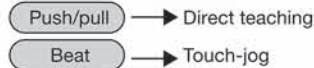

Product photos

03 S250 Series force sensor



03 FS2 communication module



FS2 system requirements

Supported controller	RC700-A One FS2 module per controller (inserted in option slot)
No. of supported force sensors	One sensor per module
Power supply	Via option slot

System setup examples

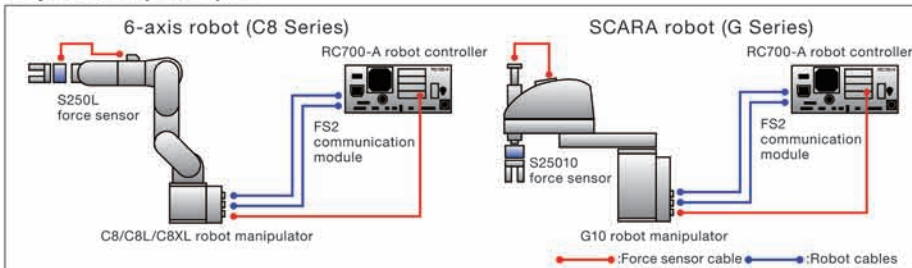

Robot controller options

A wide range of controller options are offered to expand the range of tasks and processes that can be automated.

04 Teaching Pendant (TP3)

Compatible controllers
RC200-A T series VT series

Tablet-type teaching pendant with 10.1-inch color touchscreen for intuitive operation and fast, easy 6-axis robot teaching

Easy-to-view screen

- 10.1-inch TFT LCD (w/ LED backlight)
- 1280 x 800 resolution
- Color display



Easy operation

- Simple screen layout, fast response
- Standard RC+ program interface

Advanced features

- 3D robot graphics, programming functions and parameter settings
- High-speed test mode
- Programs can be started/stopped from operating panel

Main specifications

Dimensions (mm)	314(W) x 244(H) x 142(D)
Weight	1.5kg (excluding cable)
Body color	Black
Connectivity	Wired
Display	10.1-inch TFT LCD (w/ LED backlight) Resolution: 1280 x 800
Controls	Touchscreen controls Emergency stop button Enable switch Mode switch Control keys (JOG, EXE buttons) USB port
Cable length	5m (10m, 15m extension cables available)
Interface languages	English, Japanese, German, French, Chinese (simplified, traditional)
Ingress protection	IP65
Operating temperature range	0–42°C (stable temperature)
Operating humidity range	5–95% (relative humidity)
Operating environment	Low levels of dust, oil mist, salt, iron particles and other contaminants No flammable or caustic liquids or gases nearby

External dimensions

[Unit: mm]

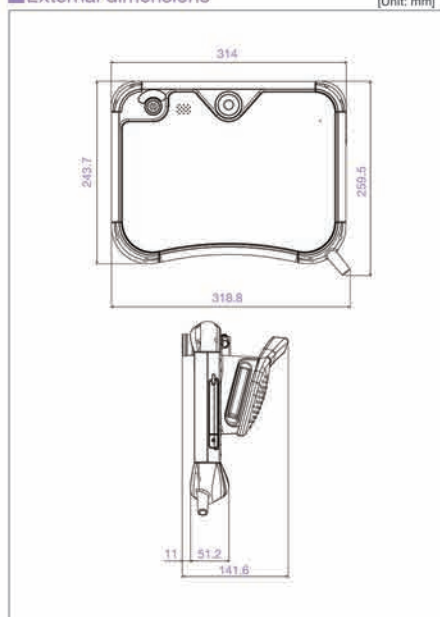

04 Teaching Pendant (TP2)

Compatible controllers
RC700-A RC90-B T series VT series

Easy-to-use pendant for teaching

- Universal design ensures ease of use for both right-handed and left-handed operators.
- Connects directly to operator unit or controller interface card.



05 Conveyor tracking

Compatible controllers
RC700-A RC90-B T series VT series

Precision tracking for high-productivity pick-and-place operation

- Enables pick-and-place handling of items on a high-speed conveyor.
- Uses machine vision/sensors to detect workpiece and effect robot handling.
- Can automate manual kitting/packaging tasks and help maintain productivity regardless of continuous/intermittent conveyor operation. Can also be used for workpiece assembly.
- Simple start/stop program execution.

*Vision Guide software required.

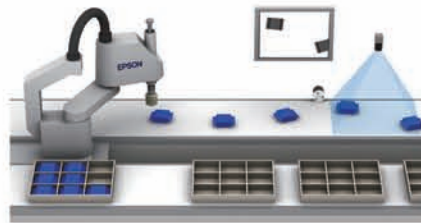

05 PG motion system

Compatible controllers
RC700-A RC90-B T series VT series

Control peripheral robots for fully integrated process automation

- EPSON RC+ software and pulse generator (PG) cards enable control of multiple third-party drives and motors.
- PG robots and standard EPSON RC+ system robots can be operated simultaneously, and controlled using the same commands.
- PG cards can be used to control X/Y tables, sliders, turrets,

and a wide range of other production/inspection line peripherals.

- Each PG card has 4 channels, and can support from 1 to 4 robots. Up to 4 cards can be mounted.

*PG motion system requires optional EPSON RC+ software and at least one optional PG output board. Drivers and motors for third-party devices are not included.

Robot controller options

06 Emergency stop switch

Compatible controllers
RC100-A RC90-B T series VT series

Helps prevent injuries and damage

- Immediately stops robot operation in emergency situations.



07 RS-232C cards

Compatible controllers
RC100-A RC90-B T series VT series

Expanded serial port connectivity

- 2-port RS-232C cards to connect serial interface devices.



08 I/O expansion cards

Compatible controllers
RC100-A RC90-B T series VT series

Expanded input/output flexibility

- 24-input/16-output expansion cards.



09 Fieldbus I/O (slave)

Compatible controllers
RC100-A RC90-B T series VT series

High-speed peripheral connectivity

- 2048-point I/O support for DeviceNet™, Ethernet/IP™, PROFIBUS®, and PROFINET® networked peripherals, and 384-point I/O support for CC-Link® networked peripherals.

10 Fieldbus I/O (master)

Compatible controllers
RC100-A RC90-B T series VT series

Bidirectional high-speed peripheral connectivity

- Support for DeviceNet™, PROFIBUS®, and Ethernet/IP™ networked peripherals (1024-point I/O).

11 Analog I/O card

Compatible controllers
RC100-A RC90-B T series VT series

For analog control of voltage and current I/O

- Analog control of input and output current and voltage allows regulation of secondary equipment such as paint sprayers to match the speed of robot arm motion. Available in 1 channel and 4 channel models.



12 EUROMAP 67 card

Compatible controllers
RC100-A RC90-B T series VT series

For use with thermoplastic injection molding machines

- EUROMAP 67 compliant electrical interface with 15-point input and 16-point output.



13 I/O cable kit

Compatible controllers
RC100-A RC90-B T series VT series

Cables and connectors for easy connectivity with no soldering required

- A wide range of I/O cables and connectors are available.



14 Hot plug kit

Compatible controllers
RC100-A RC90-B T series VT series

Easy Teach Pendant connection/disconnection

- Allows Teach Pendant to be connected or disconnected without an emergency stop.

*Conversion cable required for use with TP1 or TP2.



15 Wall mount option

Compatible controllers
RC100-A RC90-B T series VT series

Optional wall mounting box

- Allows controller to be mounted on a wall.



ROBOT SOLUTION

Manipulator options

Epson robot manipulator options provide the enhanced functionality and configuration flexibility you need for full-process automation.

16 External wiring units

Compatible manipulators

GT TR GR GE GI0 GI20 GI25 GI30 GI35 GI40 GI45 GI50 GI55 GI60 GI65 GI70 GI75 GI80 GI85 GI90 GI95 GI100 GI105 GI110 GI115 GI120 GI125 GI130 GI135 GI140 GI145 GI150 GI155 GI160 GI165 GI170 GI175 GI180 GI185 GI190 GI195 GI200 GI205 GI210 GI215 GI220 GI225 GI230 GI235 GI240 GI245 GI250 GI255 GI260 GI265 GI270 GI275 GI280 GI285 GI290 GI295 GI300 GI305 GI310 GI315 GI320 GI325 GI330 GI335 GI340 GI345 GI350 GI355 GI360 GI365 GI370 GI375 GI380 GI385 GI390 GI395 GI400 GI405 GI410 GI415 GI420 GI425 GI430 GI435 GI440 GI445 GI450 GI455 GI460 GI465 GI470 GI475 GI480 GI485 GI490 GI495 GI500 GI505 GI510 GI515 GI520 GI525 GI530 GI535 GI540 GI545 GI550 GI555 GI560 GI565 GI570 GI575 GI580 GI585 GI590 GI595 GI600 GI605 GI610 GI615 GI620 GI625 GI630 GI635 GI640 GI645 GI650 GI655 GI660 GI665 GI670 GI675 GI680 GI685 GI690 GI695 GI700 GI705 GI710 GI715 GI720 GI725 GI730 GI735 GI740 GI745 GI750 GI755 GI760 GI765 GI770 GI775 GI780 GI785 GI790 GI795 GI800 GI805 GI810 GI815 GI820 GI825 GI830 GI835 GI840 GI845 GI850 GI855 GI860 GI865 GI870 GI875 GI880 GI885 GI890 GI895 GI900 GI905 GI910 GI915 GI920 GI925 GI930 GI935 GI940 GI945 GI950 GI955 GI960 GI965 GI970 GI975 GI980 GI985 GI990 GI995 GI1000 GI1005 GI1010 GI1015 GI1020 GI1025 GI1030 GI1035 GI1040 GI1045 GI1050 GI1055 GI1060 GI1065 GI1070 GI1075 GI1080 GI1085 GI1090 GI1095 GI1100 GI1105 GI1110 GI1115 GI1120 GI1125 GI1130 GI1135 GI1140 GI1145 GI1150 GI1155 GI1160 GI1165 GI1170 GI1175 GI1180 GI1185 GI1190 GI1195 GI1200 GI1205 GI1210 GI1215 GI1220 GI1225 GI1230 GI1235 GI1240 GI1245 GI1250 GI1255 GI1260 GI1265 GI1270 GI1275 GI1280 GI1285 GI1290 GI1295 GI1300 GI1305 GI1310 GI1315 GI1320 GI1325 GI1330 GI1335 GI1340 GI1345 GI1350 GI1355 GI1360 GI1365 GI1370 GI1375 GI1380 GI1385 GI1390 GI1395 GI1400 GI1405 GI1410 GI1415 GI1420 GI1425 GI1430 GI1435 GI1440 GI1445 GI1450 GI1455 GI1460 GI1465 GI1470 GI1475 GI1480 GI1485 GI1490 GI1495 GI1500 GI1505 GI1510 GI1515 GI1520 GI1525 GI1530 GI1535 GI1540 GI1545 GI1550 GI1555 GI1560 GI1565 GI1570 GI1575 GI1580 GI1585 GI1590 GI1595 GI1600 GI1605 GI1610 GI1615 GI1620 GI1625 GI1630 GI1635 GI1640 GI1645 GI1650 GI1655 GI1660 GI1665 GI1670 GI1675 GI1680 GI1685 GI1690 GI1695 GI1700 GI1705 GI1710 GI1715 GI1720 GI1725 GI1730 GI1735 GI1740 GI1745 GI1750 GI1755 GI1760 GI1765 GI1770 GI1775 GI1780 GI1785 GI1790 GI1795 GI1800 GI1805 GI1810 GI1815 GI1820 GI1825 GI1830 GI1835 GI1840 GI1845 GI1850 GI1855 GI1860 GI1865 GI1870 GI1875 GI1880 GI1885 GI1890 GI1895 GI1900 GI1905 GI1910 GI1915 GI1920 GI1925 GI1930 GI1935 GI1940 GI1945 GI1950 GI1955 GI1960 GI1965 GI1970 GI1975 GI1980 GI1985 GI1990 GI1995 GI2000 GI2005 GI2010 GI2015 GI2020 GI2025 GI2030 GI2035 GI2040 GI2045 GI2050 GI2055 GI2060 GI2065 GI2070 GI2075 GI2080 GI2085 GI2090 GI2095 GI2100 GI2105 GI2110 GI2115 GI2120 GI2125 GI2130 GI2135 GI2140 GI2145 GI2150 GI2155 GI2160 GI2165 GI2170 GI2175 GI2180 GI2185 GI2190 GI2195 GI2200 GI2205 GI2210 GI2215 GI2220 GI2225 GI2230 GI2235 GI2240 GI2245 GI2250 GI2255 GI2260 GI2265 GI2270 GI2275 GI2280 GI2285 GI2290 GI2295 GI2300 GI2305 GI2310 GI2315 GI2320 GI2325 GI2330 GI2335 GI2340 GI2345 GI2350 GI2355 GI2360 GI2365 GI2370 GI2375 GI2380 GI2385 GI2390 GI2395 GI2400 GI2405 GI2410 GI2415 GI2420 GI2425 GI2430 GI2435 GI2440 GI2445 GI2450 GI2455 GI2460 GI2465 GI2470 GI2475 GI2480 GI2485 GI2490 GI2495 GI2500 GI2505 GI2510 GI2515 GI2520 GI2525 GI2530 GI2535 GI2540 GI2545 GI2550 GI2555 GI2560 GI2565 GI2570 GI2575 GI2580 GI2585 GI2590 GI2595 GI2600 GI2605 GI2610 GI2615 GI2620 GI2625 GI2630 GI2635 GI2640 GI2645 GI2650 GI2655 GI2660 GI2665 GI2670 GI2675 GI2680 GI2685 GI2690 GI2695 GI2700 GI2705 GI2710 GI2715 GI2720 GI2725 GI2730 GI2735 GI2740 GI2745 GI2750 GI2755 GI2760 GI2765 GI2770 GI2775 GI2780 GI2785 GI2790 GI2795 GI2800 GI2805 GI2810 GI2815 GI2820 GI2825 GI2830 GI2835 GI2840 GI2845 GI2850 GI2855 GI2860 GI2865 GI2870 GI2875 GI2880 GI2885 GI2890 GI2895 GI2900 GI2905 GI2910 GI2915 GI2920 GI2925 GI2930 GI2935 GI2940 GI2945 GI2950 GI2955 GI2960 GI2965 GI2970 GI2975 GI2980 GI2985 GI2990 GI2995 GI3000 GI3005 GI3010 GI3015 GI3020 GI3025 GI3030 GI3035 GI3040 GI3045 GI3050 GI3055 GI3060 GI3065 GI3070 GI3075 GI3080 GI3085 GI3090 GI3095 GI3100 GI3105 GI3110 GI3115 GI3120 GI3125 GI3130 GI3135 GI3140 GI3145 GI3150 GI3155 GI3160 GI3165 GI3170 GI3175 GI3180 GI3185 GI3190 GI3195 GI3200 GI3205 GI3210 GI3215 GI3220 GI3225 GI3230 GI3235 GI3240 GI3245 GI3250 GI3255 GI3260 GI3265 GI3270 GI3275 GI3280 GI3285 GI3290 GI3295 GI3300 GI3305 GI3310 GI3315 GI3320 GI3325 GI3330 GI3335 GI3340 GI3345 GI3350 GI3355 GI3360 GI3365 GI3370 GI3375 GI3380 GI3385 GI3390 GI3395 GI3400 GI3405 GI3410 GI3415 GI3420 GI3425 GI3430 GI3435 GI3440 GI3445 GI3450 GI3455 GI3460 GI3465 GI3470 GI3475 GI3480 GI3485 GI3490 GI3495 GI3500 GI3505 GI3510 GI3515 GI3520 GI3525 GI3530 GI3535 GI3540 GI3545 GI3550 GI3555 GI3560 GI3565 GI3570 GI3575 GI3580 GI3585 GI3590 GI3595 GI3600 GI3605 GI3610 GI3615 GI3620 GI3625 GI3630 GI3635 GI3640 GI3645 GI3650 GI3655 GI3660 GI3665 GI3670 GI3675 GI3680 GI3685 GI3690 GI3695 GI3700 GI3705 GI3710 GI3715 GI3720 GI3725 GI3730 GI3735 GI3740 GI3745 GI3750 GI3755 GI3760 GI3765 GI3770 GI3775 GI3780 GI3785 GI3790 GI3795 GI3800 GI3805 GI3810 GI3815 GI3820 GI3825 GI3830 GI3835 GI3840 GI3845 GI3850 GI3855 GI3860 GI3865 GI3870 GI3875 GI3880 GI3885 GI3890 GI3895 GI3900 GI3905 GI3910 GI3915 GI3920 GI3925 GI3930 GI3935 GI3940 GI3945 GI3950 GI3955 GI3960 GI3965 GI3970 GI3975 GI3980 GI3985 GI3990 GI3995 GI4000 GI4005 GI4010 GI4015 GI4020 GI4025 GI4030 GI4035 GI4040 GI4045 GI4050 GI4055 GI4060 GI4065 GI4070 GI4075 GI4080 GI4085 GI4090 GI4095 GI4100 GI4105 GI4110 GI4115 GI4120 GI4125 GI4130 GI4135 GI4140 GI4145 GI4150 GI4155 GI4160 GI4165 GI4170 GI4175 GI4180 GI4185 GI4190 GI4195 GI4200 GI4205 GI4210 GI4215 GI4220 GI4225 GI4230 GI4235 GI4240 GI4245 GI4250 GI4255 GI4260 GI4265 GI4270 GI4275 GI4280 GI4285 GI4290 GI4295 GI4300 GI4305 GI4310 GI4315 GI4320 GI4325 GI4330 GI4335 GI4340 GI4345 GI4350 GI4355 GI4360 GI4365 GI4370 GI4375 GI4380 GI4385 GI4390 GI4395 GI4400 GI4405 GI4410 GI4415 GI4420 GI4425 GI4430 GI4435 GI4440 GI4445 GI4450 GI4455 GI4460 GI4465 GI4470 GI4475 GI4480 GI4485 GI4490 GI4495 GI4500 GI4505 GI4510 GI4515 GI4520 GI4525 GI4530 GI4535 GI4540 GI4545 GI4550 GI4555 GI4560 GI4565 GI4570 GI4575 GI4580 GI4585 GI4590 GI4595 GI4600 GI4605 GI4610 GI4615 GI4620 GI4625 GI4630 GI4635 GI4640 GI4645 GI4650 GI4655 GI4660 GI4665 GI4670 GI4675 GI4680 GI4685 GI4690 GI4695 GI4700 GI4705 GI4710 GI4715 GI4720 GI4725 GI4730 GI4735 GI4740 GI4745 GI4750 GI4755 GI4760 GI4765 GI4770 GI4775 GI4780 GI4785 GI4790 GI4795 GI4800 GI4805 GI4810 GI4815 GI4820 GI4825 GI4830 GI4835 GI4840 GI4845 GI4850 GI4855 GI4860 GI4865 GI4870 GI4875 GI4880 GI4885 GI4890 GI4895 GI4900 GI4905 GI4910 GI4915 GI4920 GI4925 GI4930 GI4935 GI4940 GI4945 GI4950 GI4955 GI4960 GI4965 GI4970 GI4975 GI4980 GI4985 GI4990 GI4995 GI5000 GI5005 GI5010 GI5015 GI5020 GI5025 GI5030 GI5035 GI5040 GI5045 GI5050 GI5055 GI5060 GI5065 GI5070 GI5075 GI5080 GI5085 GI5090 GI5095 GI5100 GI5105 GI5110 GI5115 GI5120 GI5125 GI5130 GI5135 GI5140 GI5145 GI5150 GI5155 GI5160 GI5165 GI5170 GI5175 GI5180 GI5185 GI5190 GI5195 GI5200 GI5205 GI5210 GI5215 GI5220 GI5225 GI5230 GI5235 GI5240 GI5245 GI5250 GI5255 GI5260 GI5265 GI5270 GI5275 GI5280 GI5285 GI5290 GI5295 GI5300 GI5305 GI5310 GI5315 GI5320 GI5325 GI5330 GI5335 GI5340 GI5345 GI5350 GI5355 GI5360 GI5365 GI5370 GI5375 GI5380 GI5385 GI5390 GI5395 GI5400 GI5405 GI5410 GI5415 GI5420 GI5425 GI5430 GI5435 GI5440 GI5445 GI5450 GI5455 GI5460 GI5465 GI5470 GI5475 GI5480 GI5485 GI5490 GI5495 GI5500 GI5505 GI5510 GI5515 GI5520 GI5525 GI5530 GI5535 GI5540 GI5545 GI5550 GI5555 GI5560 GI5565 GI5570 GI5575 GI5580

ROBOT SOLUTION

Option quick-reference table

Software options					
	RC700-A	RC700-D	RC90-B	T series	VT
02 Vision Guide 7.0	●	●	●	●	●
03 Force Guide 7.0	●	●	—	—	—
RC+ API 7.0	●	●	●	●	●
ECP	●	●	●	●	●
GUI Builder 7.0	●	●	●	●	●
OCR	●	●	●	●	●
VRT	●	●	●	●	●

Controller options					
	RC700-A	RC700-D	RC90-B	T series	VT
04 Teaching Pendant (TP2)	●	●	●	●	●
04 Teaching Pendant (TP3)	●	●	—	●	●
05 Conveyor tracking	●	●	●	—	—
05 PG motion system	●	●	●	—	—
06 Emergency stop switch	●	●	●	●	●
07 RS-232C cards	●	●	●	—	—
08 I/O expansion cards	●	●	●	—	—
09 Fieldbus I/O (Slave)	●	●	●	●	●
10 Fieldbus I/O (Master)	●	●	●	●	●
11 Analog I/O card	●	●	●	—	—
12 EUROMAP 67 card	●	●	●	—	—
13 I/O cable kit	●	●	●	—	—
14 Hot plug kit	●	●	—	●	●
15 Wall mount option	●	●	—	—	—

Manipulator options															
	G1	G3	G4	G6	G8	G10/G20	LS3/L6/LS10/LS20	T3-B/T8-B	RS3/RS4	C4	C8	N2	N6	V16	
16 External wiring units	—	—	—	●	●	●	—	—	—	—	—	—	—	●	
17 Internal wiring unit	—	—	—	—	—	—	—	—	●	—	—	—	—	—	
18 Tool adapters/ISO flanges	—	●	●	●	●	●	●	●	●	—	●	●	●	●	
20 Brake release units	—	—	—	—	—	—	—	—	—	●	●	●	●	—	
21 Power and signal cables	●	●	●	●	●	●	●	(built-in controller)	●	●	●	●	●	(built-in controller)	
Cable length (m)	3,5,10,15,20						3,5,10		3,5,10,15,20						
Cable type (Standard/High-flex)	Standard								Standard	Standard/High-flex	Standard	Standard/High-flex			
23 Power cable connectors (Straight/L-type)	Straight/L-type						Standard		Straight/L-type						
23 Camera mounting bracket	—	●	●	●	●	●	●	●	●	●	●	●	●	●	
RC700DU-A (Drive unit)	●	●	—	●	—	●	—	—	●	●	●	—	●	—	

ROBOT SOLUTION

Option setup example

RC700-A controller with C series robots

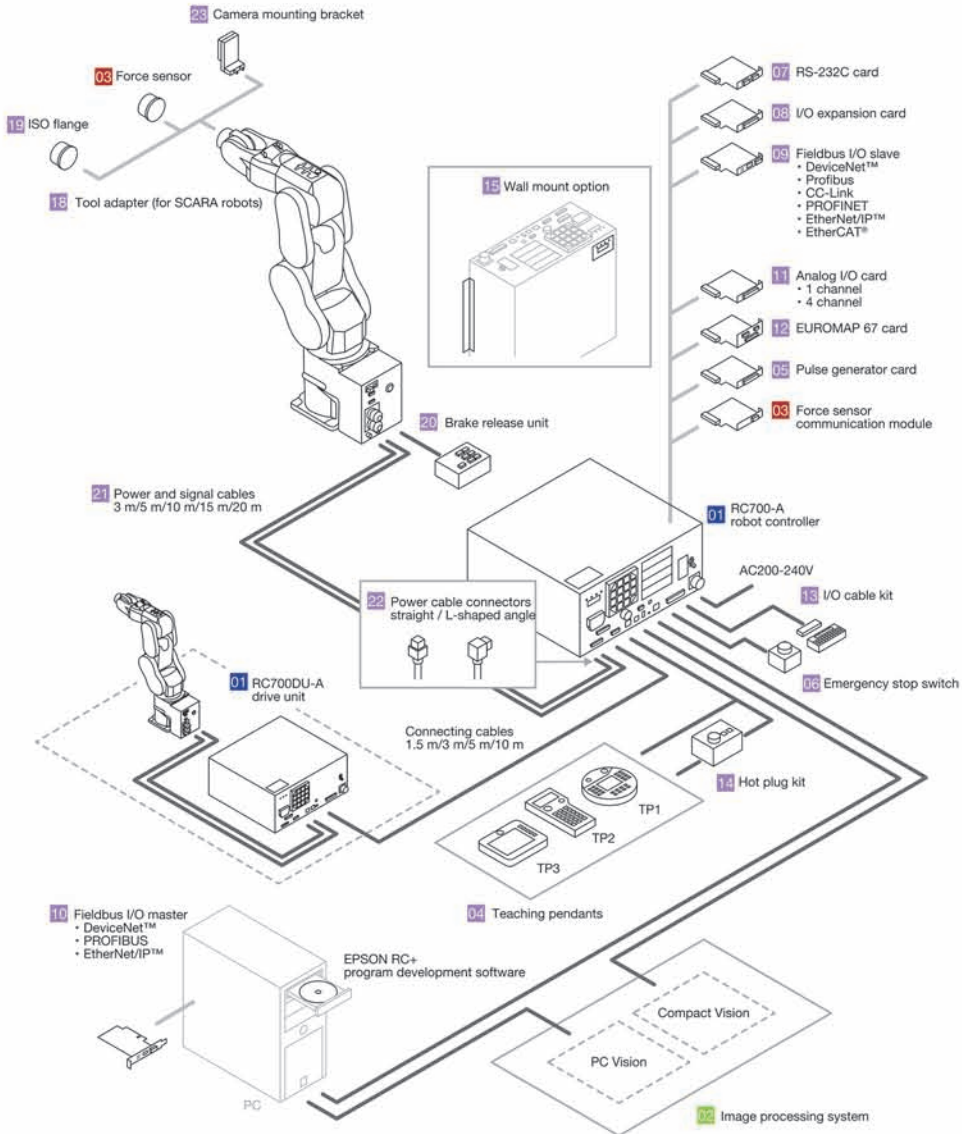

ROBOT SOLUTION

Option setup example

RC90-B controller

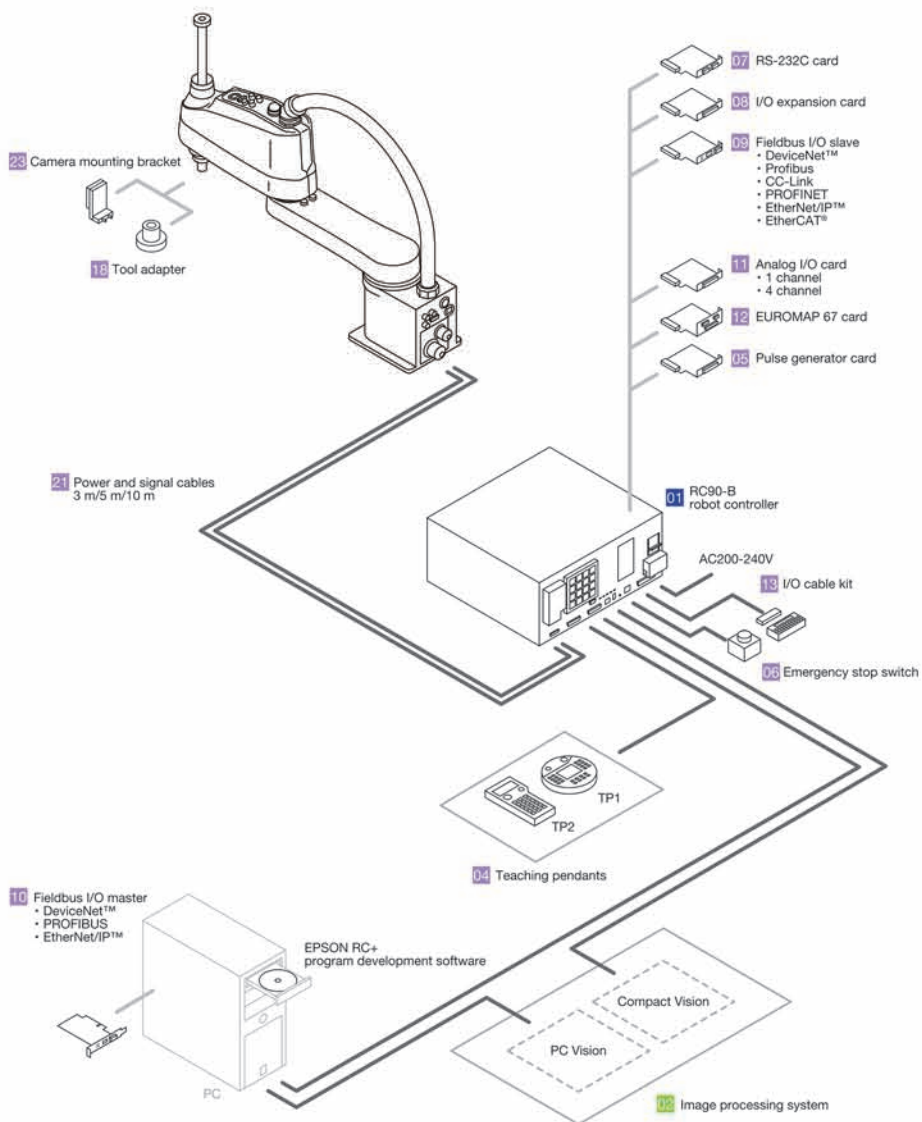

ROBOT SOLUTION

T series robot

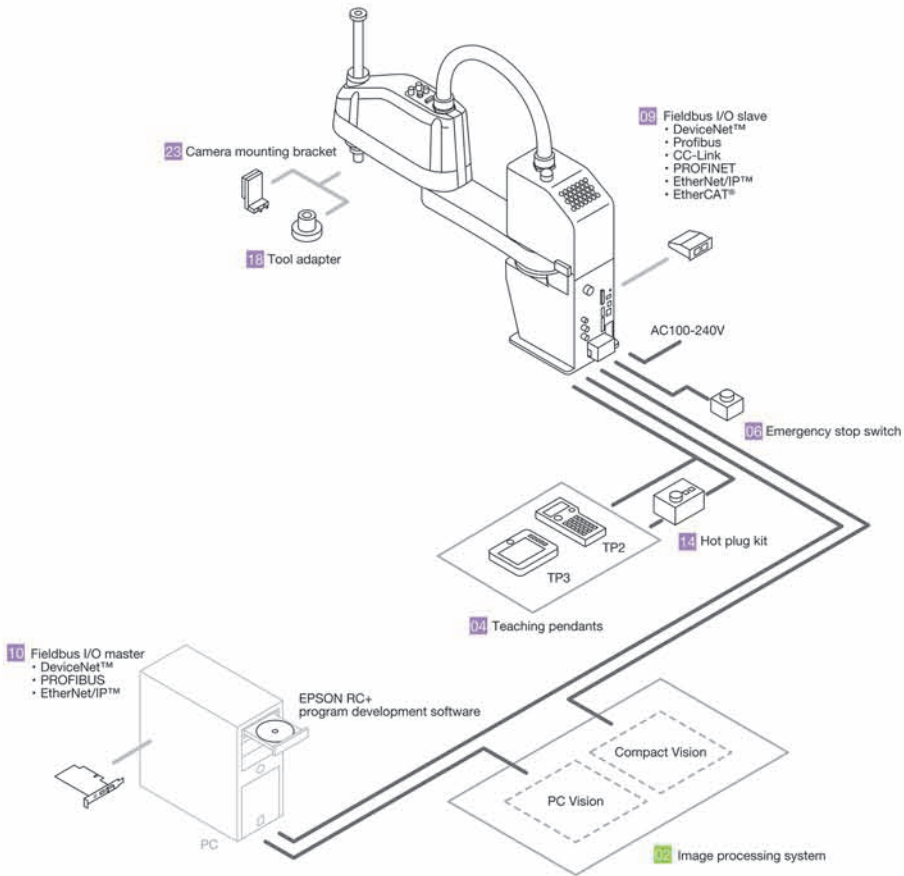

ROBOT SOLUTION

Option setup example

VT series robot

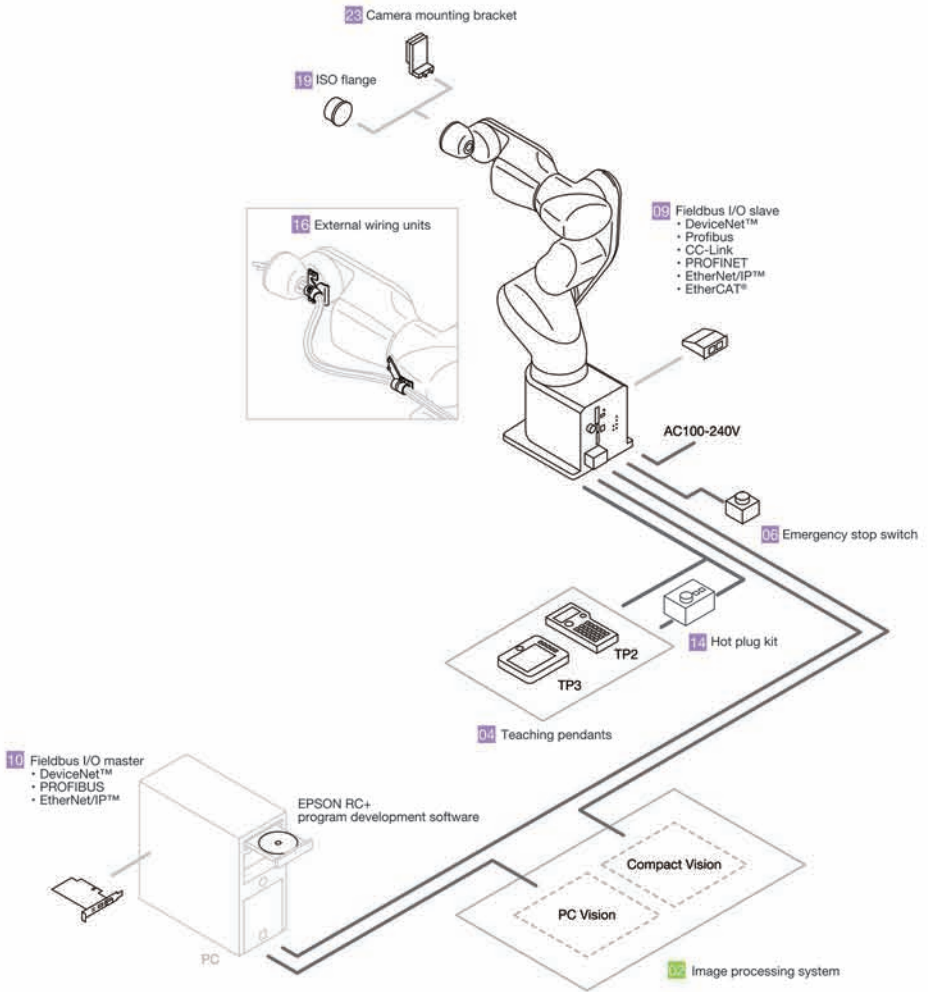

BRINGING AUTOMATION TO THE NEXT LEVEL.



ROBOT SOLUTION

Epson Robots are built for greater efficiency and precision while fusing form and function. Equipped with an optional complementary force sensor that is both sensitive and versatile, the robots are capable of executing a wide range of high precision tasks. Details make all the difference in the world of automation. Experience lower production costs, enhanced quality and increased productivity with Epson's highly reliable robots, while increasing businesses' bottom line.



ENGINEERED FOR good

EPSON

TRANSFORMATION. DETAILS MAKE THE DIFFERENCE.

ROBOT SOLUTION

All-in-one SCARA T3

Space-saving compact design, built-in controller for simple configuration – ensures high productivity with minimum downtime, significantly reducing total cost of ownership.

Folding-arm 6-Axis N2

All-new folding arm mechanism – a world first in 6-axis robot design – enables complex, high-precision assembly tasks to be performed in extremely limited spaces.

Compact 6-Axis C8

High performance in a slimline package, allows payloads up to 8Kg while maintaining fast speeds and cycle times. Water and dust resistant. Can be wall or ceiling mounted.

Long-reach SCARA LS6

Added reach and payload capacity, small footprint, proven reliability with outstanding functionality and cost-performance for pick-and-place and assembly tasks.

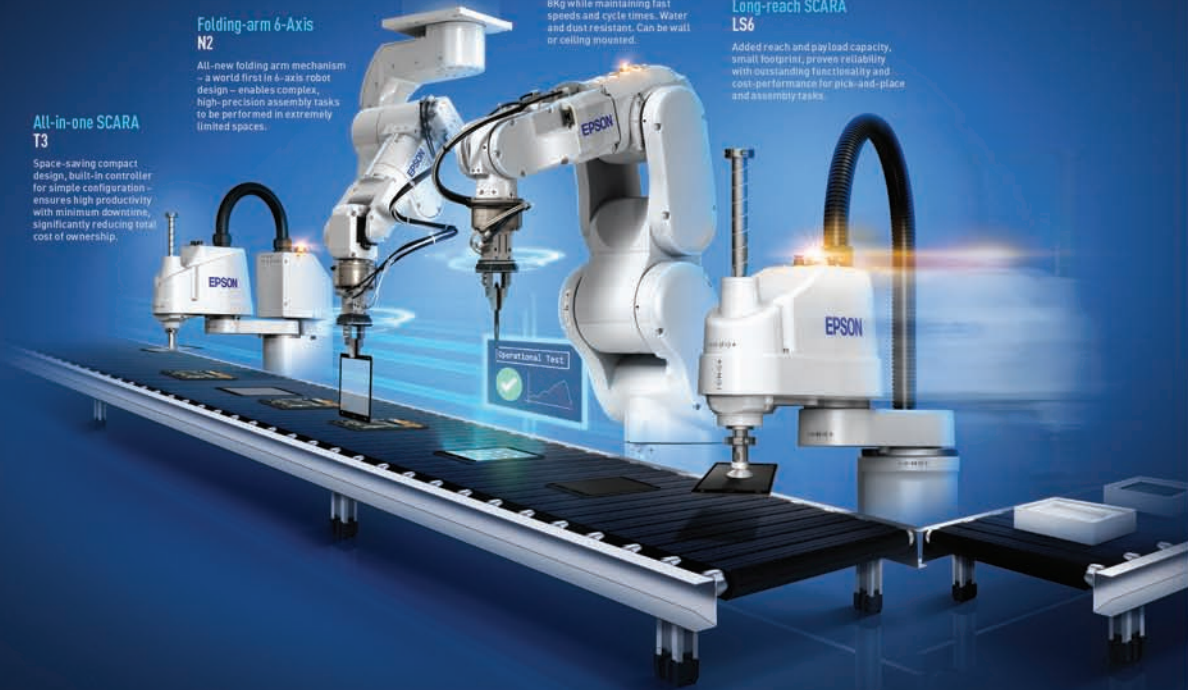

Enjoy the advantages of automation with Epson Robots.

Some manufacturing industries seek automation, but require the tools to upgrade from manual production. Others want to learn more about the possibilities and benefits of automation before progressing.

Whatever stage you're at right now, take a look at the advantages of the industry-changing technology built into Epson robots. With incredible sensitivity, our amazingly-precise, outstandingly-reliable robots complete tasks that previously defied automation. Enabling solutions that increase your productivity and enhance your reputation, while reducing your costs.

Transform your production line and your bottom line, with Epson.
Remember, it's in the details. epson.co.id/industrial-robots

ENGINEERED FOR good

EPSON